

WIZARDING
WORLD

Harry Potter

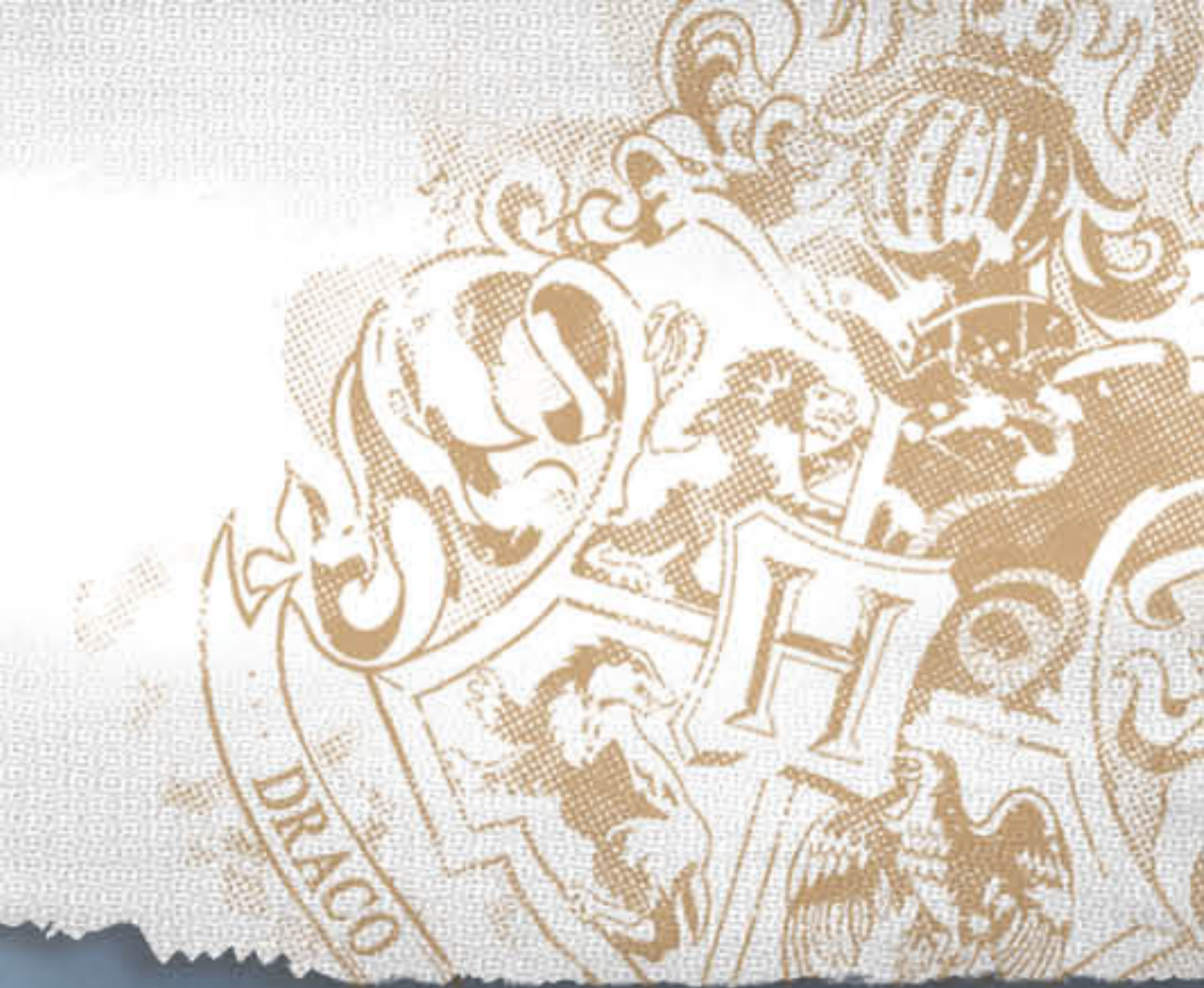

Find out MORE

Assemble me.
Welcome to the
school for witches
and wizards!

UGEARS

Mechanical models

HOGWARTS™ CASTLE
ЗАМОК ГОГВОРТСЬ™

FRA Chateau de Poudlard™ DEU Schloss Hogwarts™
SPA Castillo de Hogwarts™ ITA Castello di Hogwarts™
JPN ホグワーツ™城 CHI 霍格沃茨™城堡
POR Castelo de Hogwarts™ POL Zamek Hogwart™
KOR 호그와트™ 캐슬

Assembly instructions

Інструкція зі складання

FRA Notice d'assemblage. DEU Aufbauanleitung.
SPA Instrucciones de montaje. ITA Istruzioni di montaggio.
JPN 組み立て説明書 CHI 装配说明书 POR Instruções de montagem.
POL Instrukcja montażu. KOR 조립 설명서.



MECHANICAL
МЕХАНІЧНИ



NO GLUE CONNECTION
БЕЗ КЛЕЮ



PLYWOOD
З ФАНЕРИ

ENG

Assembly instructions:

Remove model parts from the hanger board as illustrated below. Careful not to break parts. If a part does not remove easily, carefully cut it out with a knife. This model is intended for self-assembly without glue. If you have difficulty installing the axles, try waxing them with a regular candle. All moving parts can also be waxed during assembly to reduce friction when operating the model.

UKR

Інструкція зі складання:

Витягніть з дошки позначені на схемі деталі. Намагайтеся їх не зламати. Якщо деталь не виймається, надсічіть перемички ножем. Конструкція збирається без клею. У разі виникнення труднощів з протягуванням вісі в отвір, потріть деталь об звичайну свічку. Також можна змастити свічкою всі деталі механізму, що рухаються, щоб зменшити тертя при обертанні.

FRA

Notice d'assemblage:

Faites sortir de la planche les pièces comme indiquées sur le schéma. Tâchez de ne pas les casser. Si la pièce ne sort pas, incisez les collages/fixations avec un couteau. La construction est à assembler sans colle. Si il est difficile d'introduire l'axe en bois dans l'orifice, frottez au préalable l'axe ou les pièces contre une bougie. Pour améliorer le glissement, traitez les pièces de frottement mobiles du mécanisme avec une bougie au cours d'assemblage.

DEU

Aufbauanleitung:

Bitte die in der Zeichnung angegebenen Teile aus der Platte herausnehmen. Versuchen Sie bitte diese nicht zu brechen. Wenn sich ein Teil nicht herausnehmen lässt, schneiden Sie die Stege mit dem Messer leicht an. Das Modell wird ohne Klebstoffe zusammengebaut. Lässt sich eine Achse nur schwer in eine Öffnung einführen, reiben Sie diese mit einer Kerze etwas ein. Für besseres Gleiten schmieren Sie alle beweglichen Teile mit einer Kerze.

SPA

Instrucciones de montaje:

Saque de la tabla las piezas marcadas en el esquema. Trate de no romperlas. Si una pieza no se saca, haga una incisión. La construcción va sin pegamento. Si tiene dificultades con la instalación del eje de madera en un agujero, frote primero el eje o las piezas contra una vela. Para un mejor deslizamiento, lubrique durante el montaje las piezas móviles del mecanismo con una vela común.

ITA

Istruzioni di montaggio:

Estrarre dal telaio i particolari indicati nello schema. Fare attenzione a non romperli. Se un particolare non si stacca, tagliare delicatamente gli elementi di collegamento con un coltello. L'assieme viene realizzato senza colla. In caso di difficoltà nell'inserimento di un perno in legno, è necessario sfregare il perno o il particolare con un po' di cera. Per uno scorrimento migliore incerare le parti mobili del meccanismo durante l'assemblaggio.

JPN

組み立て説明書:

部品に傷をつけないように注意しながらボードから外してください。部品が外れにくい場合は連結部分をカッターで切ってから外すと外しやすいです。本製品は、接着剤がなくても組み立てができるように設計されています。もしアクスル(駆動部)が、歯車の動きがにぶい場合は、ロウソクをアクスルに塗ってください。全ての駆動部分は製品を動かす時、滑らかに動くように潤滑剤であるロウソクを塗りながら組み立てます。

CHI

装配说明

将模型部件按插图示，从胶合板取下。小心不要损坏件。如果取下时候有难度，请用小刀小心的切割连接点。这个产品不需要胶水粘接。如果安装转轴的时候有难度，请用普通的蜡加以润滑。所有的转动部分也需要打蜡润滑。

POR

Instruções de montagem:

Remova as peças do modelo da placa de suporte, conforme ilustrado abaixo, tomando cuidado para não quebrar as peças. Se uma peça não sair facilmente, corte-a cuidadosamente com uma faca. Este modelo foi feito para ser montado sem necessidade de usar cola. Se você tiver dificuldade em instalar os eixos, tente adicionar um pouco de cera como a de uma vela comum. Todas as peças móveis também podem ser enceradas durante a montagem para reduzir o atrito ao usar o modelo.

POL

Instrukcja montażu:

Delikatnie wyciągaj z deseczki wskazane w schemacie detale, starając się nie połamać elementów. Jeśli detal nie poddaje się, podetnij wiązadła nożem. Konstrukcje składa się bez kleju. Jeśli napotkasz trudności z instalacją drewnianej osi w otwórce, potrzyj na początku oś lub detale o woskową świecę. Dla lepszego poślizgu polecano smarowanie ruchomych części mechanizmu zwykłą świecą podczas montażu.

KOR

조립 설명:

부품이 손상되지 않도록 주의하여 보드에서 떼어냅니다. 만약 부품이 잘 떨어지지 않으면 연결 부분을 칼로 절단 한 후 떼어내면 쉽게 떼어 낼 수 있습니다. 본 제품은 접착제가 없이 조립이 가능하도록 설계되어 있습니다. 만약 축이 잘 끼워지지 않는 경우 양초를 축에 바른 후 끼워 보세요. 모든 구동 부위는 제품 구동 시 원활한 작동이 가능하도록 조립 과정에서 윤활제(양초)양초를 발라 주세요.

ENG Warning! UKR Увага! FRA Attention! DEU Achtung! SPA Precaución!
ITA Attenzione! JPN 注意! CHI 注意! POR Atenção! POL Uwaga! KOR 주의!



ENG Do not use a lighted candle! UKR Не підпалювати!
FRA Ne pas brûler! DEU Nicht anzünden! SPA ¡No encender! ITA Non dare fuoco!
JPN 火のついたロウソクの使用はお止めください。
CHI 请勿点燃，请勿靠近火源！
POR Não use uma vela acesa para este propósito!
POL Nie podpalać! KOR 불이 붙은 초를 이용하지 마세요!

ENG Customer support UKR Служба підтримки FRA Service client DEU Kundendienst SPA Servicio al cliente
ITA Servizio di supporto JPN 客様窓口 CHI 客户支持 POR Atendimento ao cliente POL Wsparcie klienta KOR 고객지원
customerservice@ugearsmodels.com



ENG Wax the part with a regular candle (rub with a candle). UKR Змастіть деталь звичайною свічкою (потріть об свічку). FRA Lubrifiez la pièce avec une bougie ordinaire (frottez contre la bougie). DEU Reiben Sie das Teil mit einer einfachen Kerze etwas ein. SPA Engrase la pieza con una vela común (frote con una vela). ITA Incerare il componente (Sfregare con la cera). JPN された部分に潤滑剤としてロウソクを塗ってください。CHI 用普通蜡烛涂抹润滑部件 POR Encere a peça com uma vela comum (esfregue em uma vela). POL Przesmaruj zwykłą świecą. KOR 표시된 부분에 윤활을 위해 초를 칠해 주세요.



ENG Pay attention. Check position of the part. UKR Зверніть увагу. Перевірте розташування елемента. FRA Faites attention. Vérifiez l'adispotion de l'élément. DEU Bitte Beachten. Prüfen Sie die Einbaulage des Elementes. SPA Atención. Compruebe la situación del elemento. ITA Prestare attenzione. Controllare la posizione del componente. JPN 方向及び位置に注意して組み立てて下さい。CHI 注意! 检查部件方向和位置 POR Preste atenção à posição da peça. POL Zwróć uwagę. Sprawdź lokalizację elementu. KOR 방향 또는 위치에 주의해서 조립해 주세요.



ENG Check the mechanism for smoothness and accuracy of movement. Operate the mechanism so the parts would seat-in. UKR Перевірте механізм на плавність і точність ходу. Розробіть механізм. FRA Vérifiez si le mécanisme fonctionne en douceur et avec précision. Faites fonctionner le mécanisme jusqu'à son fonctionnement normal. DEU Prüfen sie den Mechanismus bezüglich der Laufruhe und der Genauigkeit des Ganges. Betätigen Sie den Mechanismus mehrmals. SPA Verifique la suavidad y precisión del mecanismo. Desarrolle el mecanismo. ITA Controllare la scorrevolezza e la precisione del movimento. Far funzionare il meccanismo. JPN 駆動部分が滑らかに動くかを確認しながら作業をすすめます。CHI 检查机构的运行平稳度和精确度。调整机构。POR Teste a suavidade e precisão do movimento do mecanismo. Opere o mecanismo para que as peças se encaixem. POL Sprawdź plynność i dokładność ruchu mechanizmu. Dopracuj mechanizm. KOR 구동 부분의 원활한 작동과 정확한 움직임을 확인하세요.

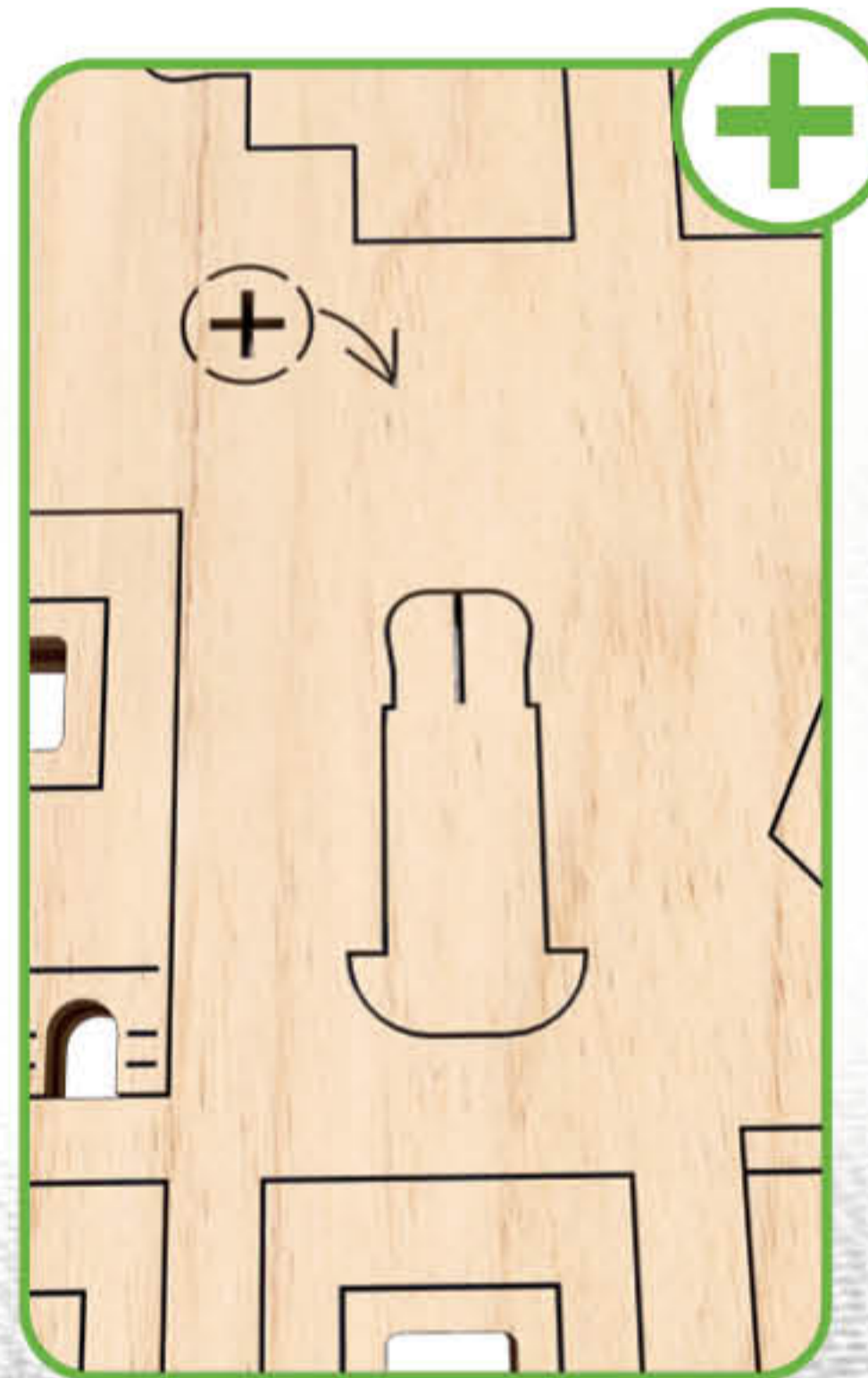

Specified details come with spare duplicates. UKR Зазначені деталі є на дошках як запасні. FRA Les détails spécifiques sont fournis avec des doublons de rechange. DEU Die angegebenen Details werden mit Ersatzduplikaten geliefert. SPA Los detalles especificados vienen con duplicados de repuesto. ITA I dettagli specificati vengono forniti con duplicati di riserva. JPN 指定された詳細には予備の複製が付属しています。CHI 指定的細節帶有備用副本。POR Os detalhes especificados vêm com peças sobressalentes duplicadas. POL Zapasowe elementy są zaznaczone na desce. KOR 명시된 세부 사항은 여분의 복사본과 함께 제공됩니다.

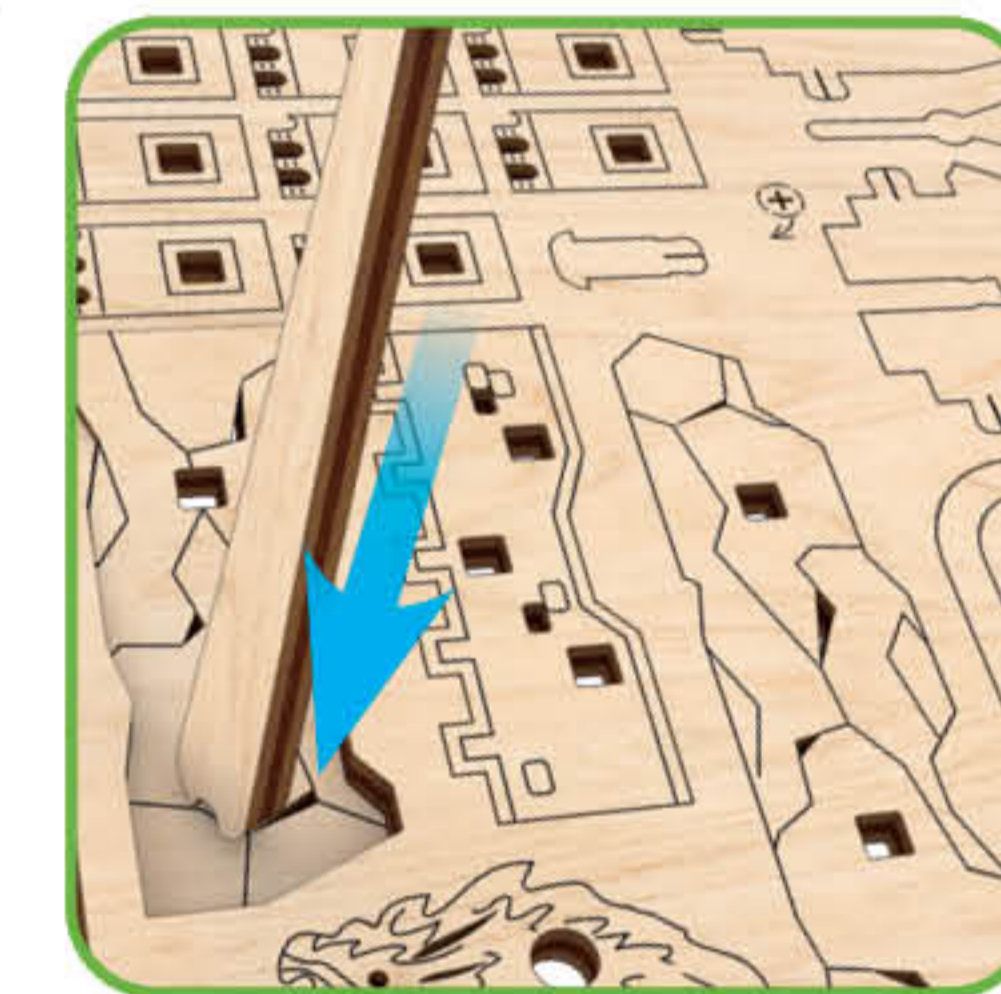
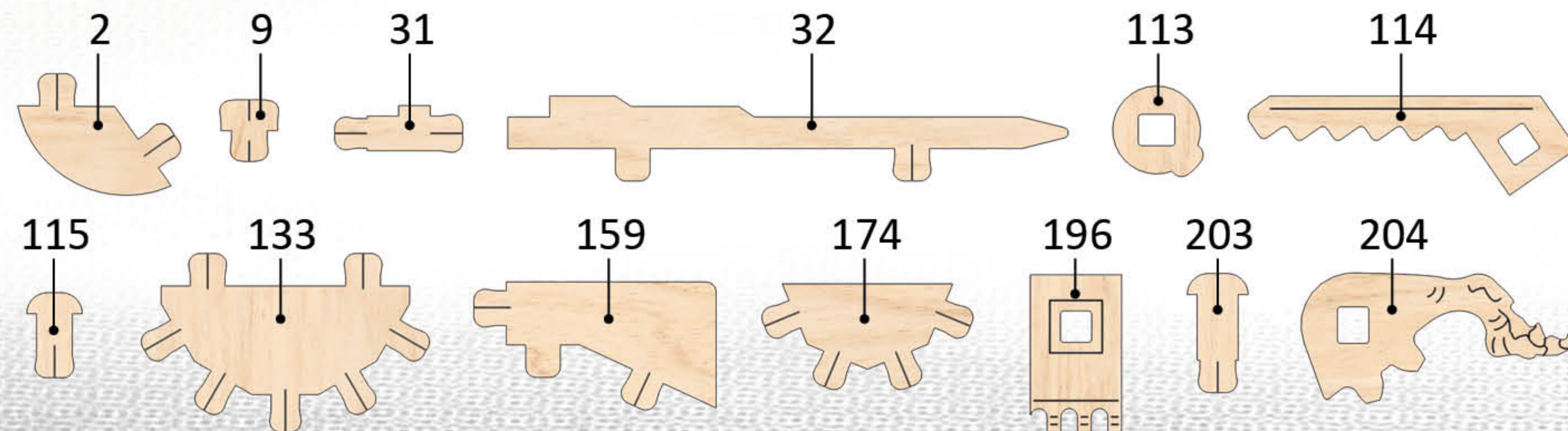

ENG This is not a structural component; it is a tool or measurement and assembly. UKR Це не деталь конструкції, а допоміжний інструмент для складання або вимірювання відстаней. FRA Cette pièce ne fait pas partie de la construction mais constitue un outil annexe pour l'assemblage ou la mesure des distances. DEU Es ist kein Teil der Konstruktion, sondern ein Hilfselement für den Zusammenbau oder für das Messen der Abstände. SPA No es una pieza de la construcción sino un instrumento auxiliar para montar o para medir distancias. ITA Non è un componente del modello, ma un'attrezzatura aggiuntiva per il montaggio o il rilievo delle quote. JPN この部品は完成時の部品ではなく、組み立てをサポートしたり測定する道具です。CHI 这不是装配零部件，是一种测量及安装辅助工具。POR Este não é um componente estrutural, é uma ferramenta para medição e montagem. POL To nie detal konstrukcji, a pomocnicze narzędzie dla montażu i wymiaru odległości. KOR 이 부품은 조립을 위한 부품이 아니고 조립을 돕거나 측정을 위한 도구입니다.

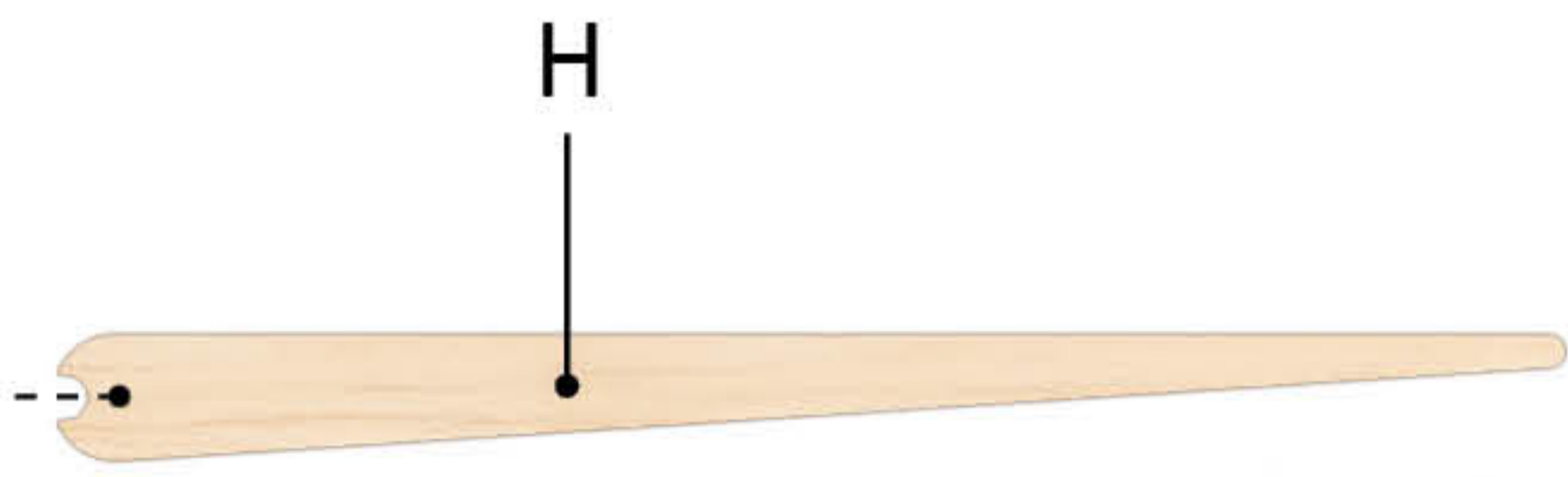
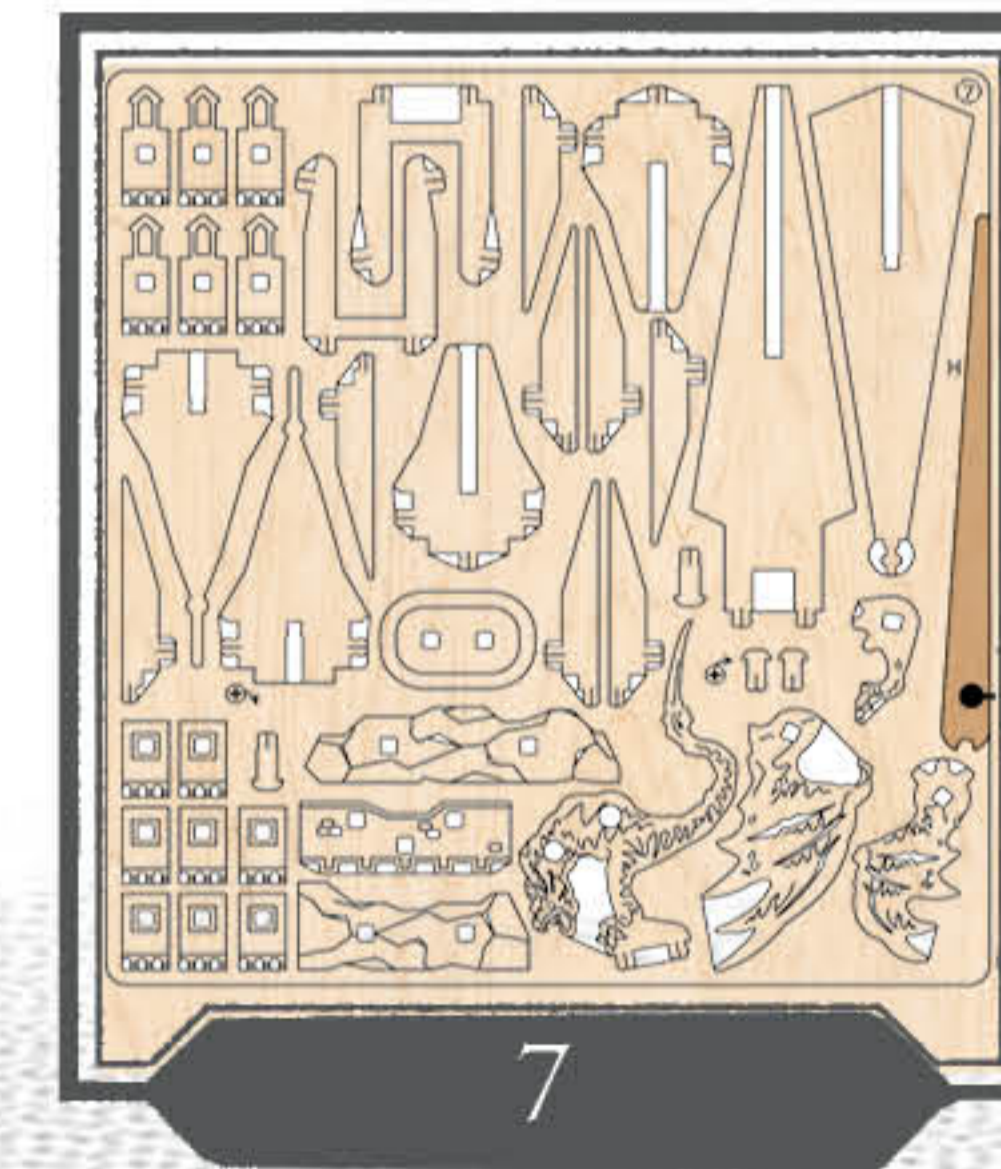

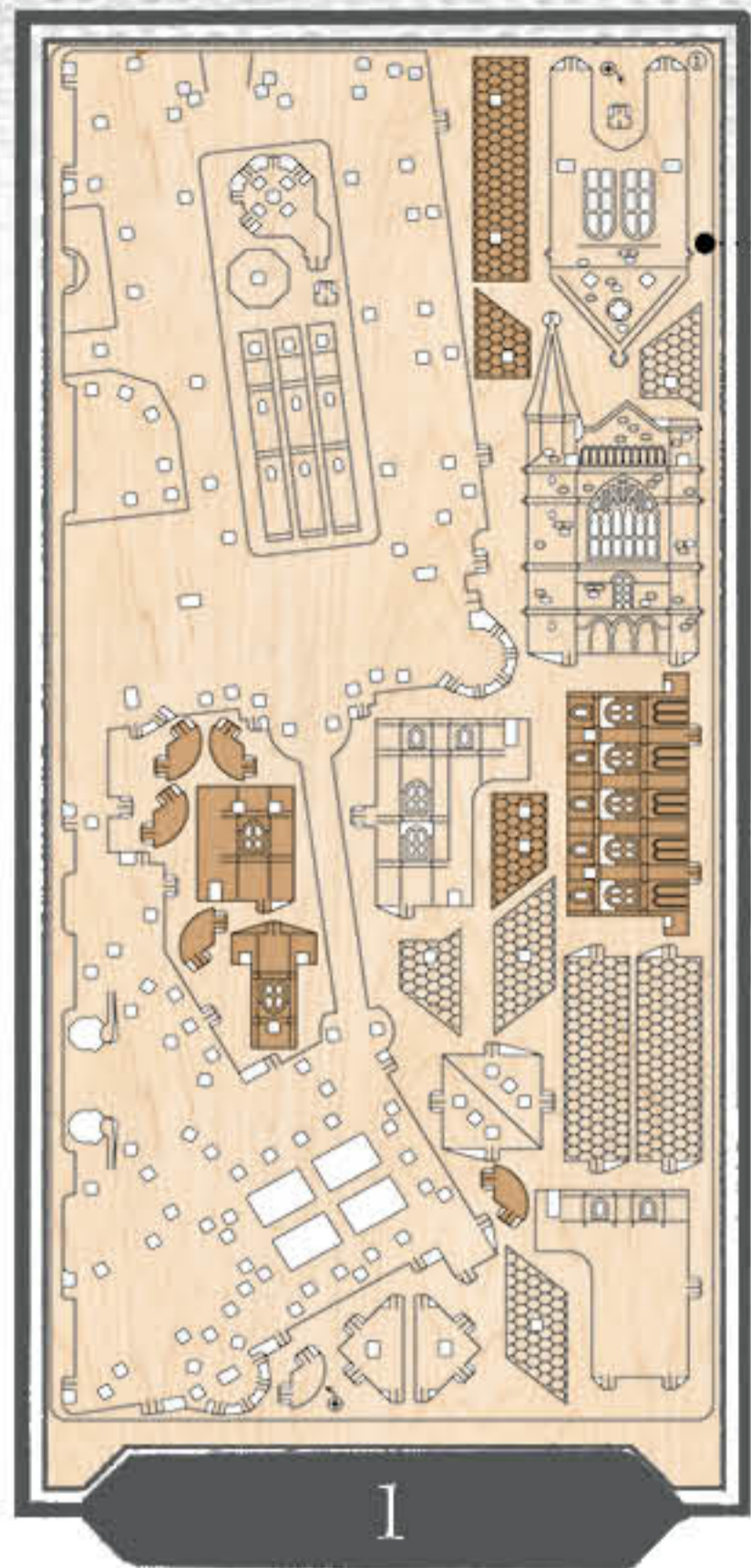

It's easier to pull out some parts with the «helper (H)». UKR Буде легше видавити готові деталі за допомогою «helper (H)». FRA Il est plus facile de retirer certaines pièces avec la pièce-outils (H). DEU Es ist einfacher, einige Teile mit dem "Helfer (H)" herauszunehmen. Siehe Beispiel: SPA Para separar algunas partes resulta más fácil utilizando la ayuda del elemento "H". ITA È più facile estrarre alcuni elementi utilizzando l' "aiuto (H)". JPN ある部品は「helper (H)」を使うと取り外しやすいです。CHI 使用「helper H」可以更容易地拉出某些零件。POR É mais fácil retirar algumas peças usando a «peça auxiliar(H)». POL Niektóre części łatwiej jest wyciągnąć za pomocą "pomocnika (H)". KOR 일부 부품은 'H' 도구를 이용하여 떼어내면 쉽습니다.

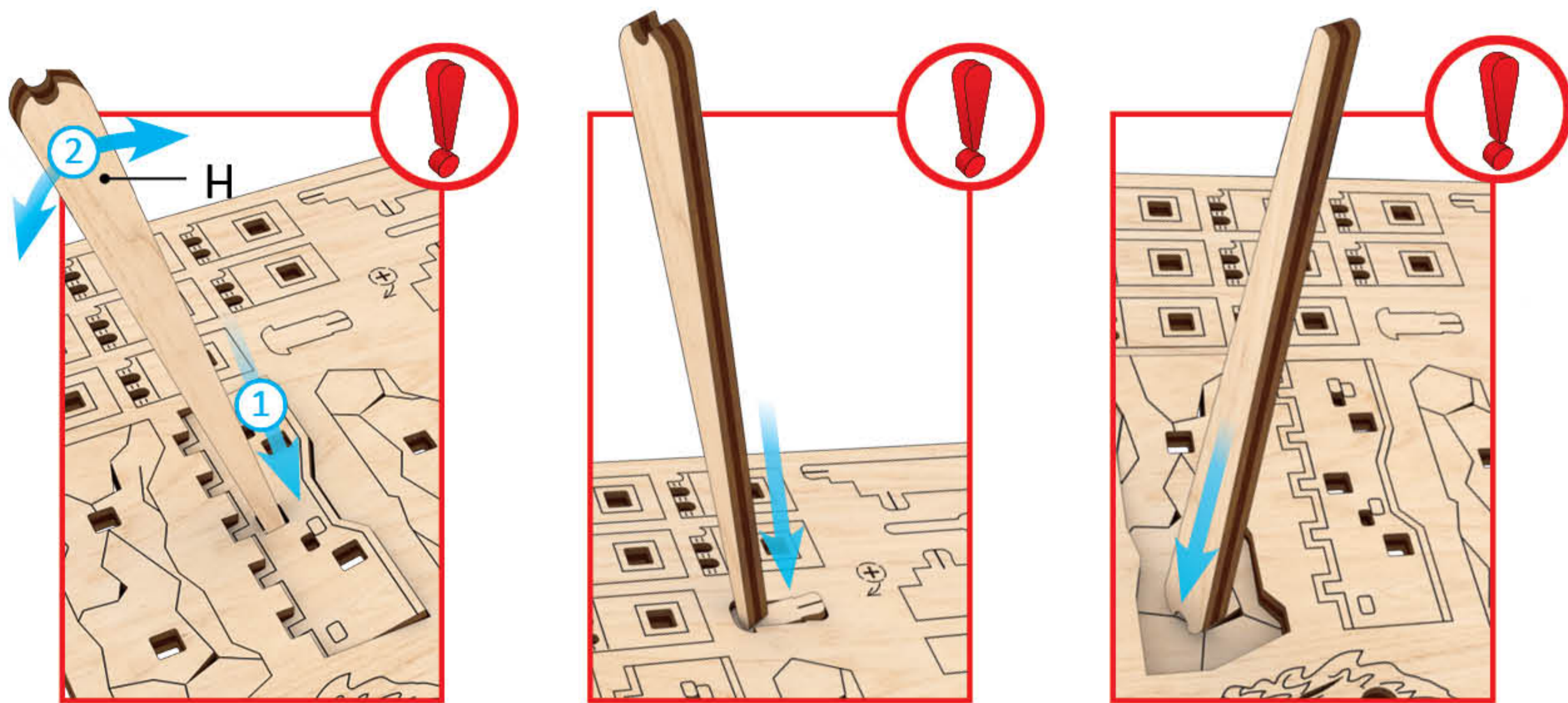

ENG Pay attention. Check position of the part. UKR Зверніть увагу. Перевірте розташування елемента. FRA Faites attention. Vérifiez la disposition de l'élément. DEU Bitte Beachten. Prüfen Sie die Einbaulage des Elementes. SPA Atención. Compruebe la situación del elemento. ITA Prestare attenzione. Controllare la posizione del componente. JPN 方向及び位置に注意して組み立ててください。CHI 注意! 检查部件方向和位置。POR Preste atenção à posição da peça. POL Zwróć uwagę. Sprawdź lokalizację elementu. KOR 방향 또는 위치에 주의해서 조립해 주세요.

ENG Wax the part with a regular candle (rub with a candle). UKR Змастіть деталь звичайною свічкою (потріть об свічку). FRA Lubrifiez la pièce avec une bougie ordinaire (frottez contre la bougie). DEU Reiben Sie das Teil mit einer einfachen Kerze etwas ein. SPA Engrase la pieza con una vela común (frote con una vela). ITA Incerare il componente (Sfregare con la cera). JPN された部分に潤滑剤としてロウソクを塗ってください。CHI 用普通蜡烛涂抹润滑部件。POR Encere a peça com uma vela comum (esfregue em uma vela). POL Przesmaruj zwykłą świecą. KOR 표시된 부분에 윤활을 위해 초를 칠해 주세요.

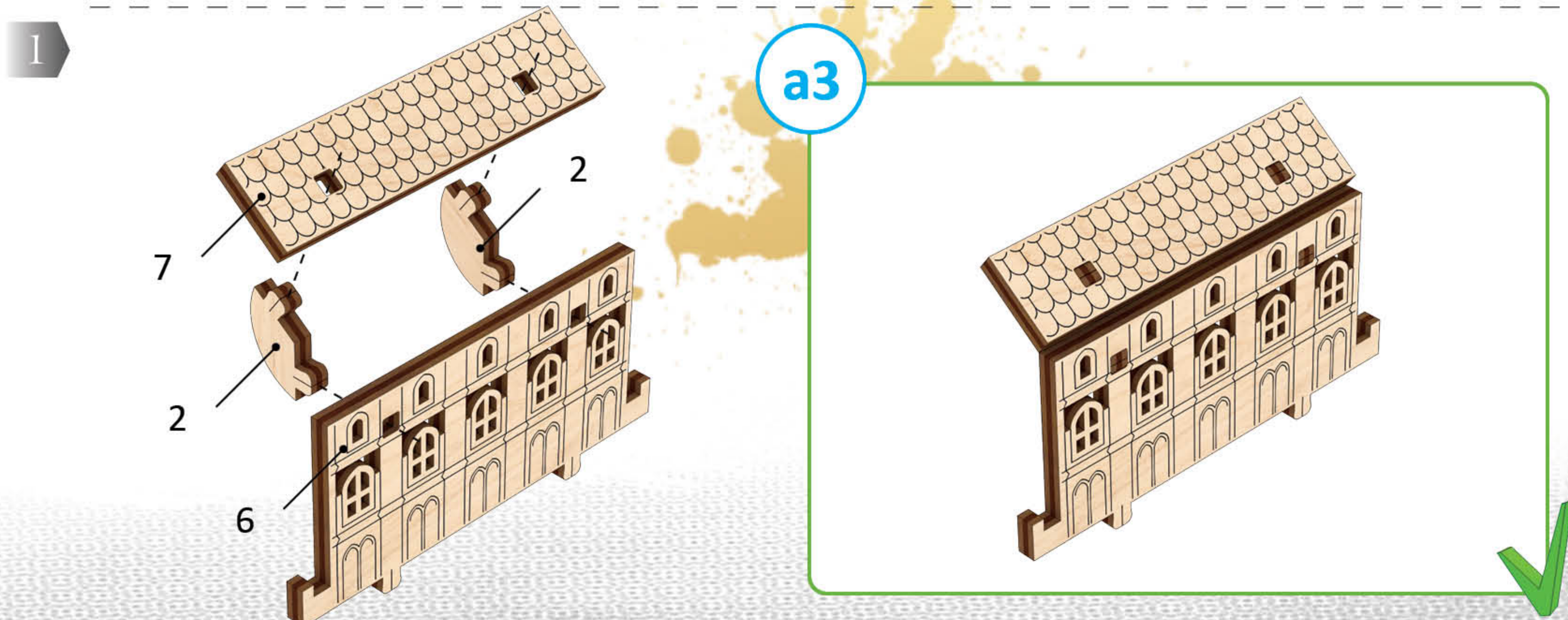
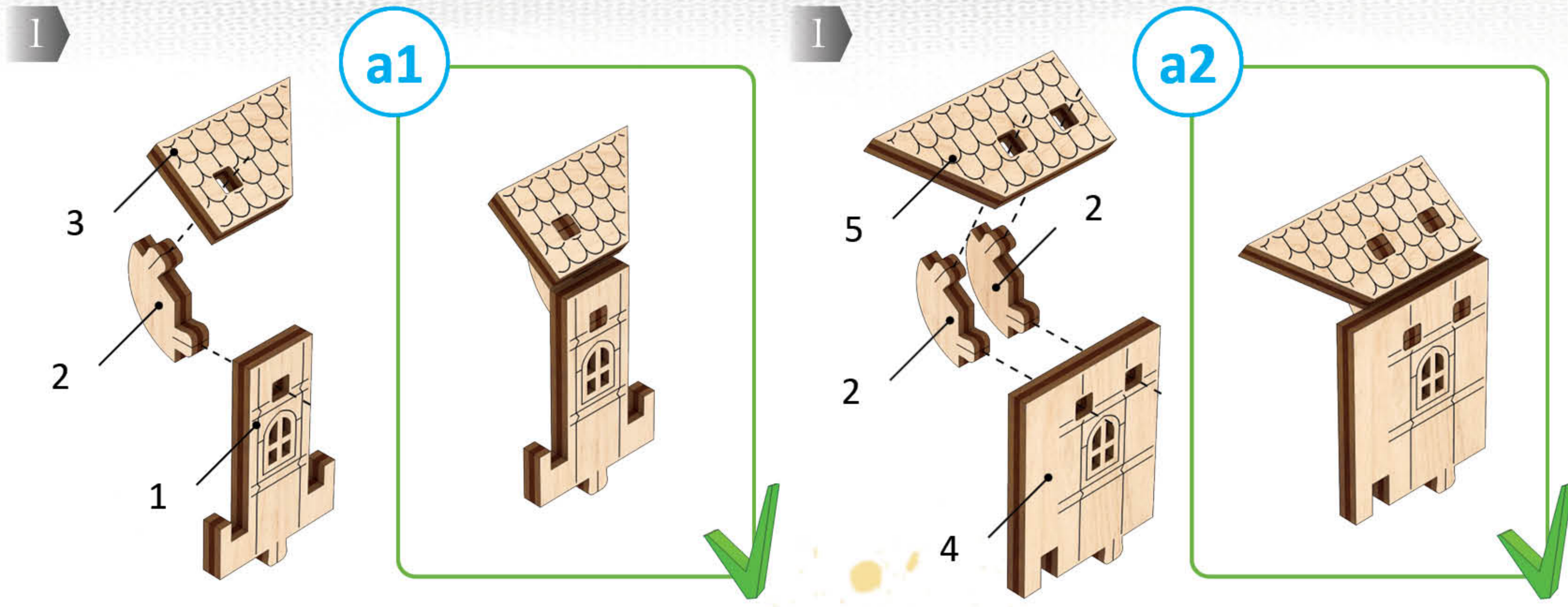

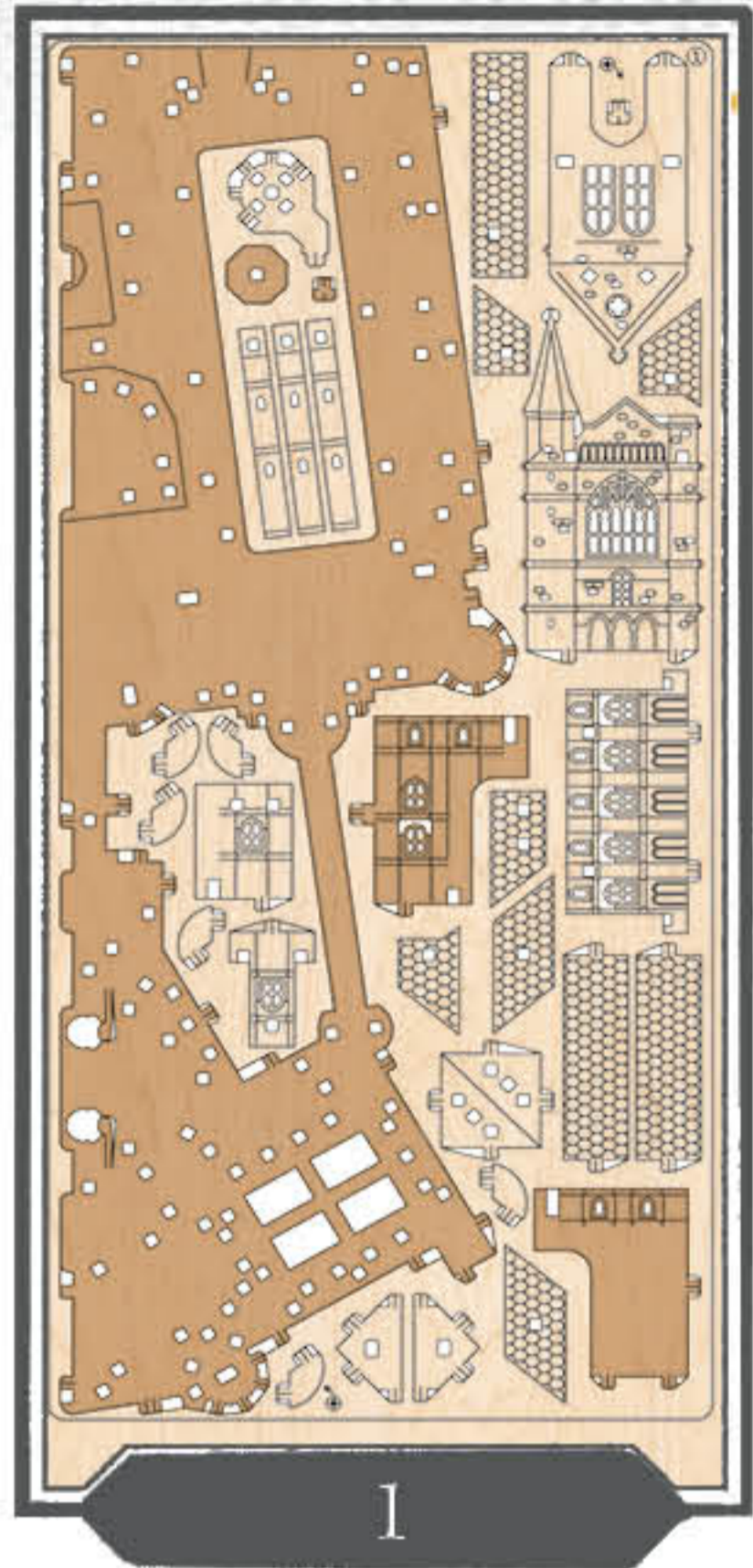

1

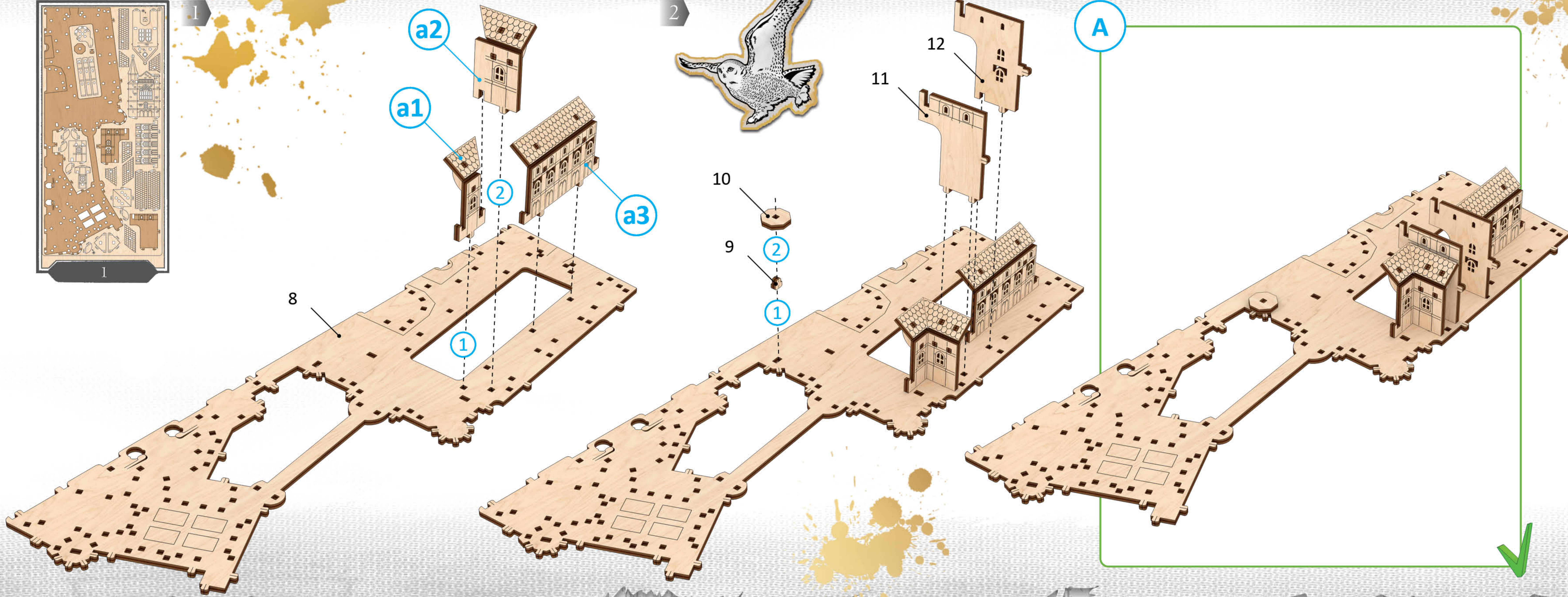

2



10

9

2

1

11

12

A

5

NOW-VA



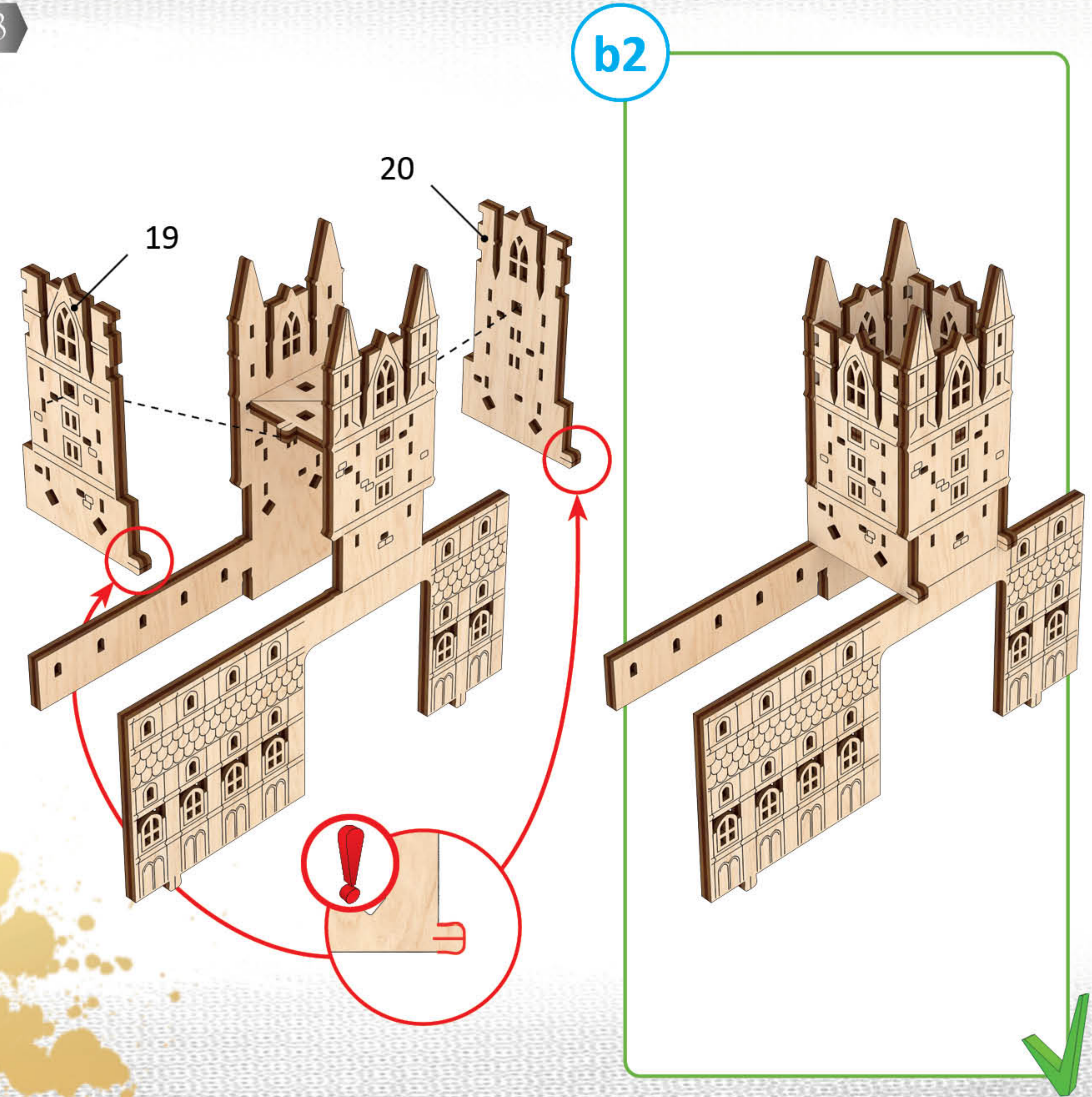
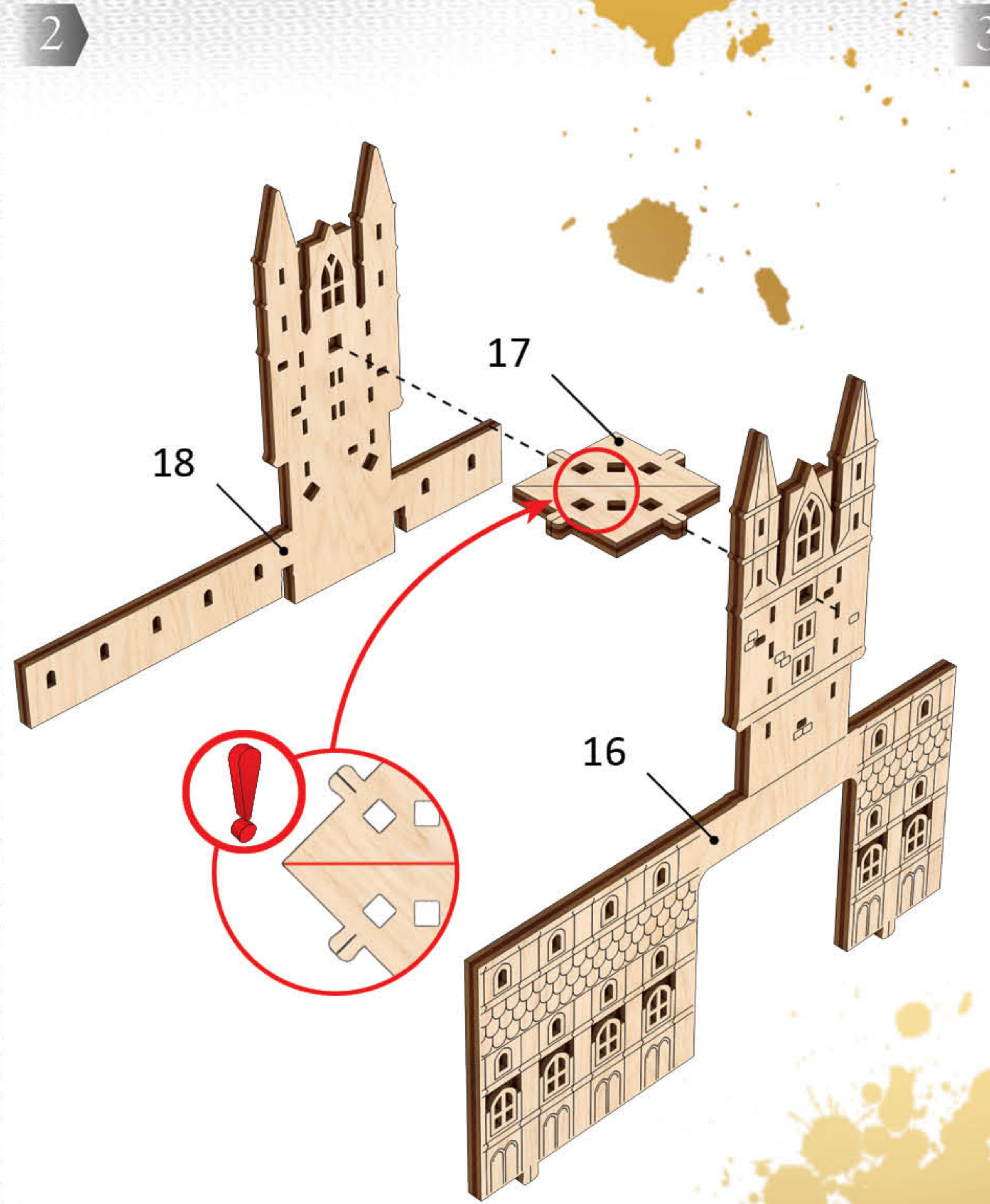
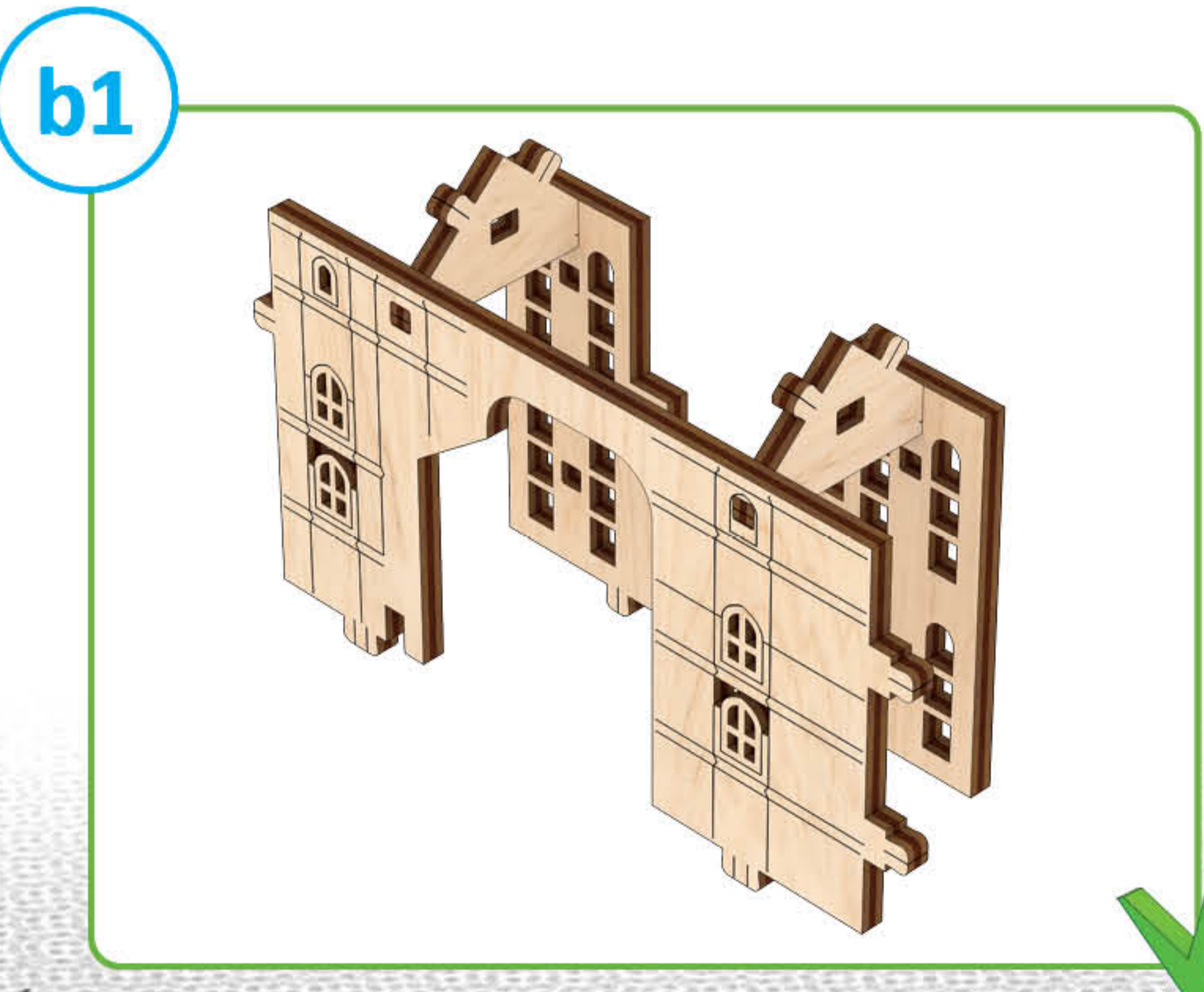
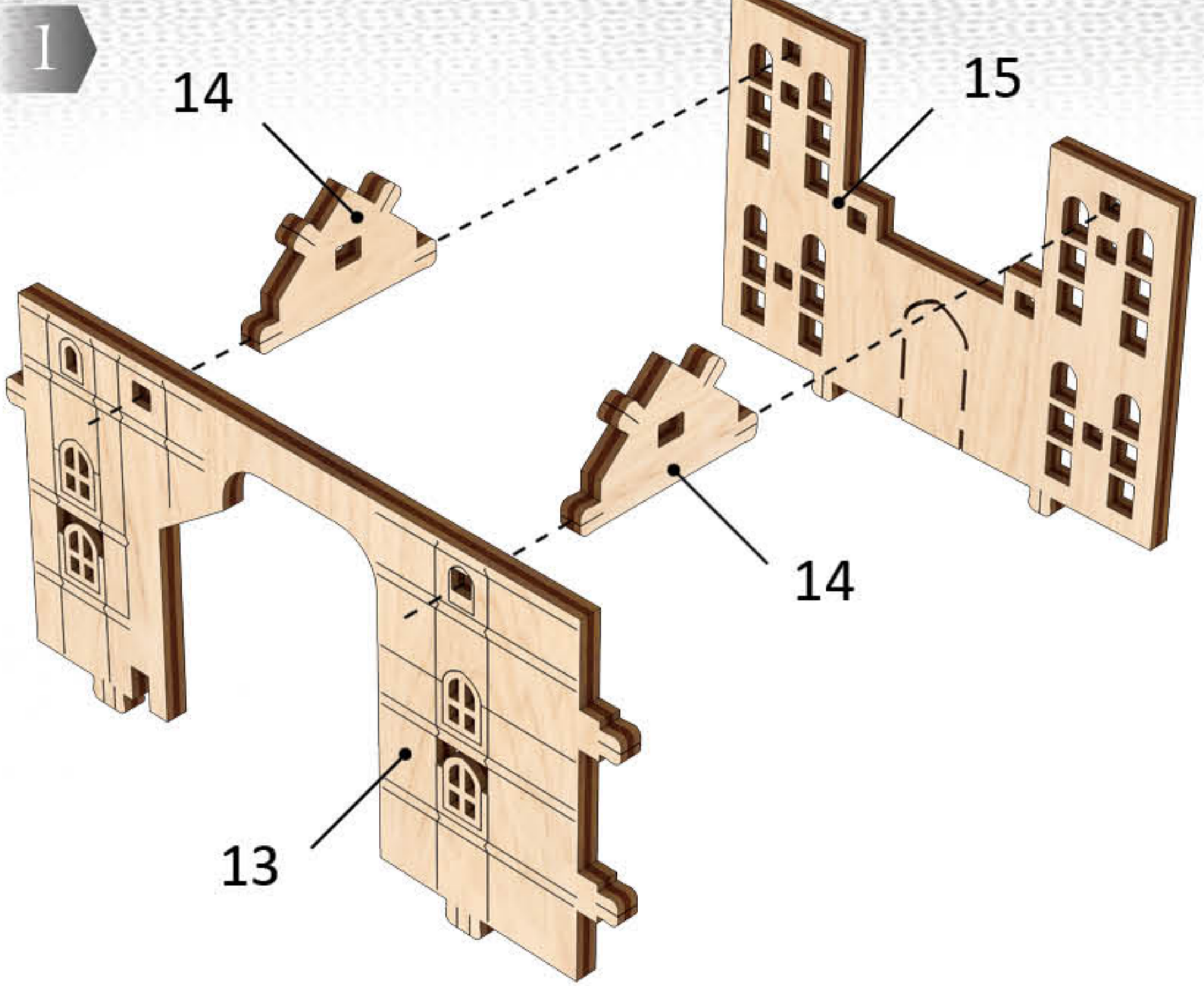
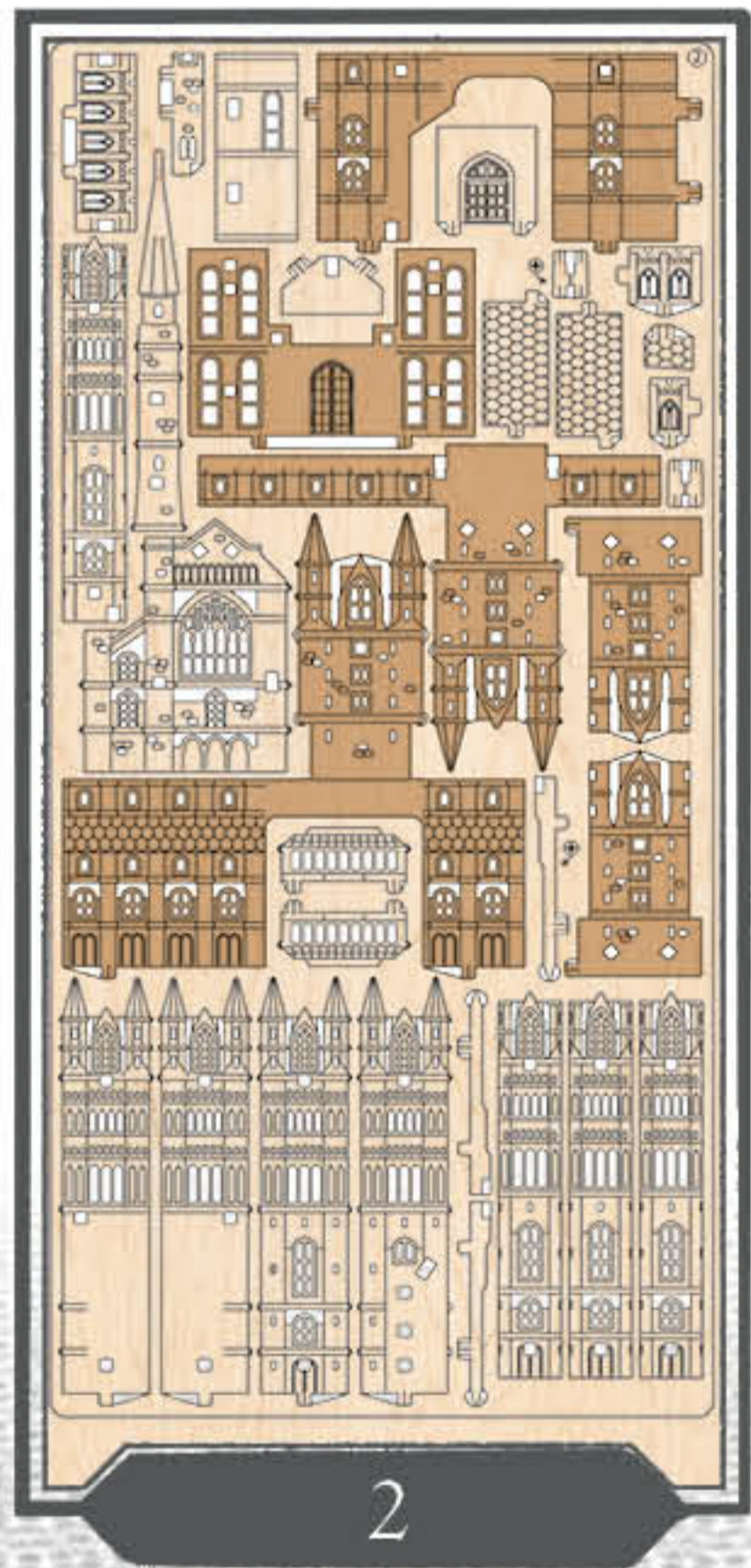
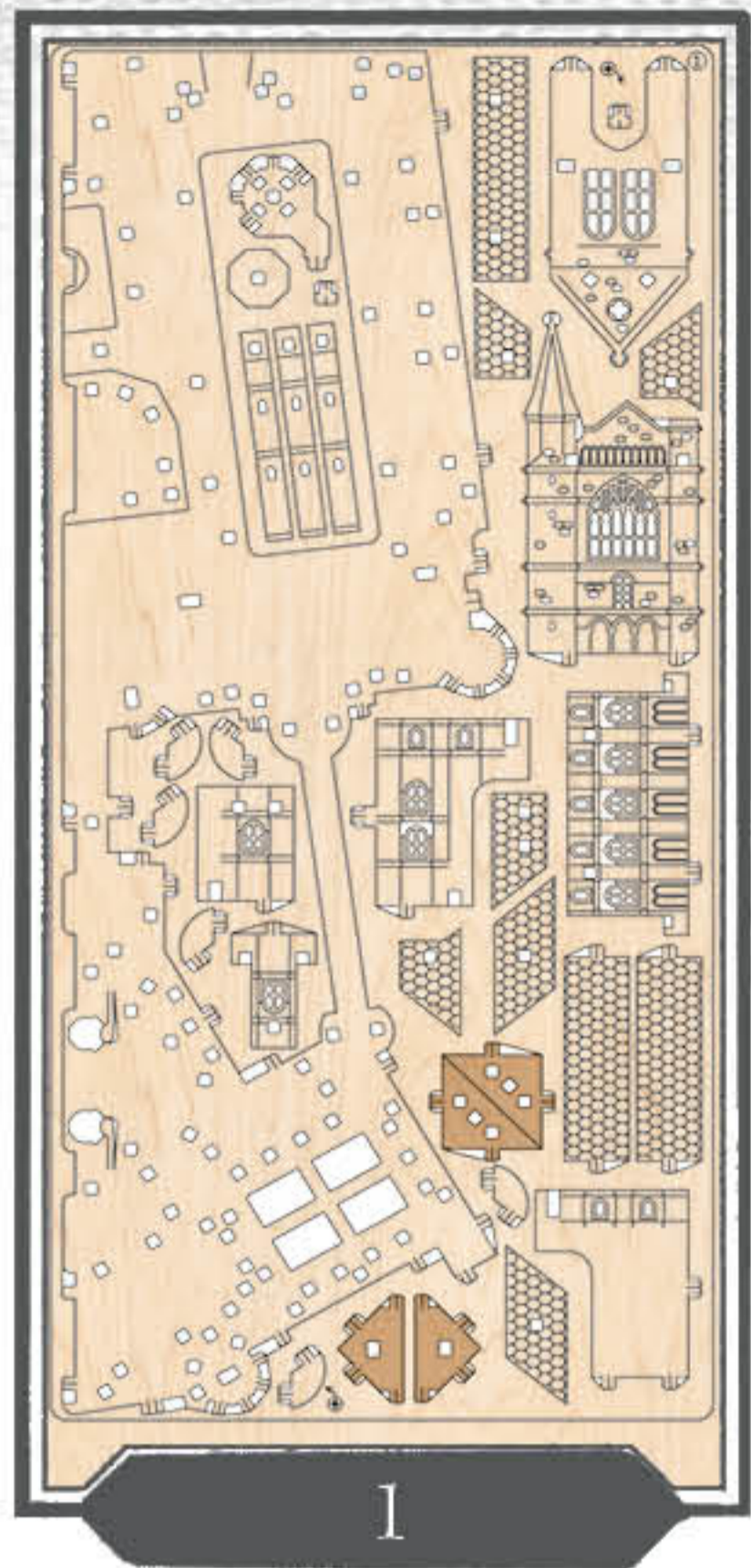

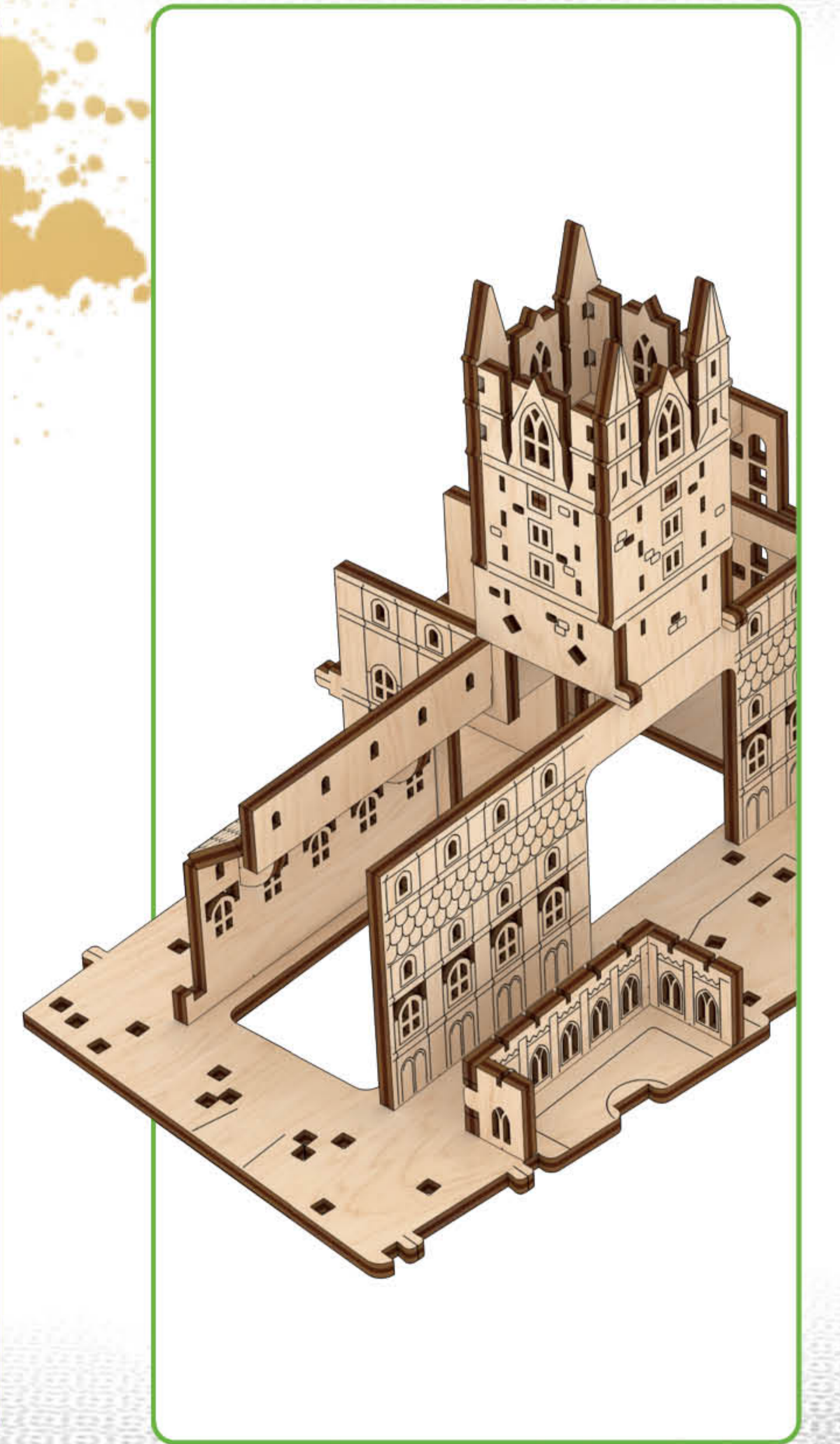
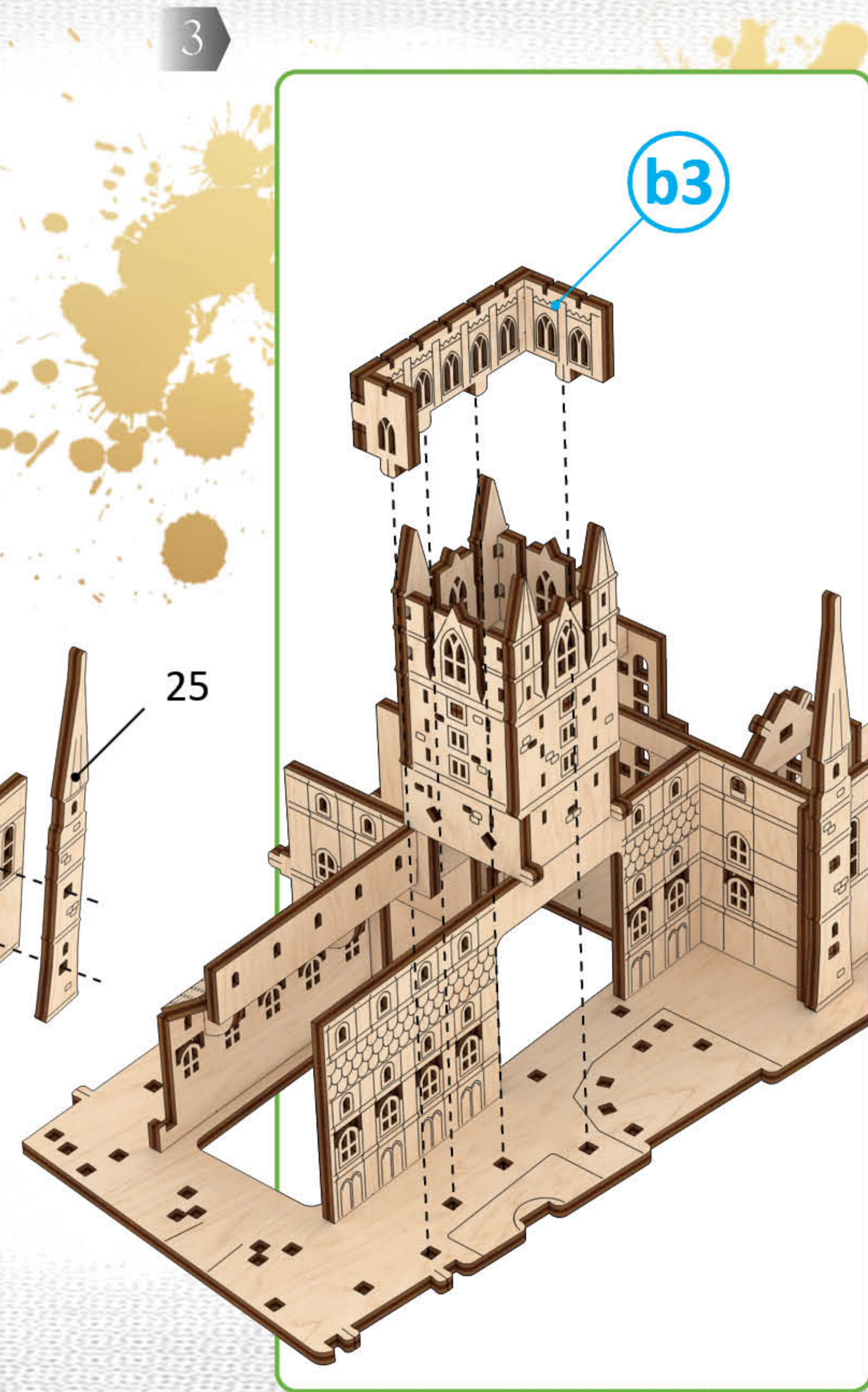
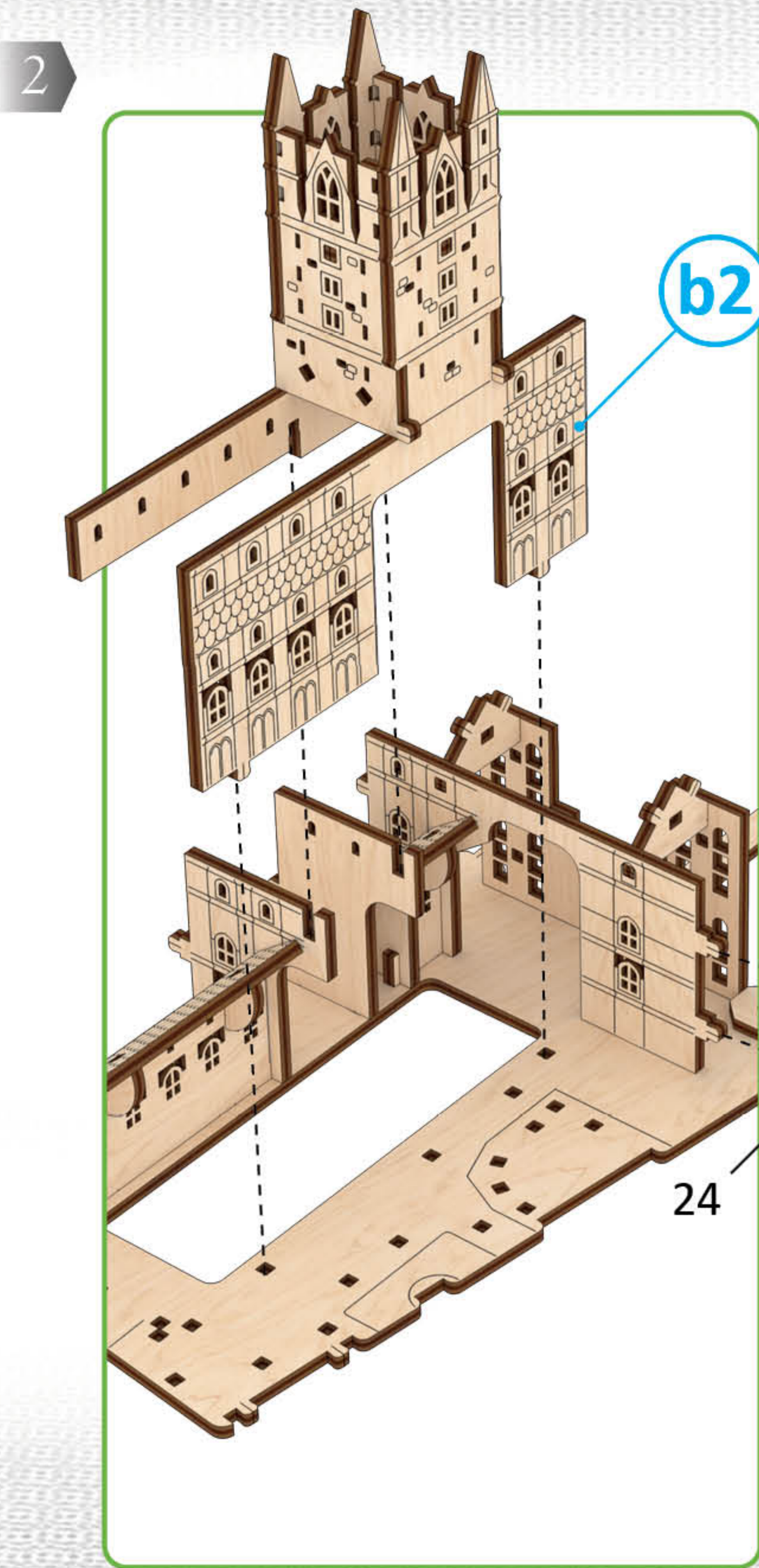
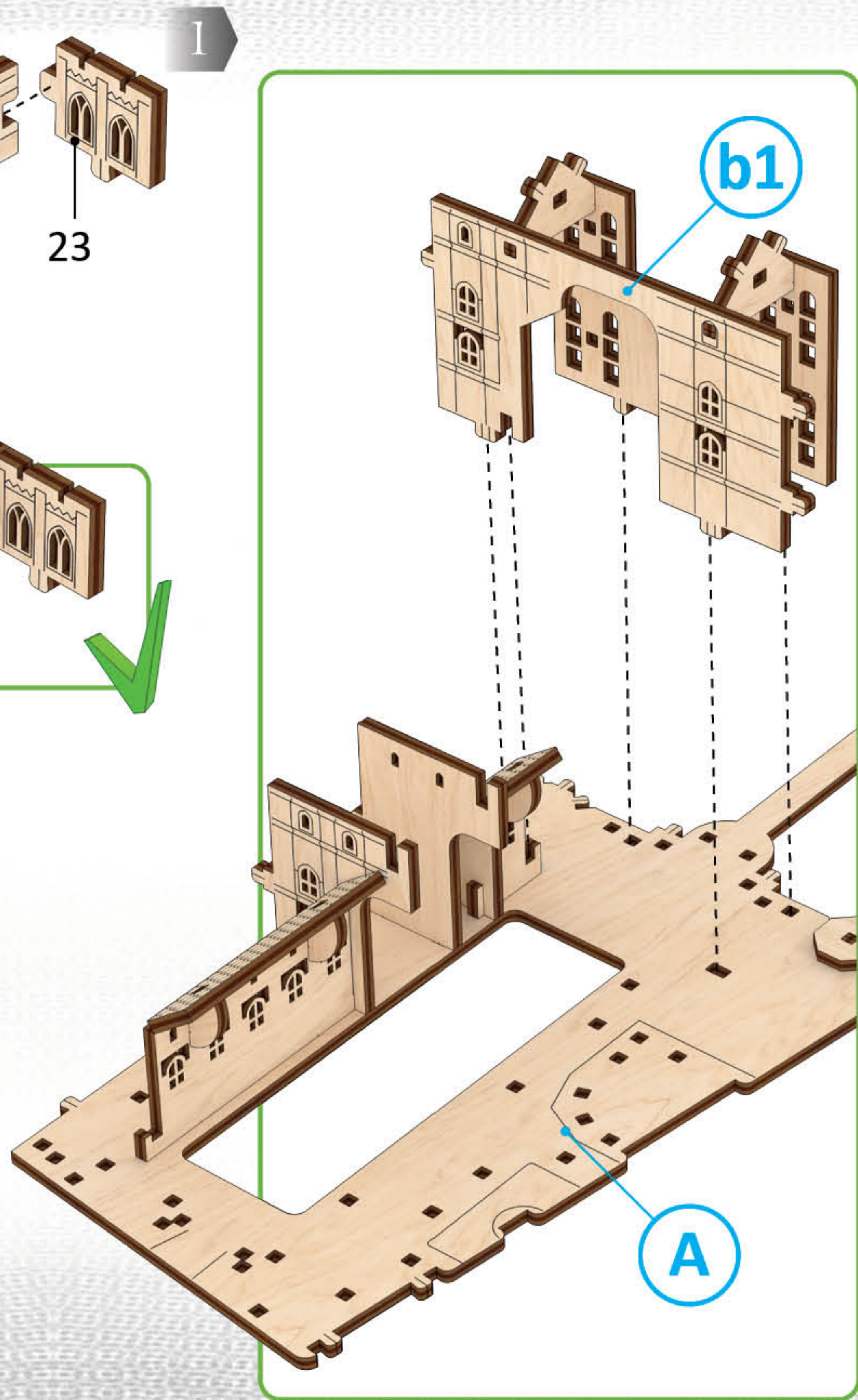
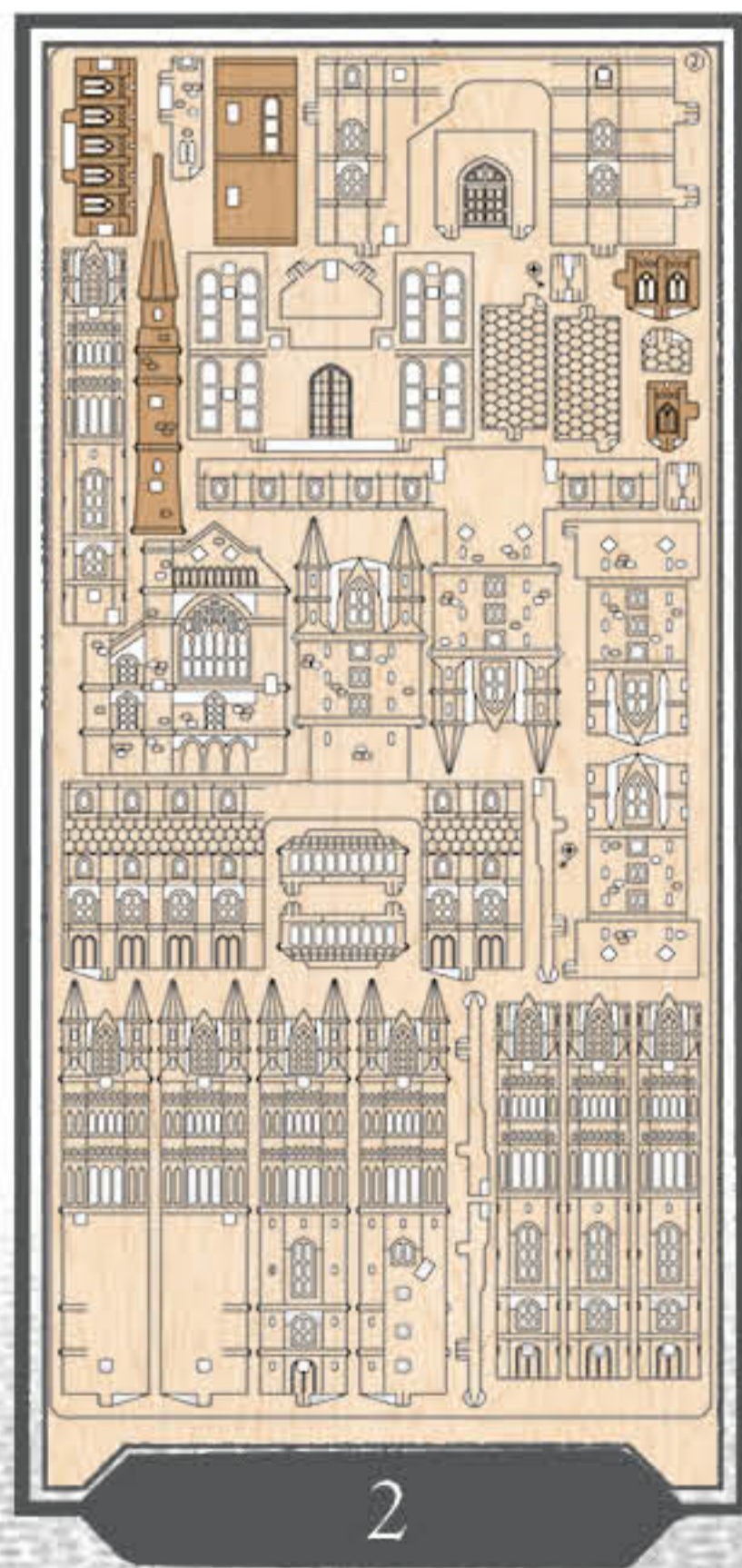
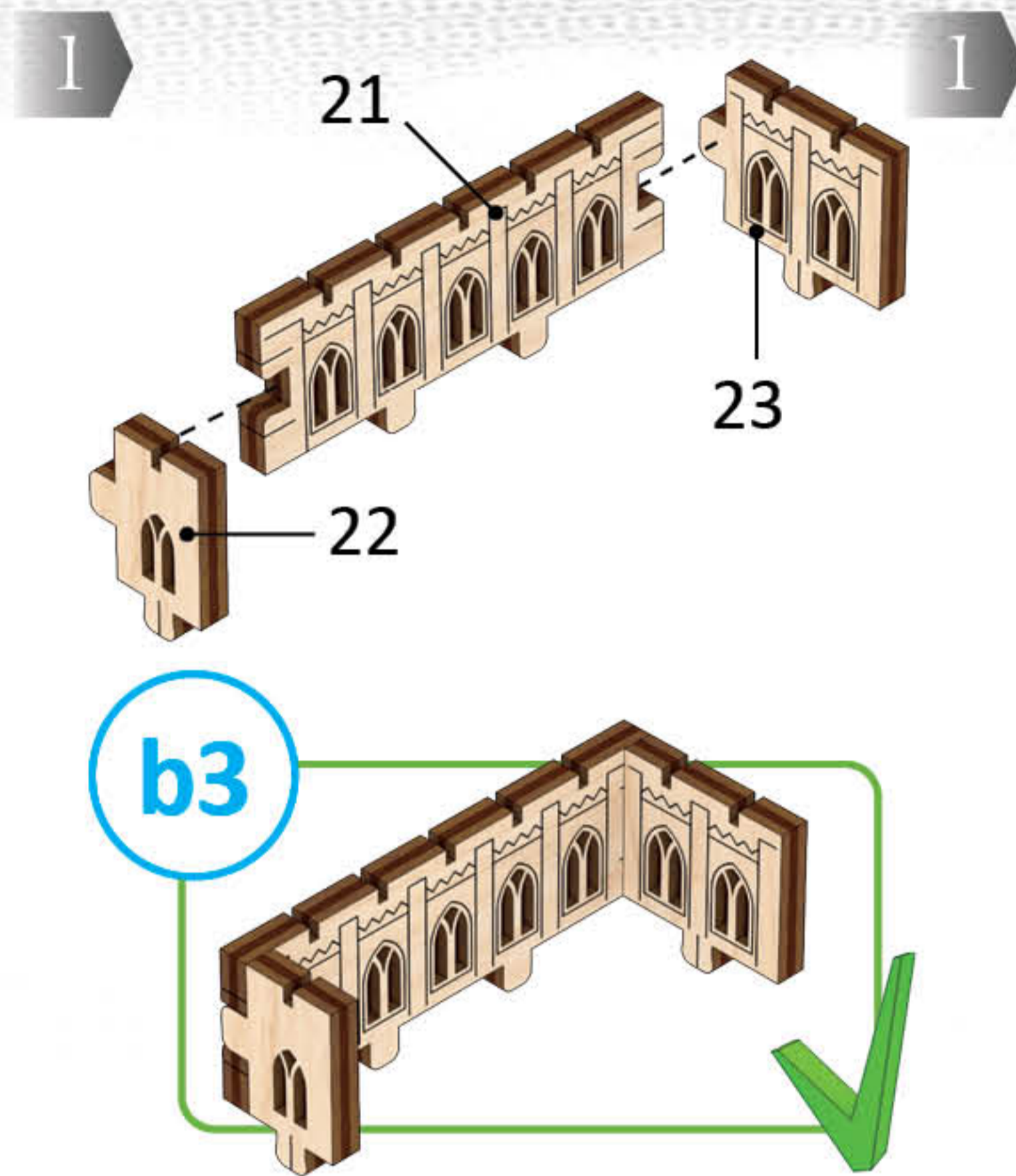

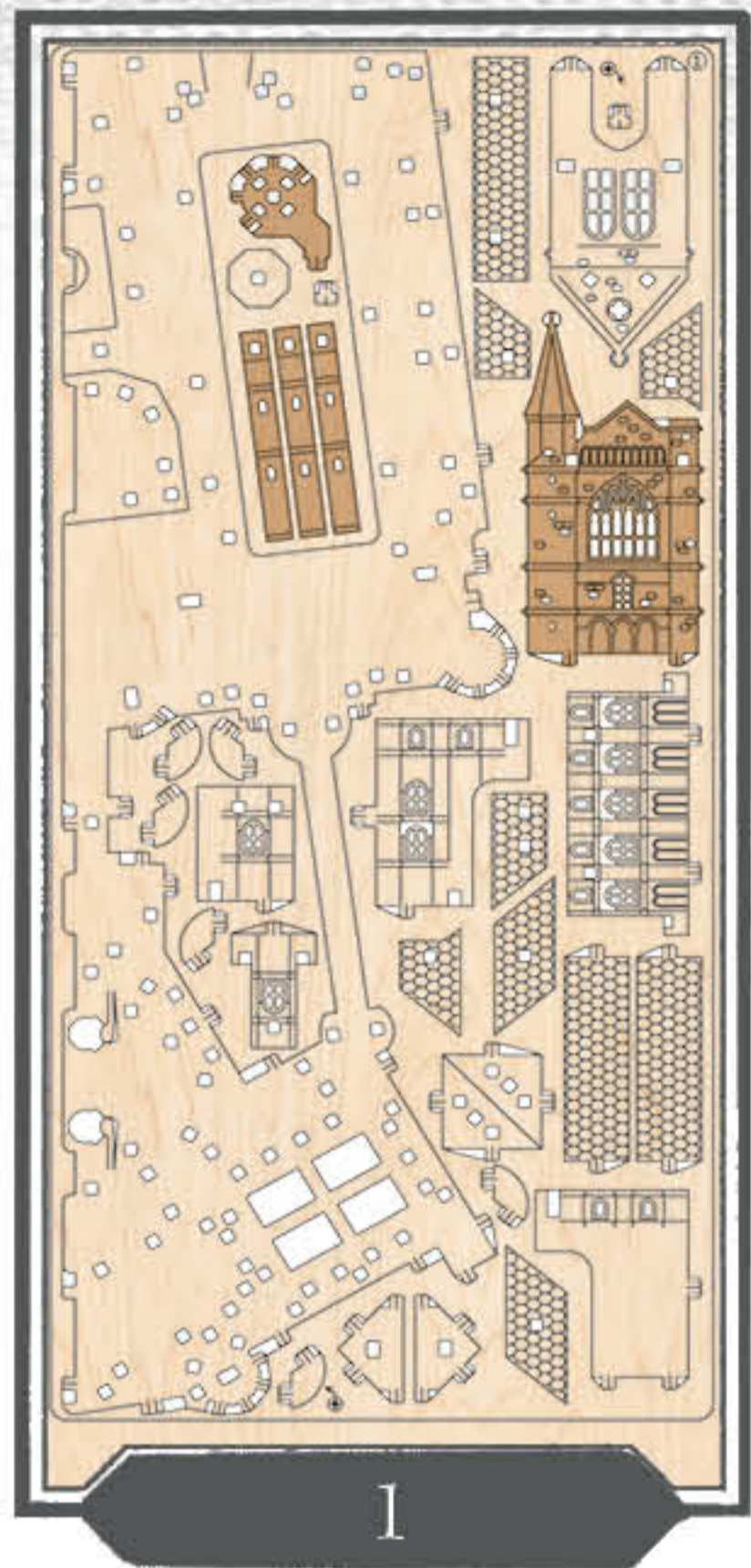

4

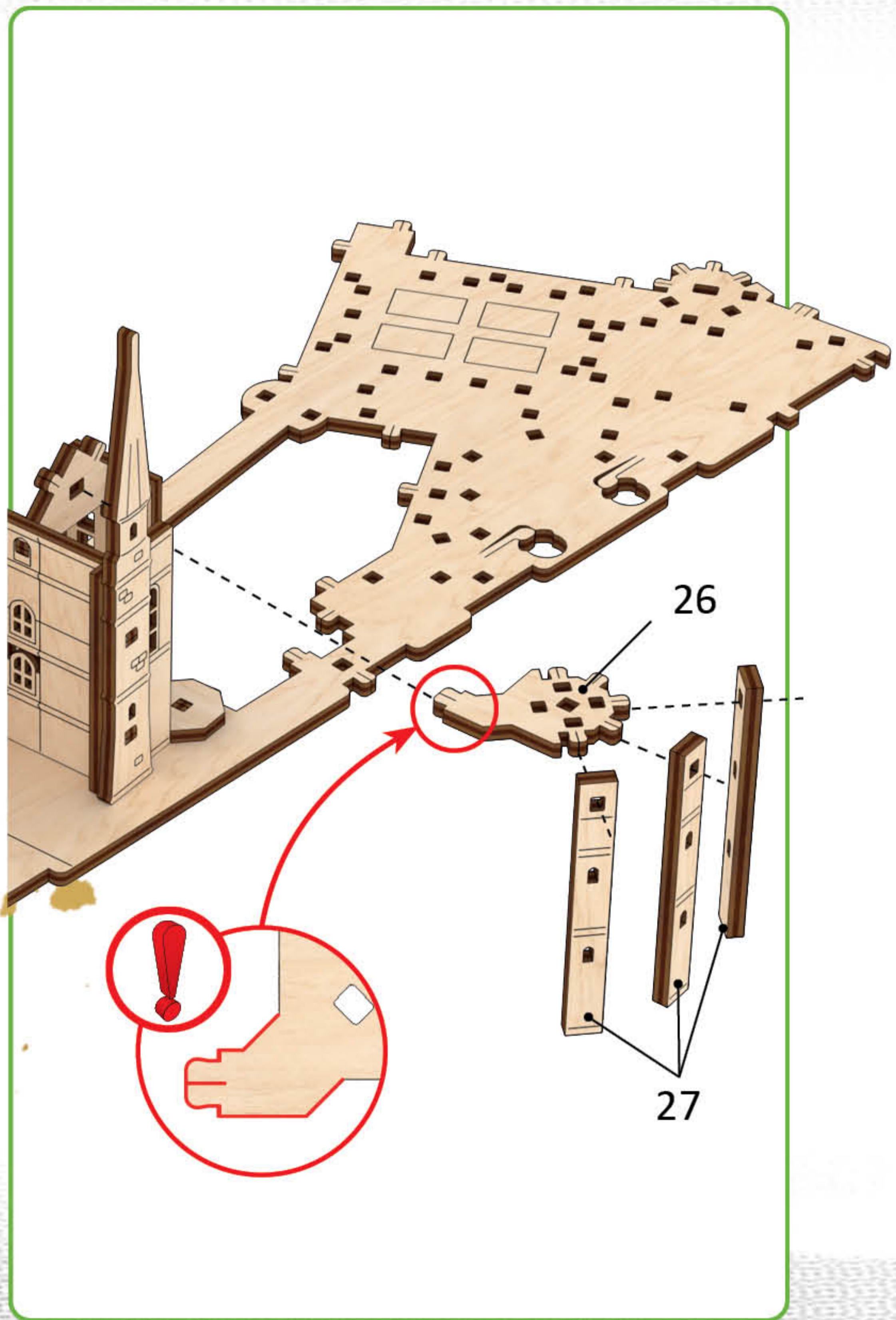

5

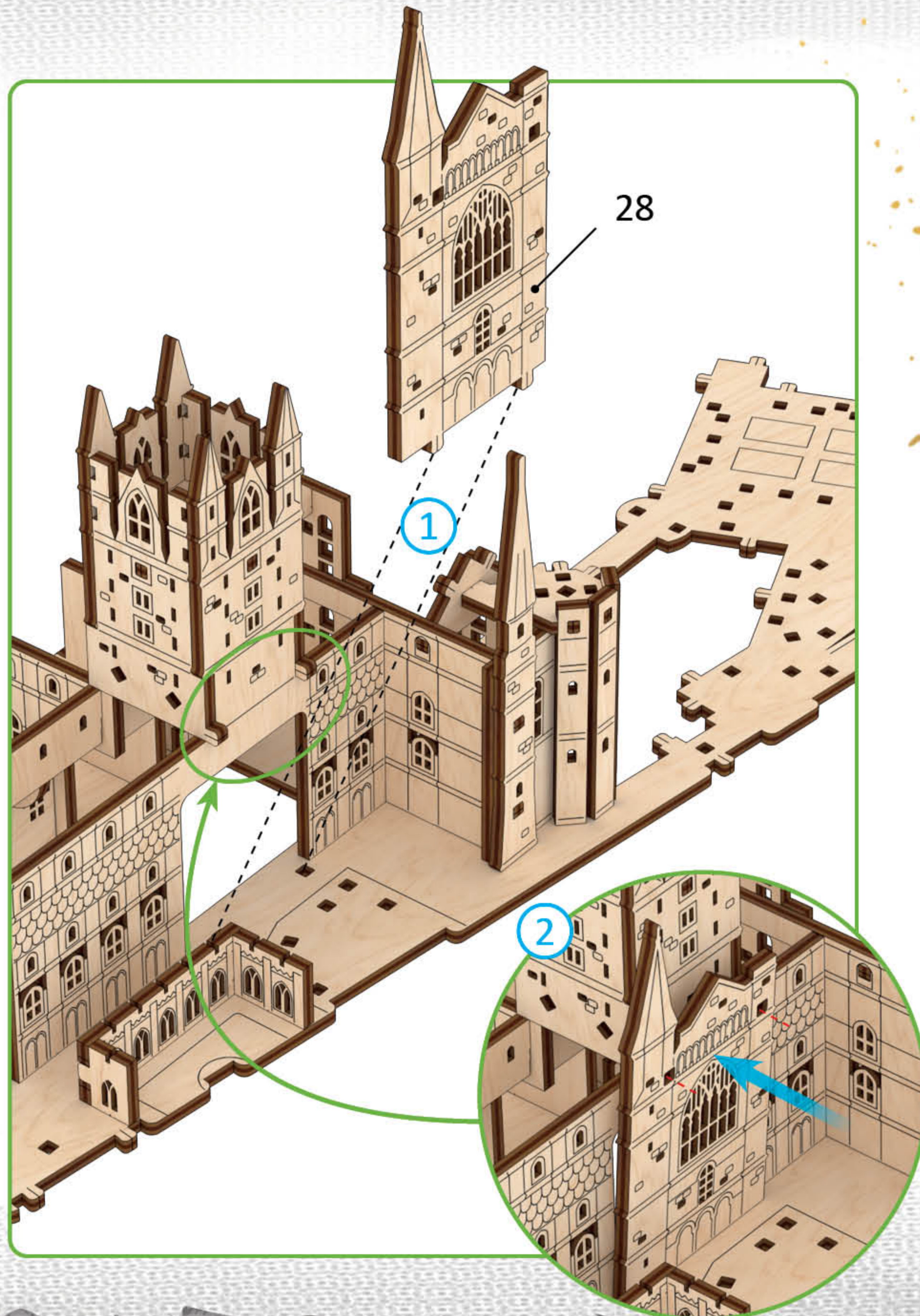

B



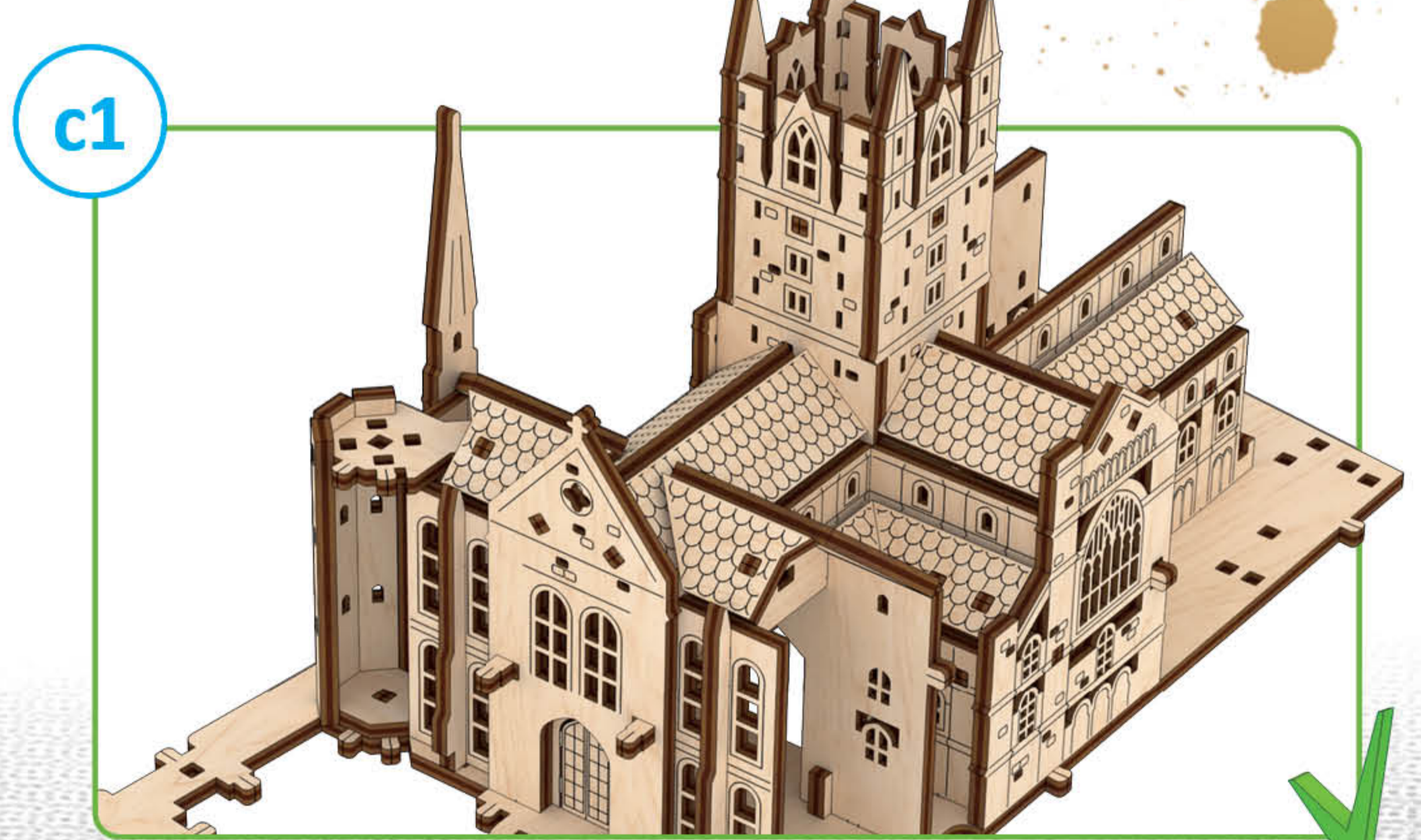
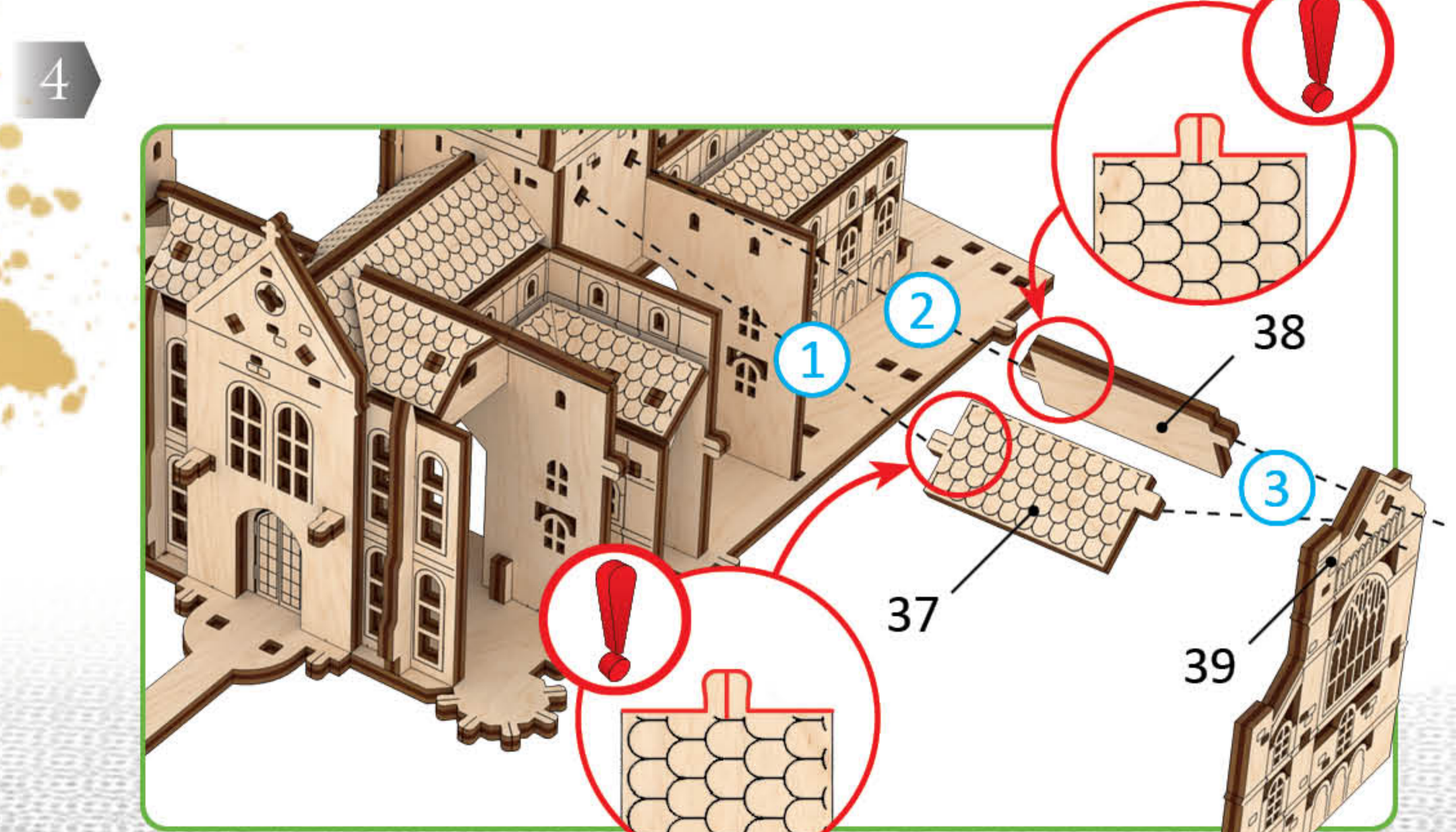
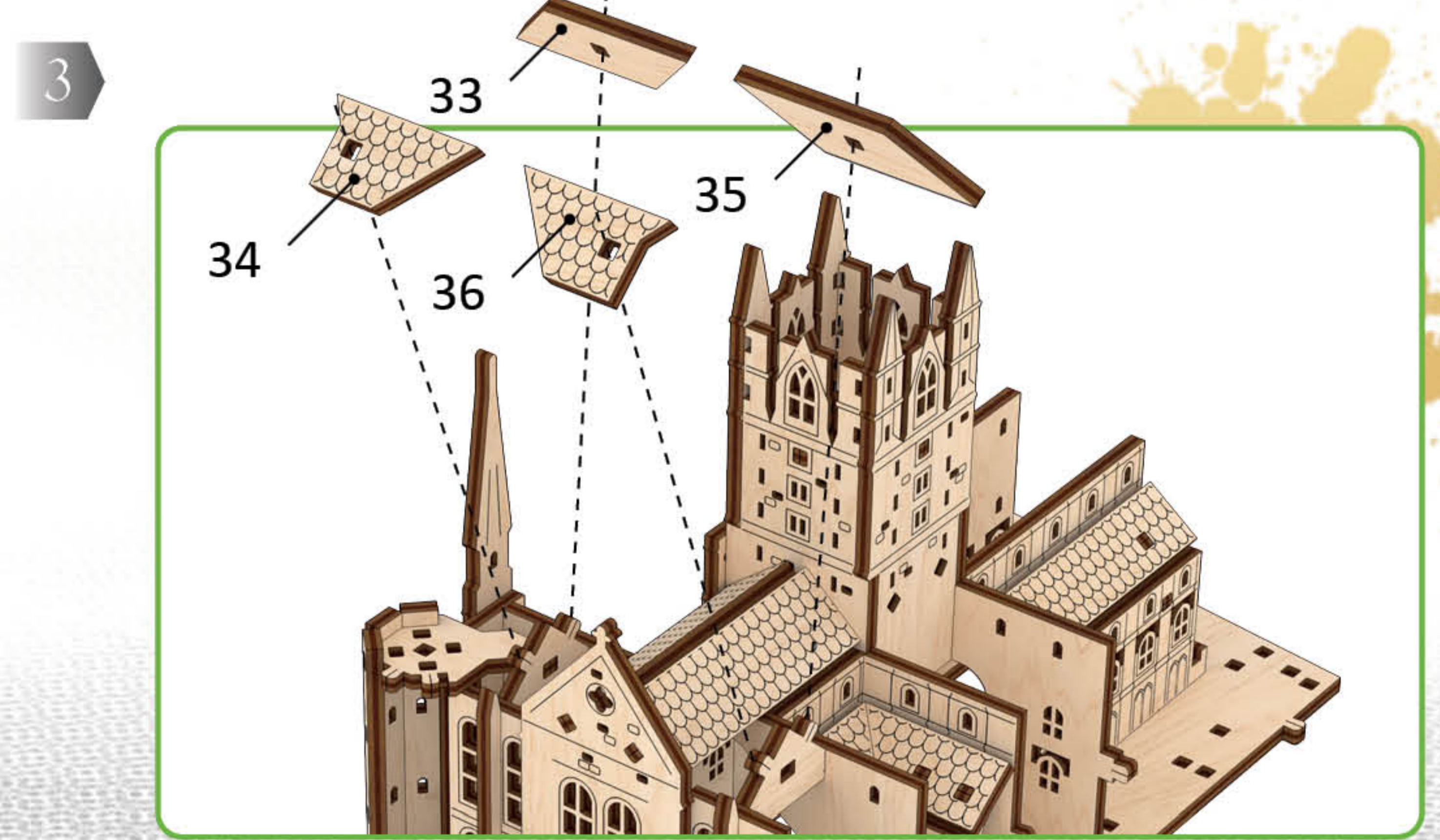
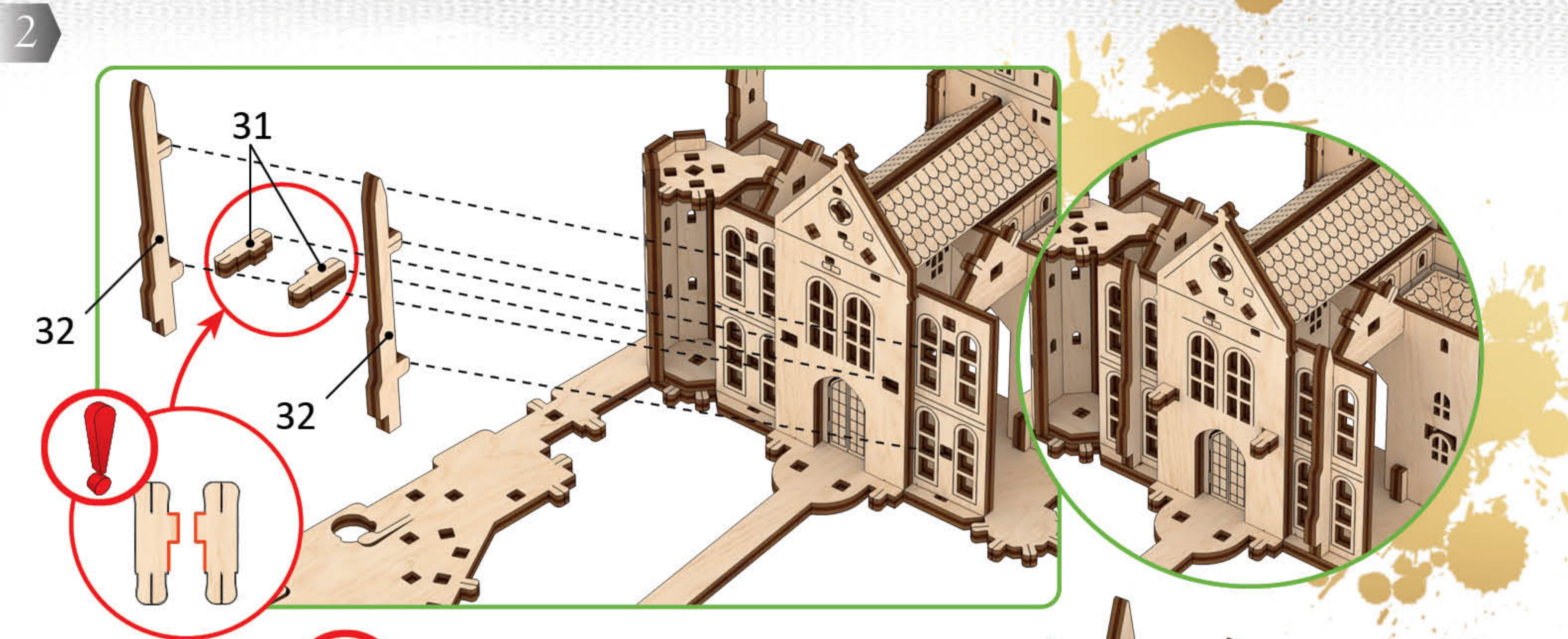
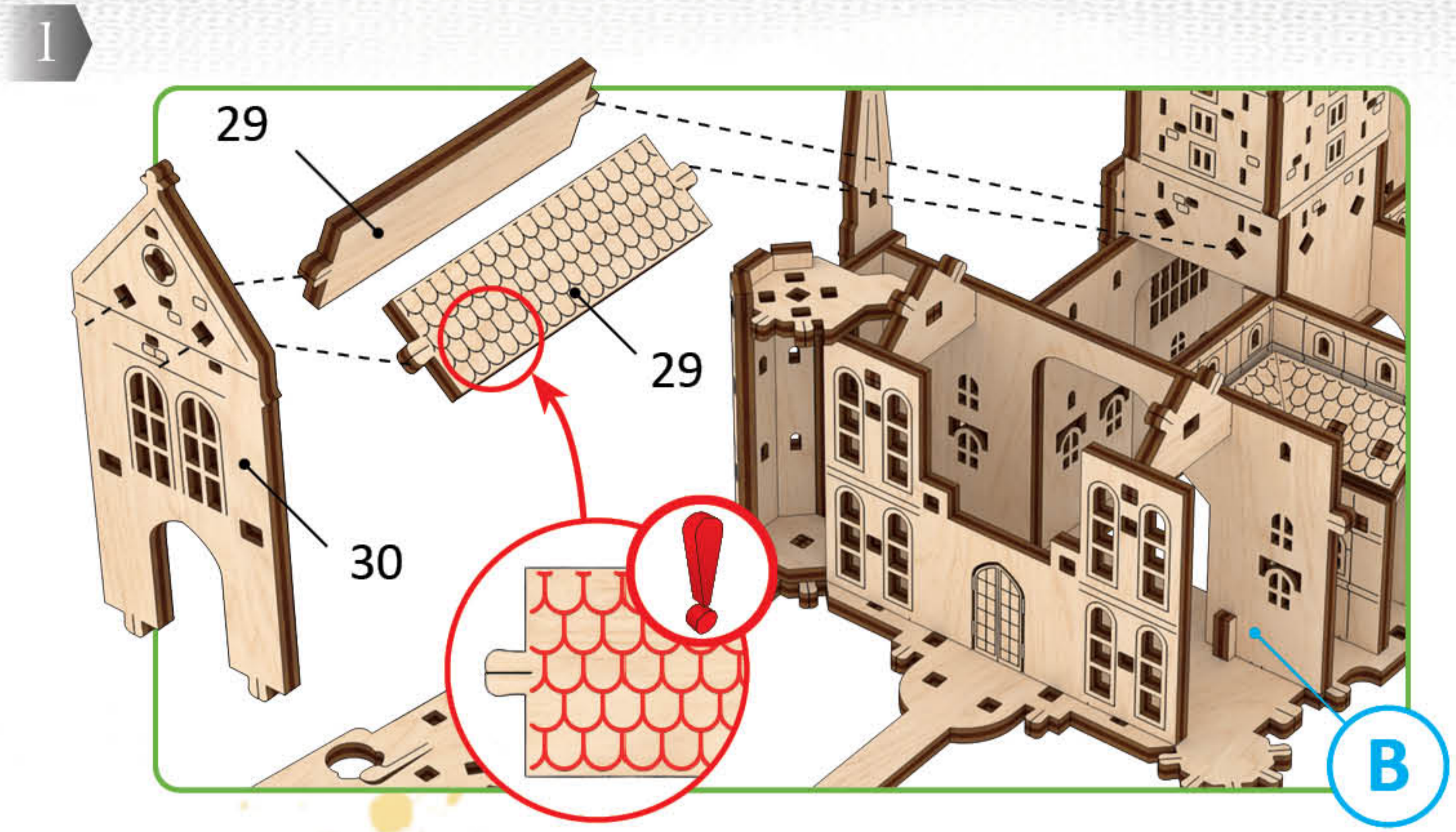
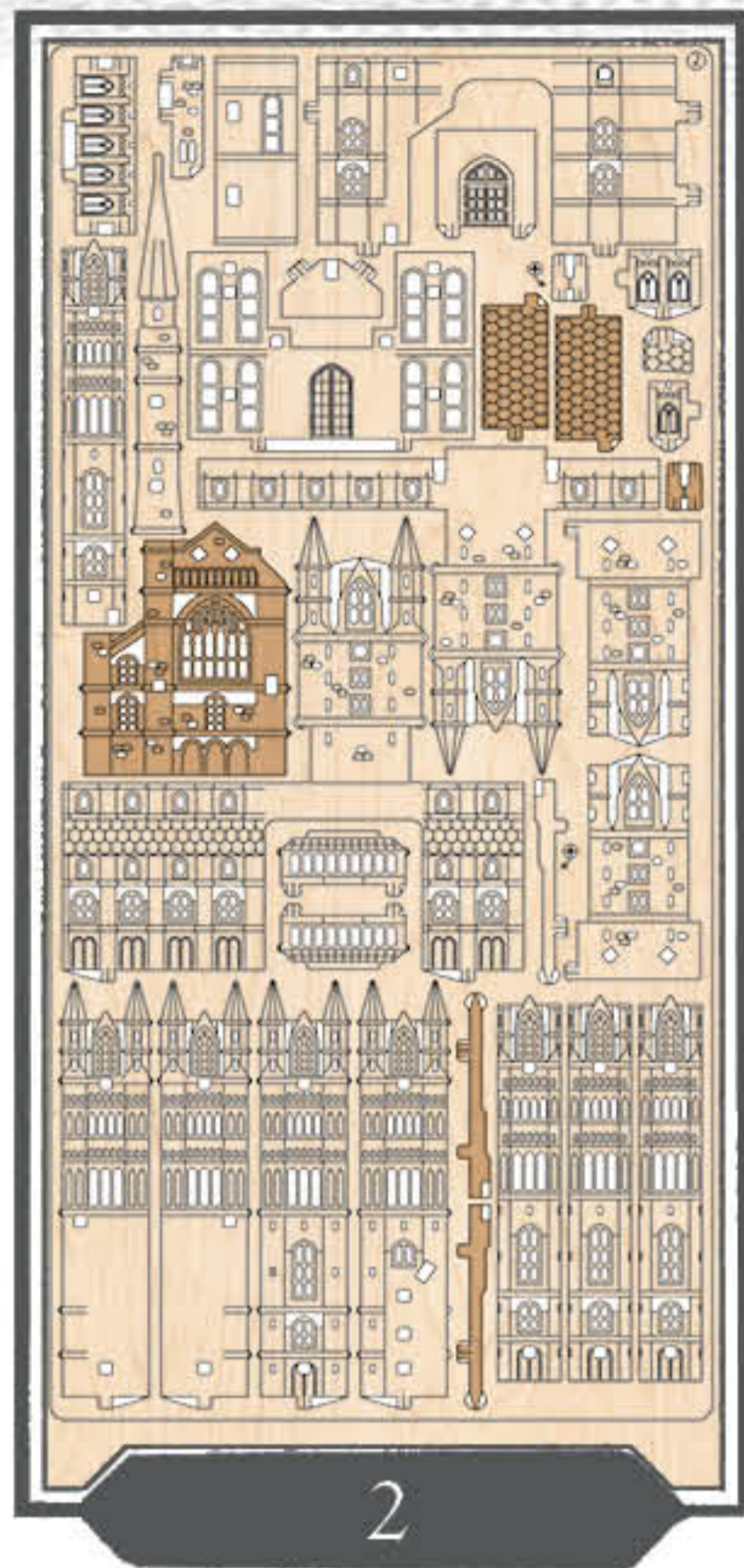
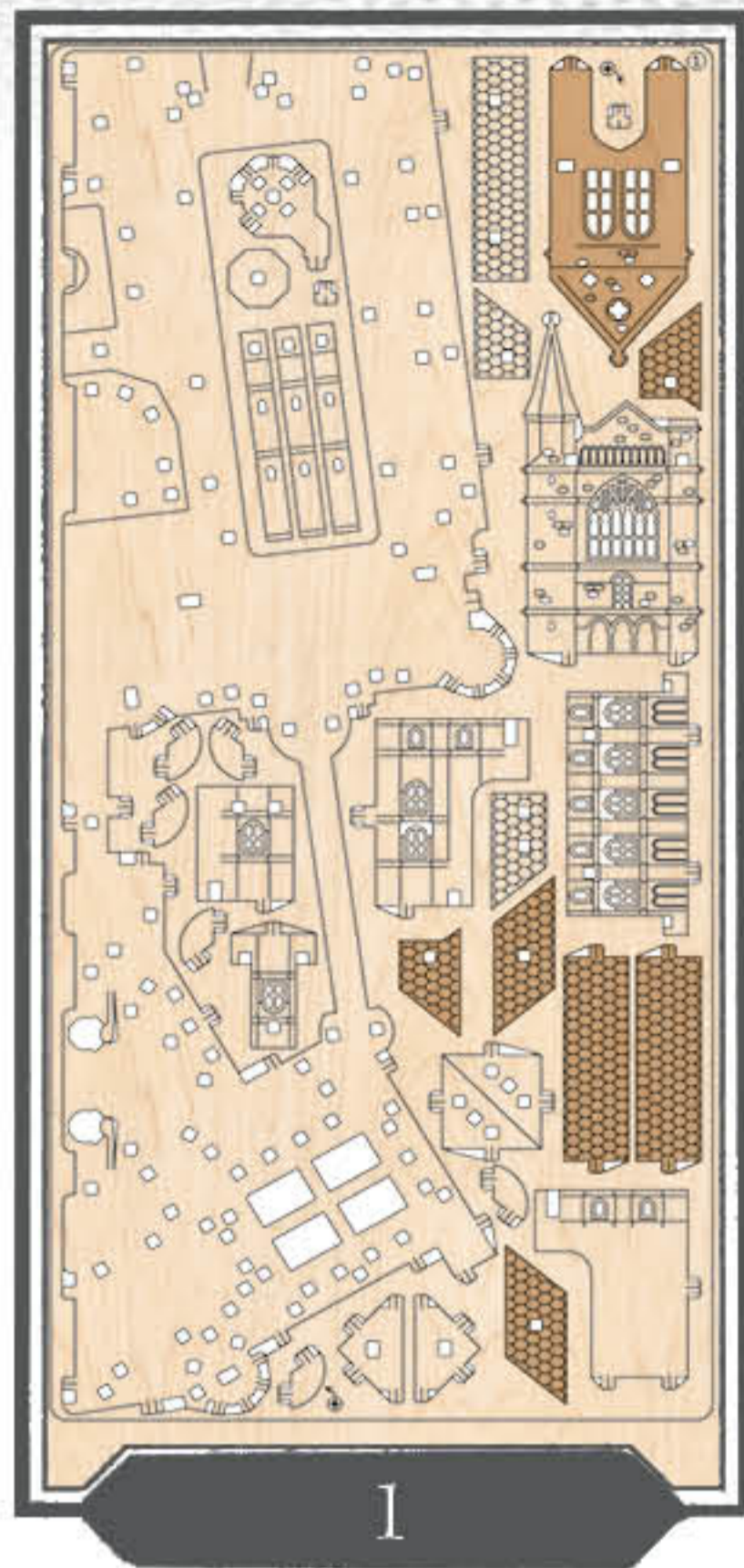

1

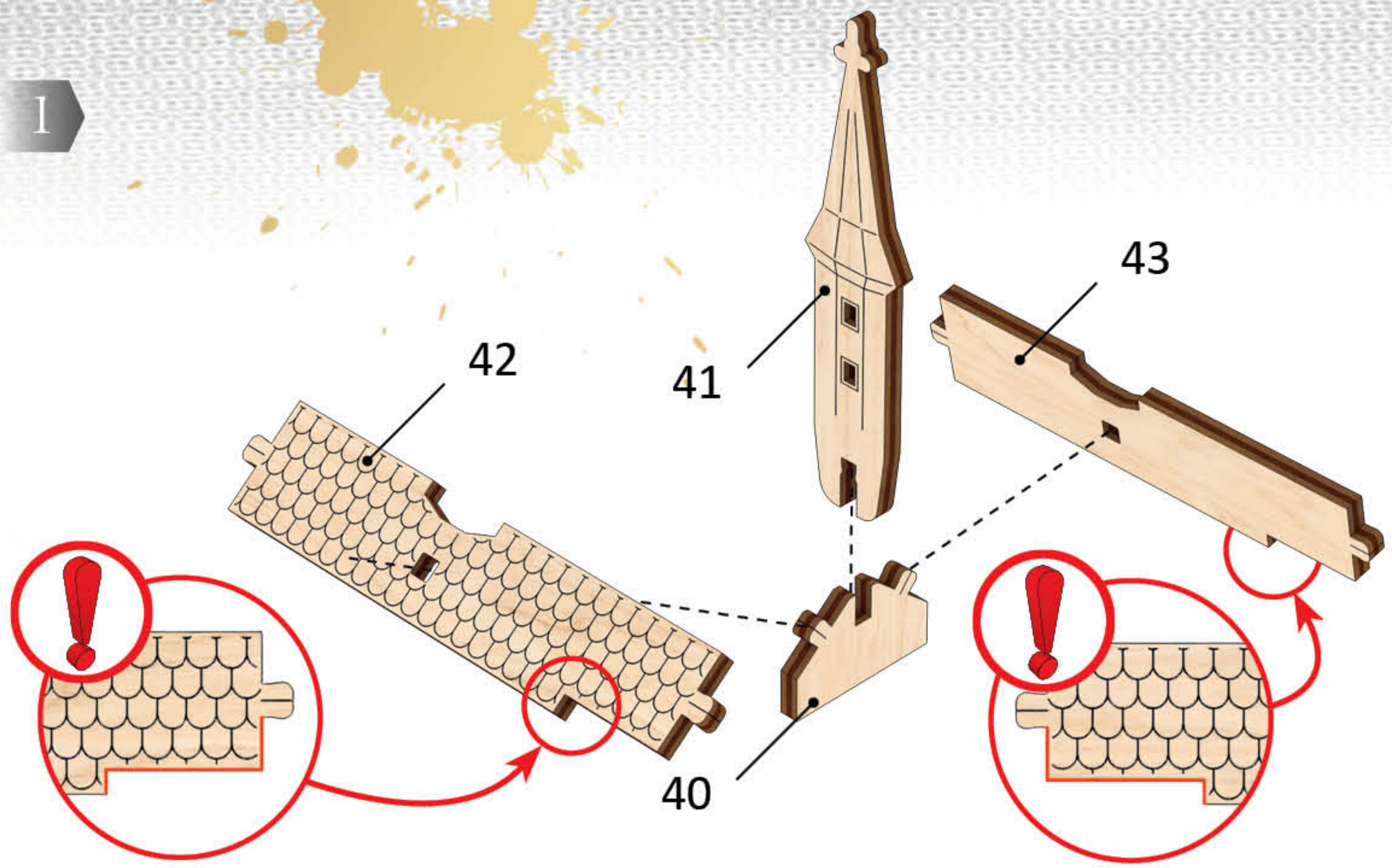

c2

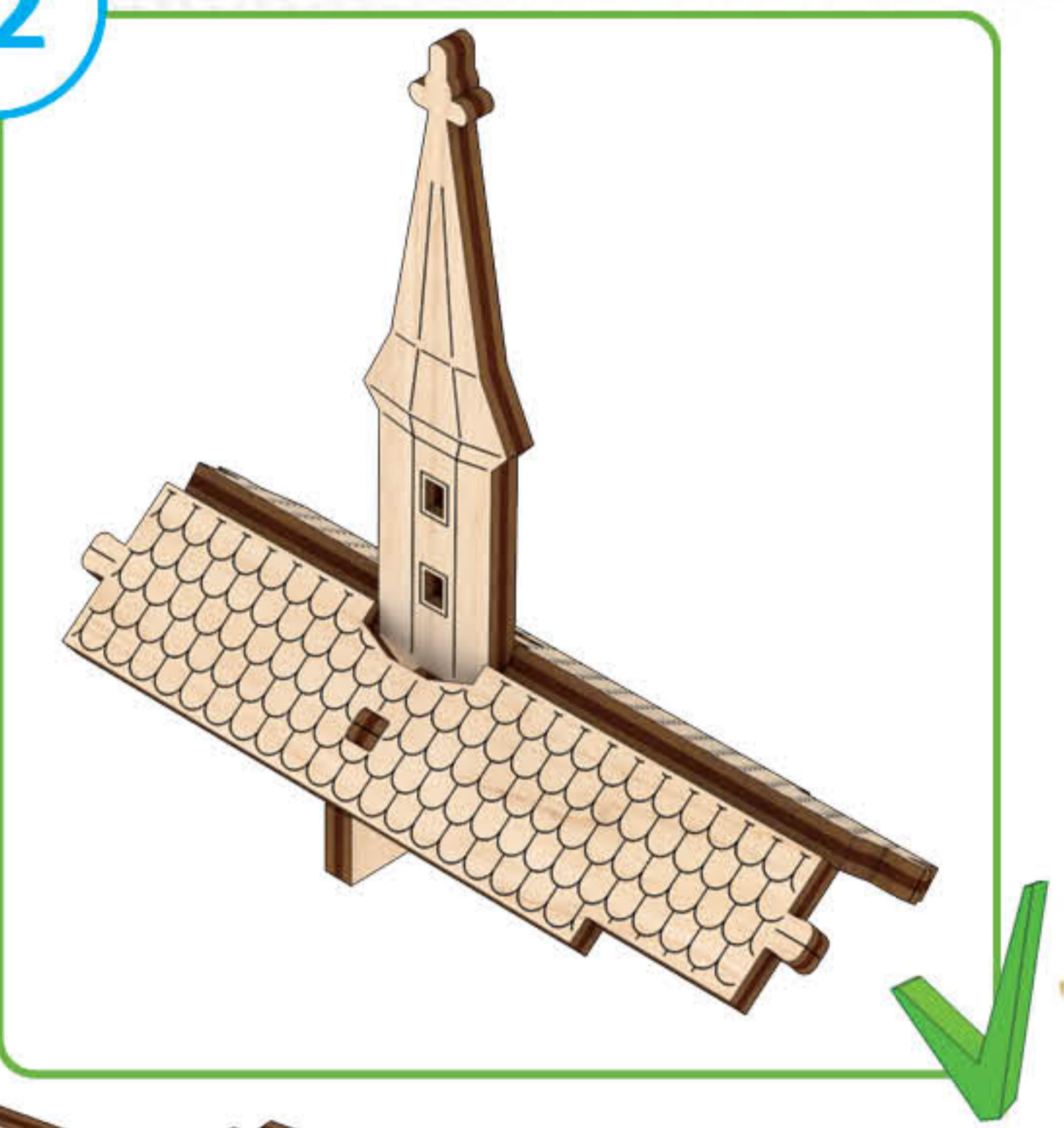

1

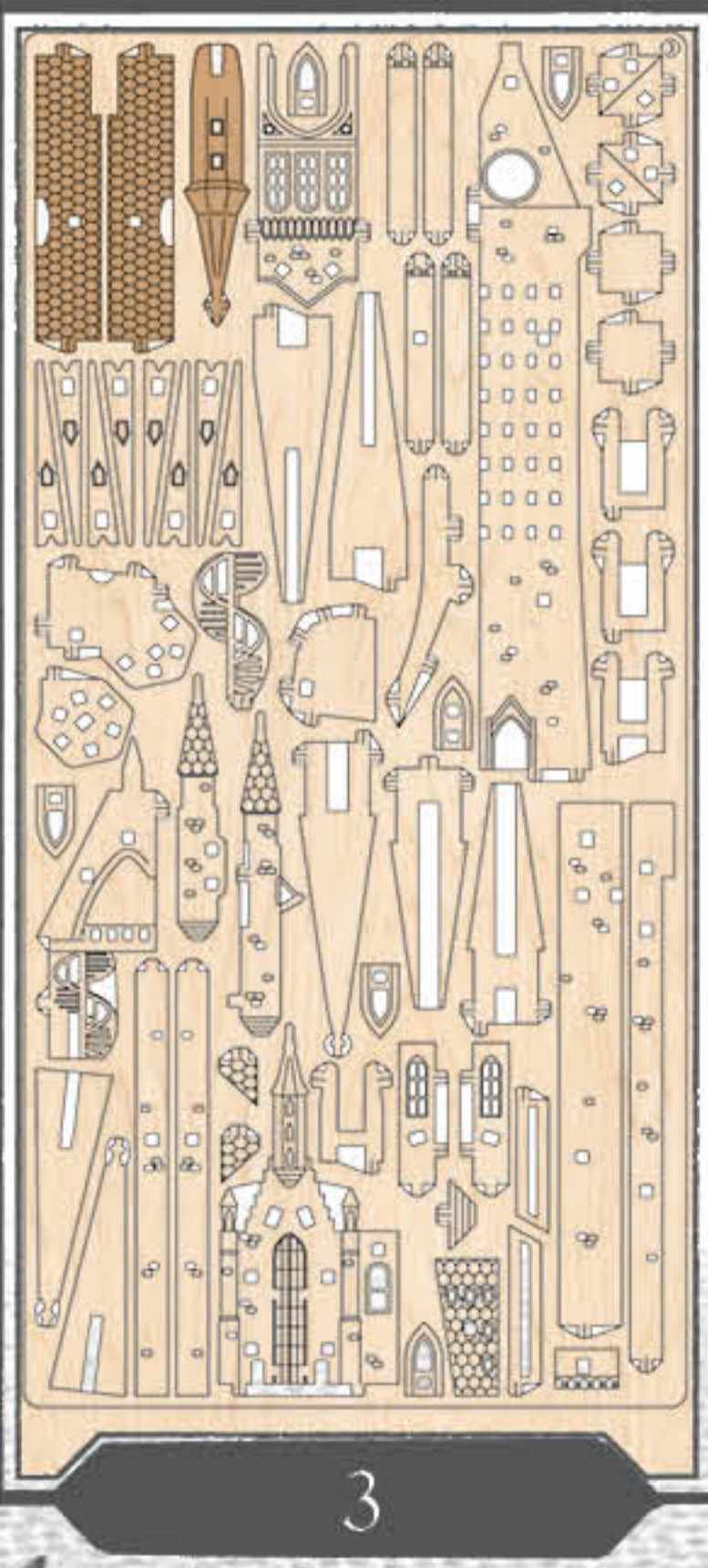
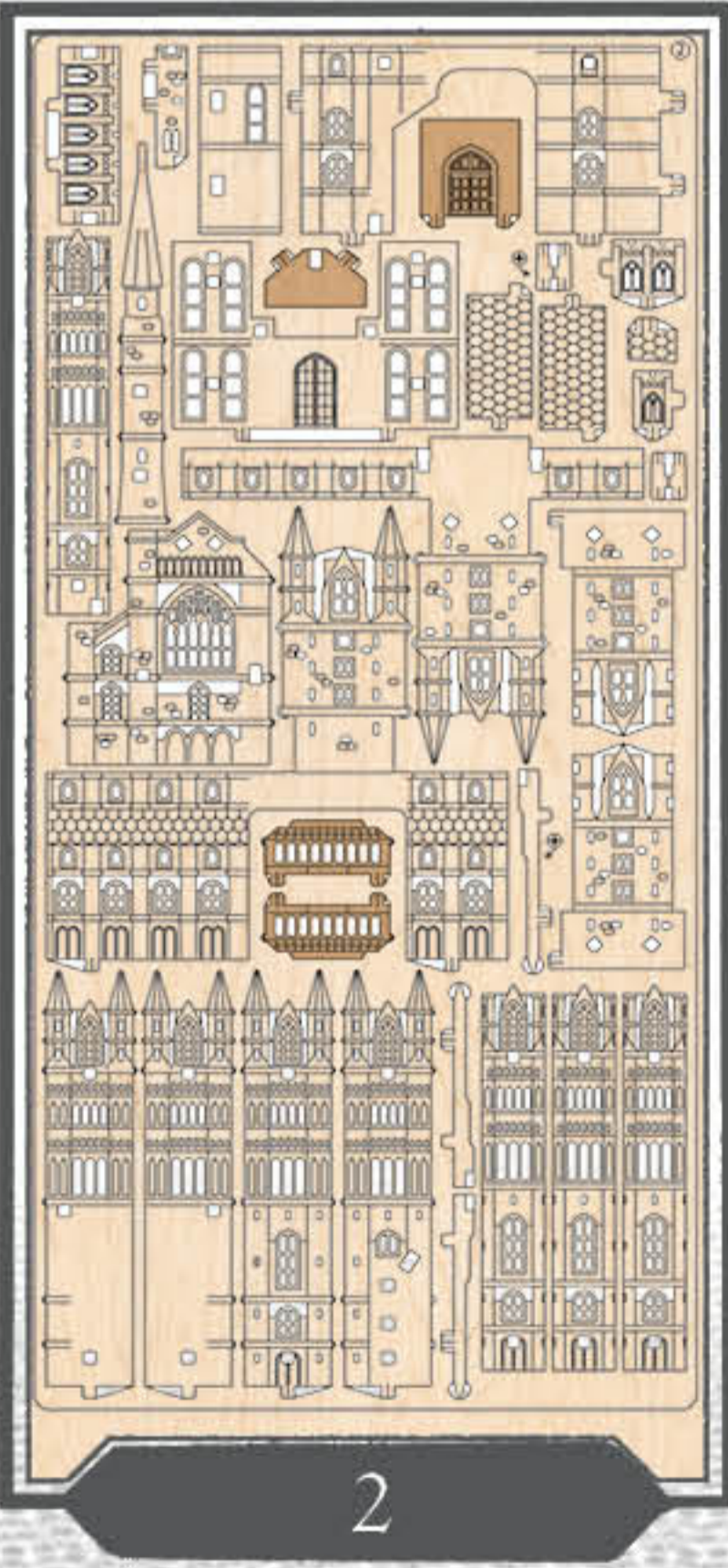
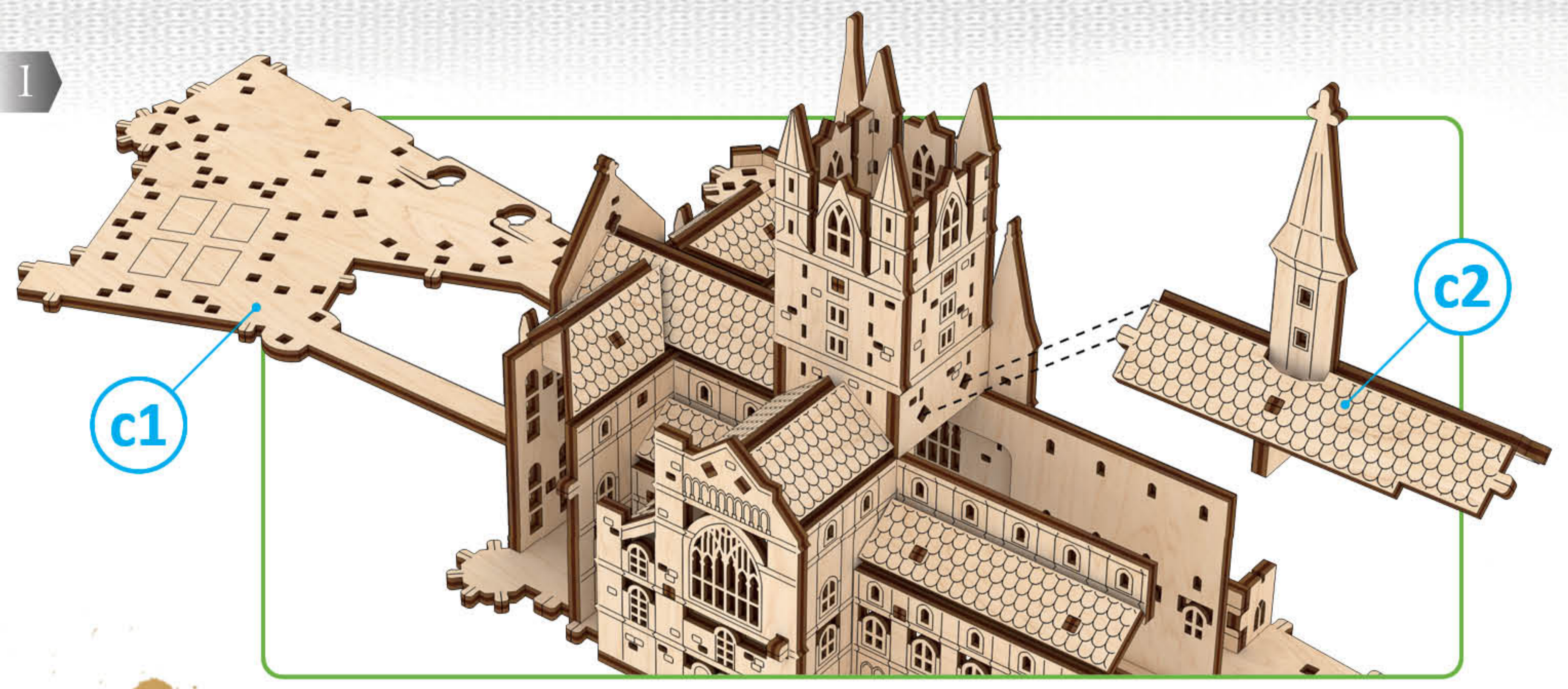

2

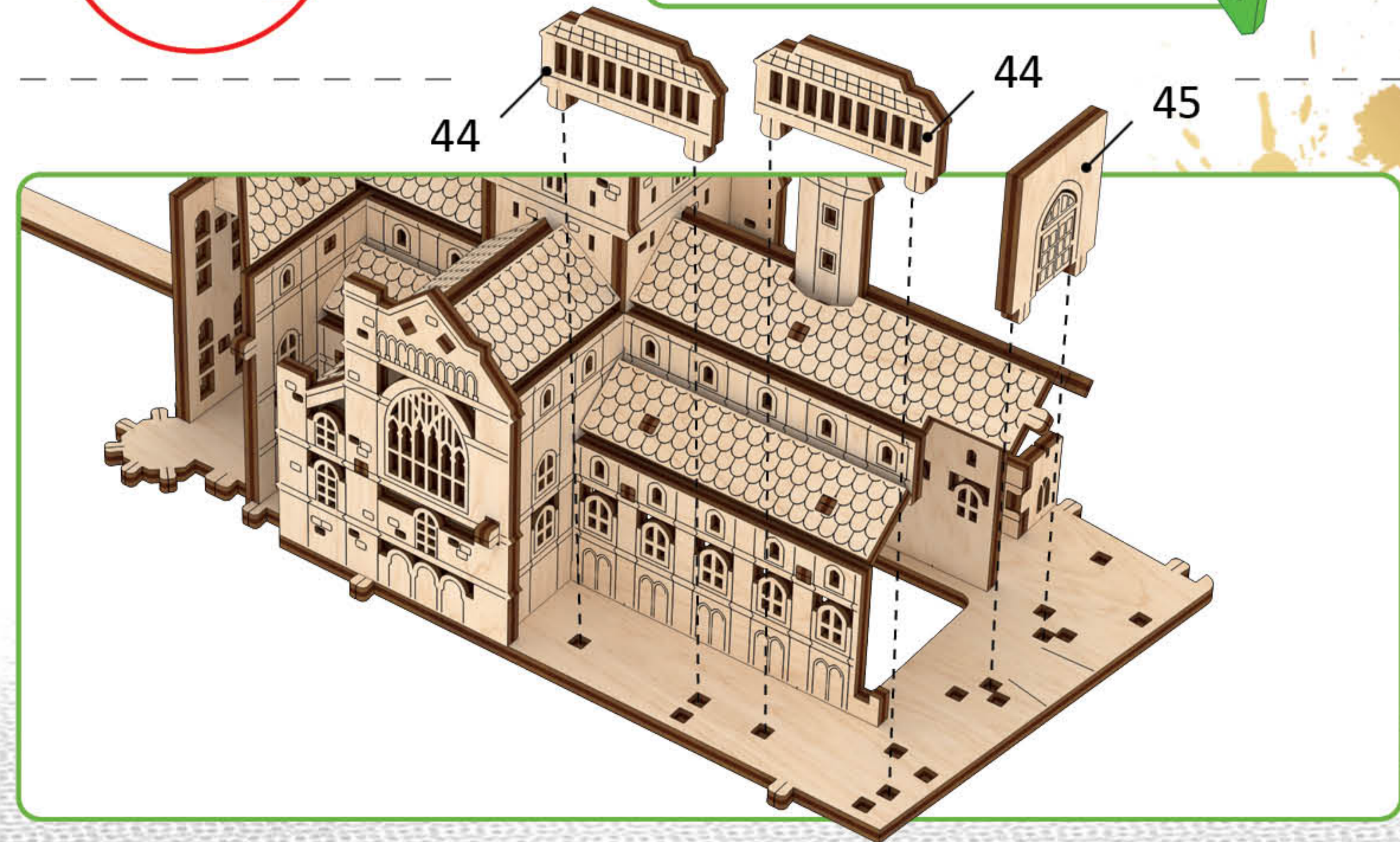

c

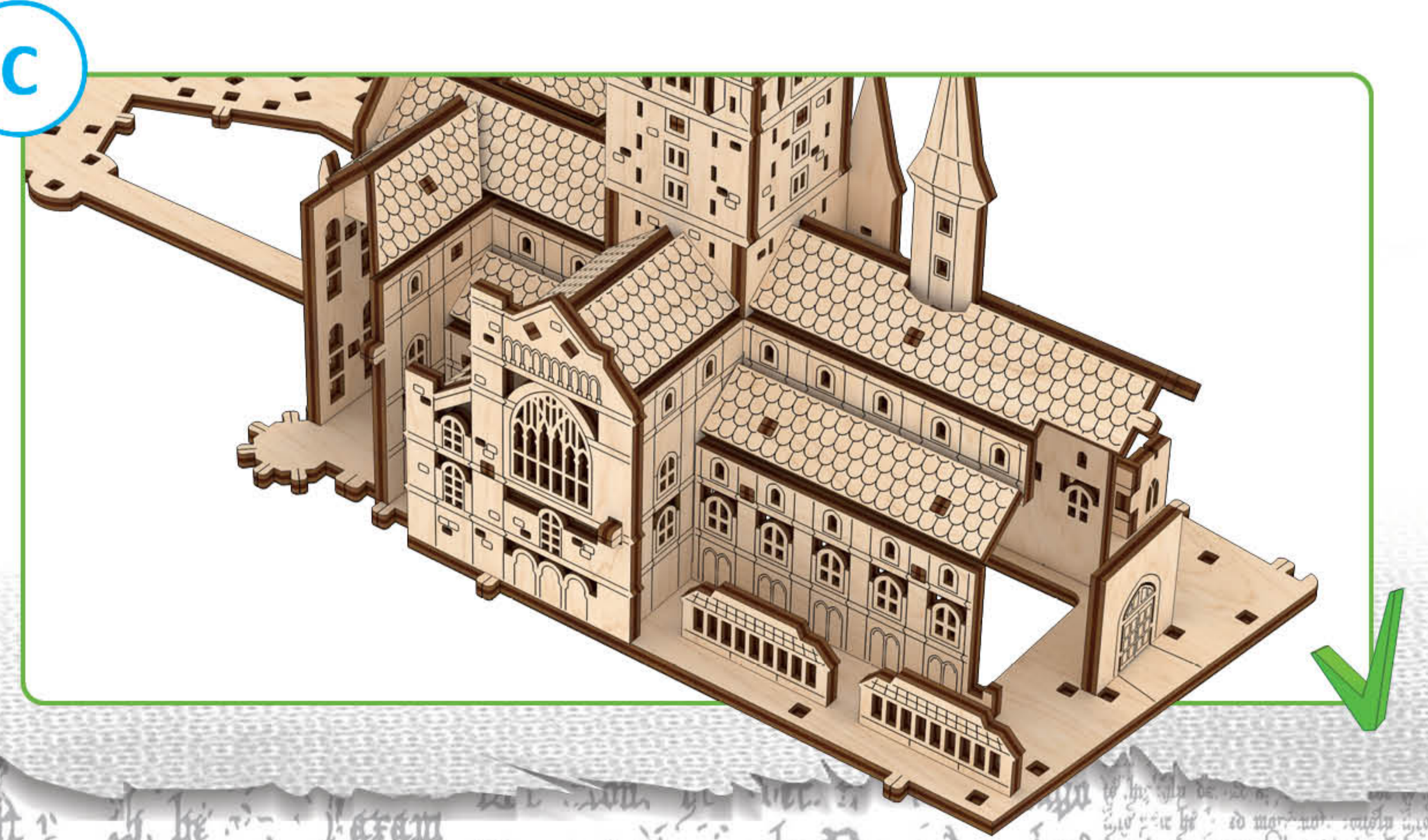

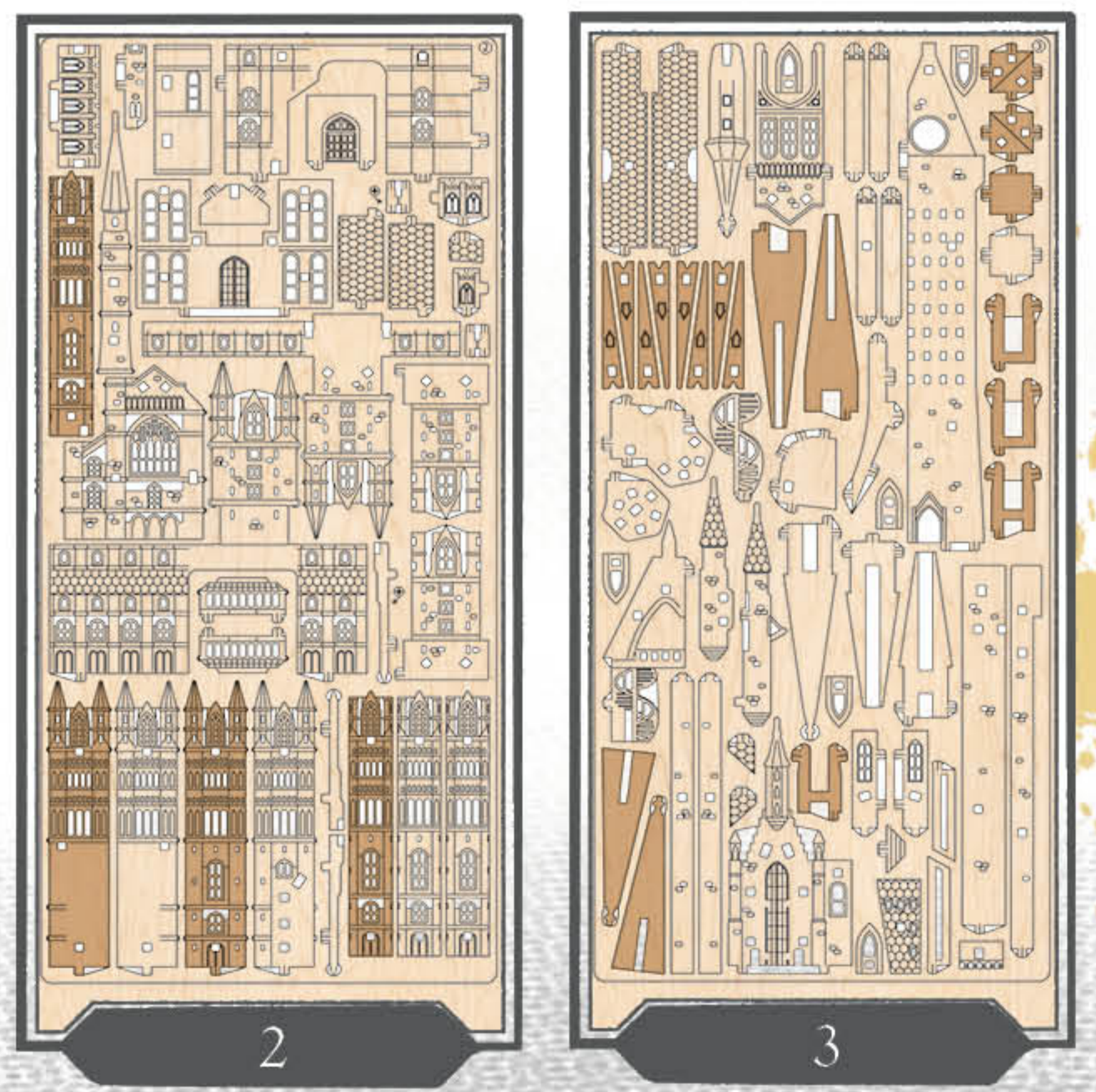
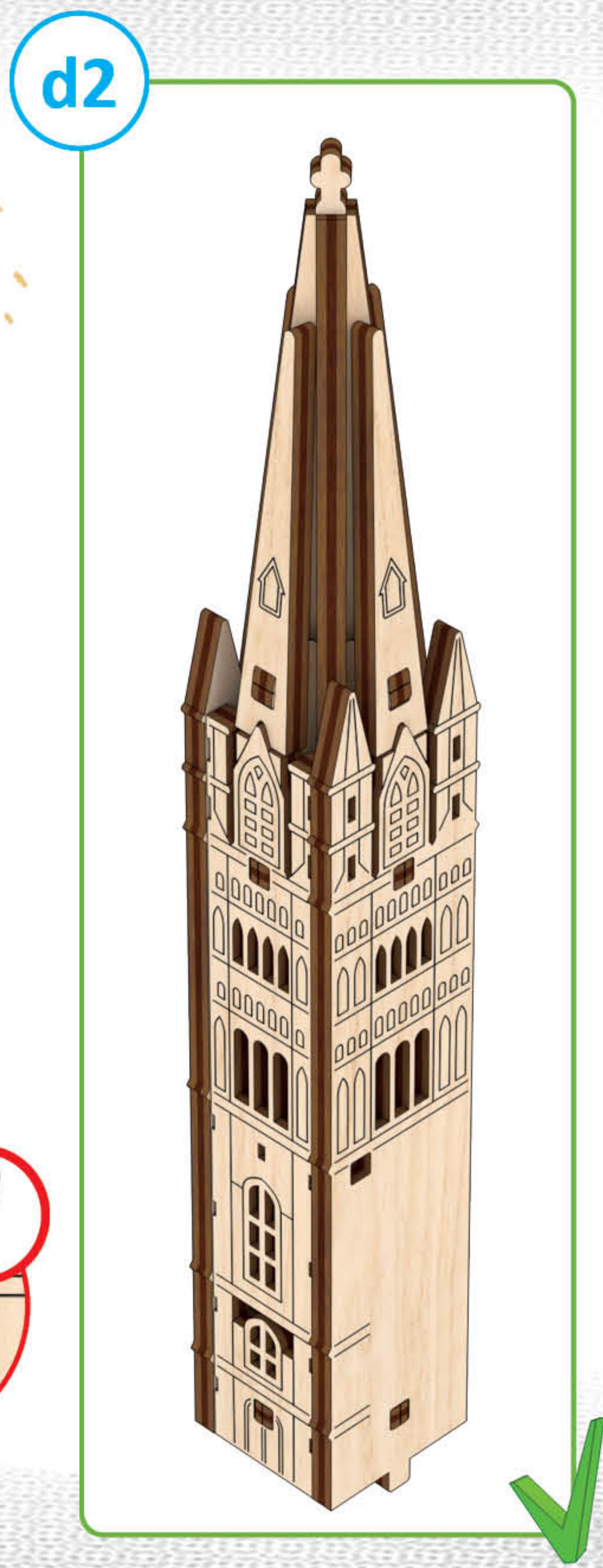
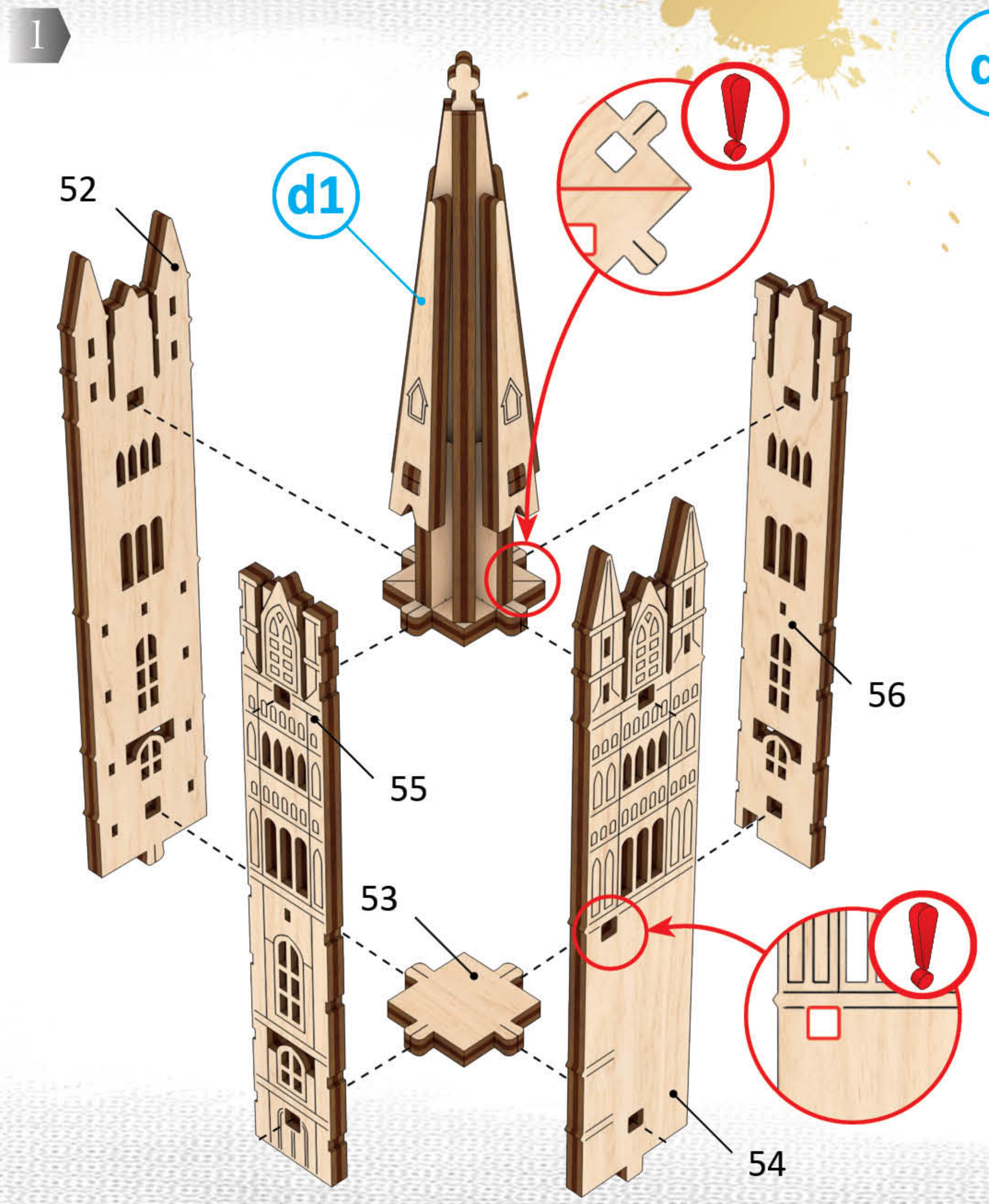
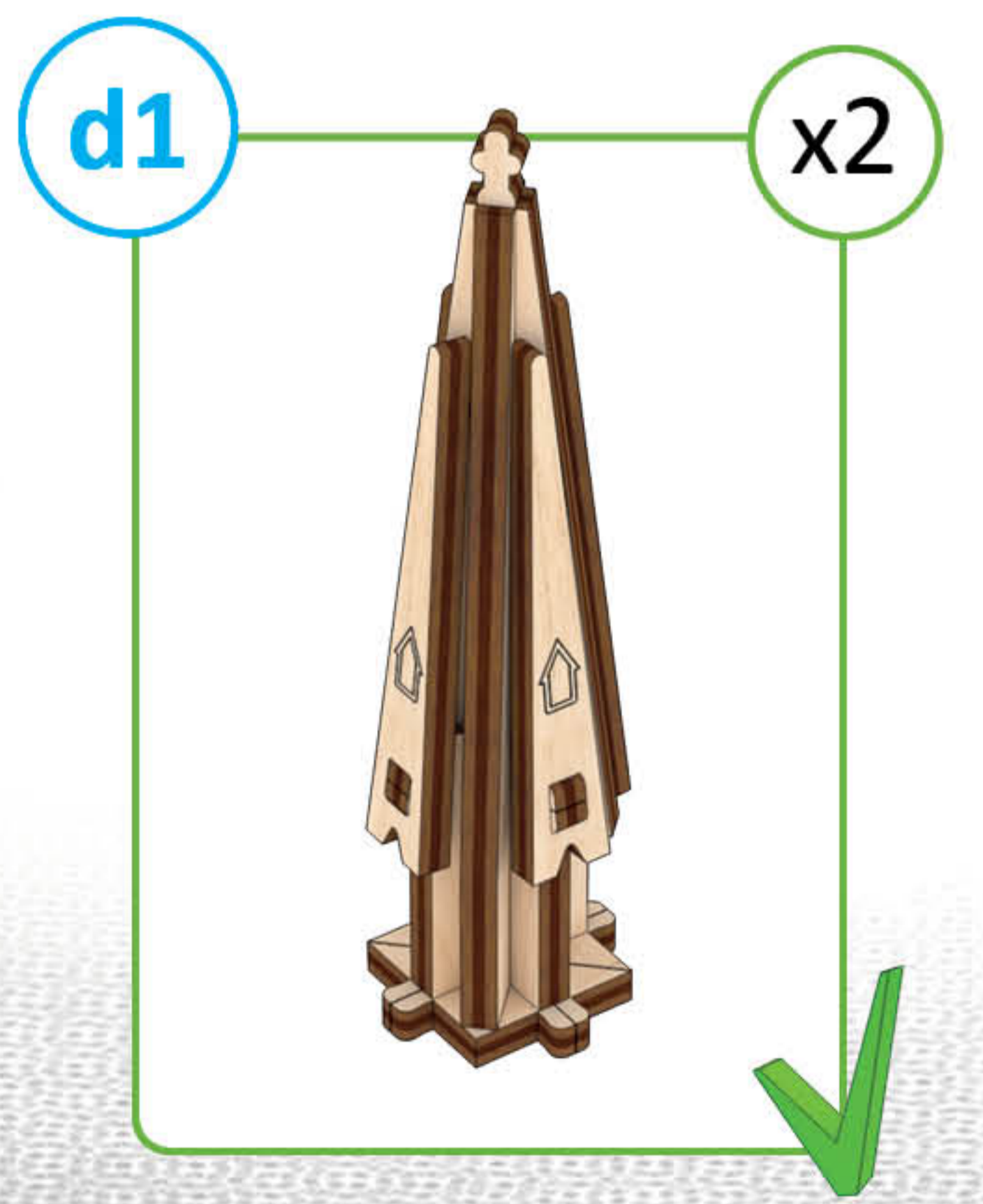
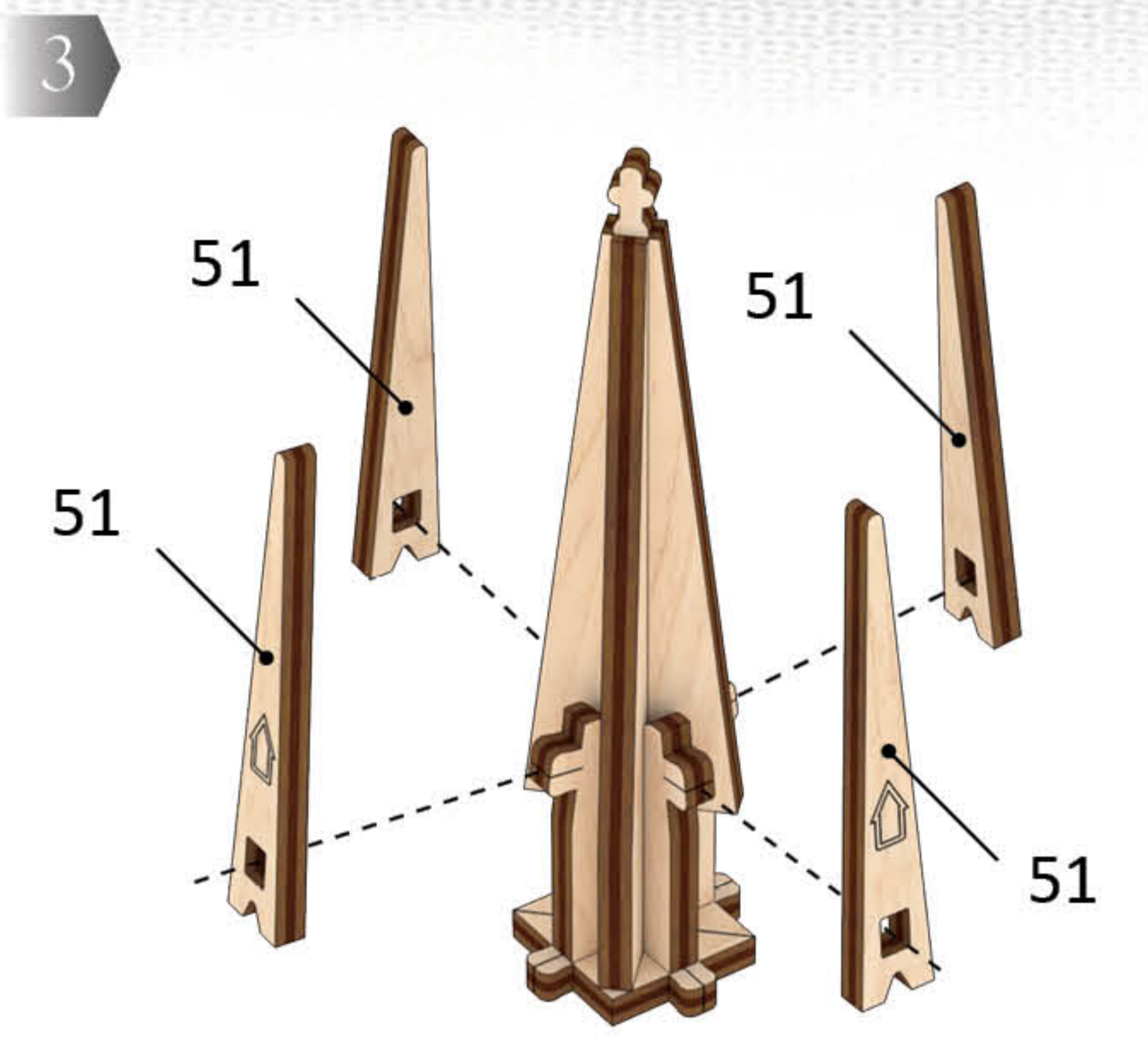
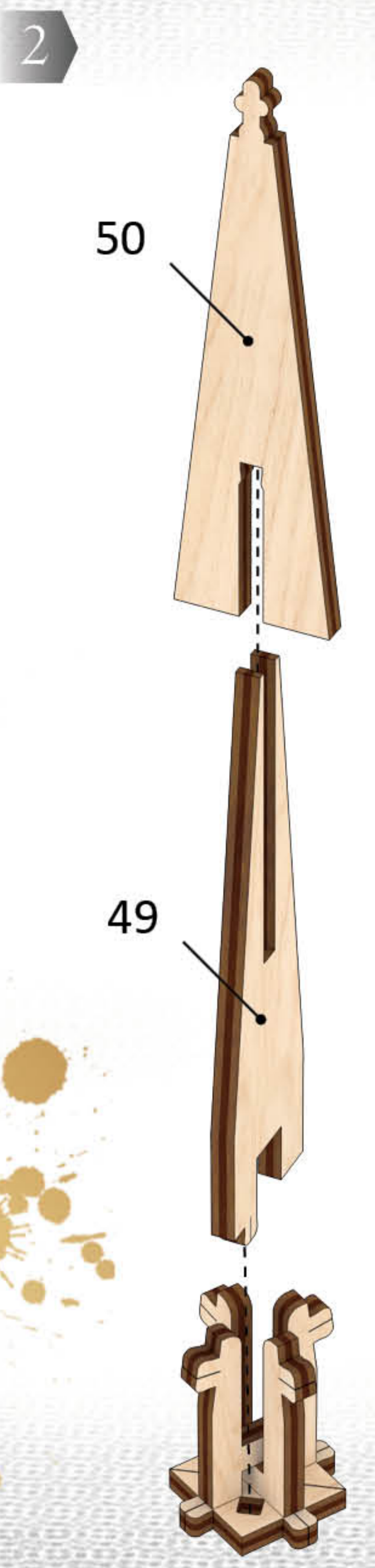
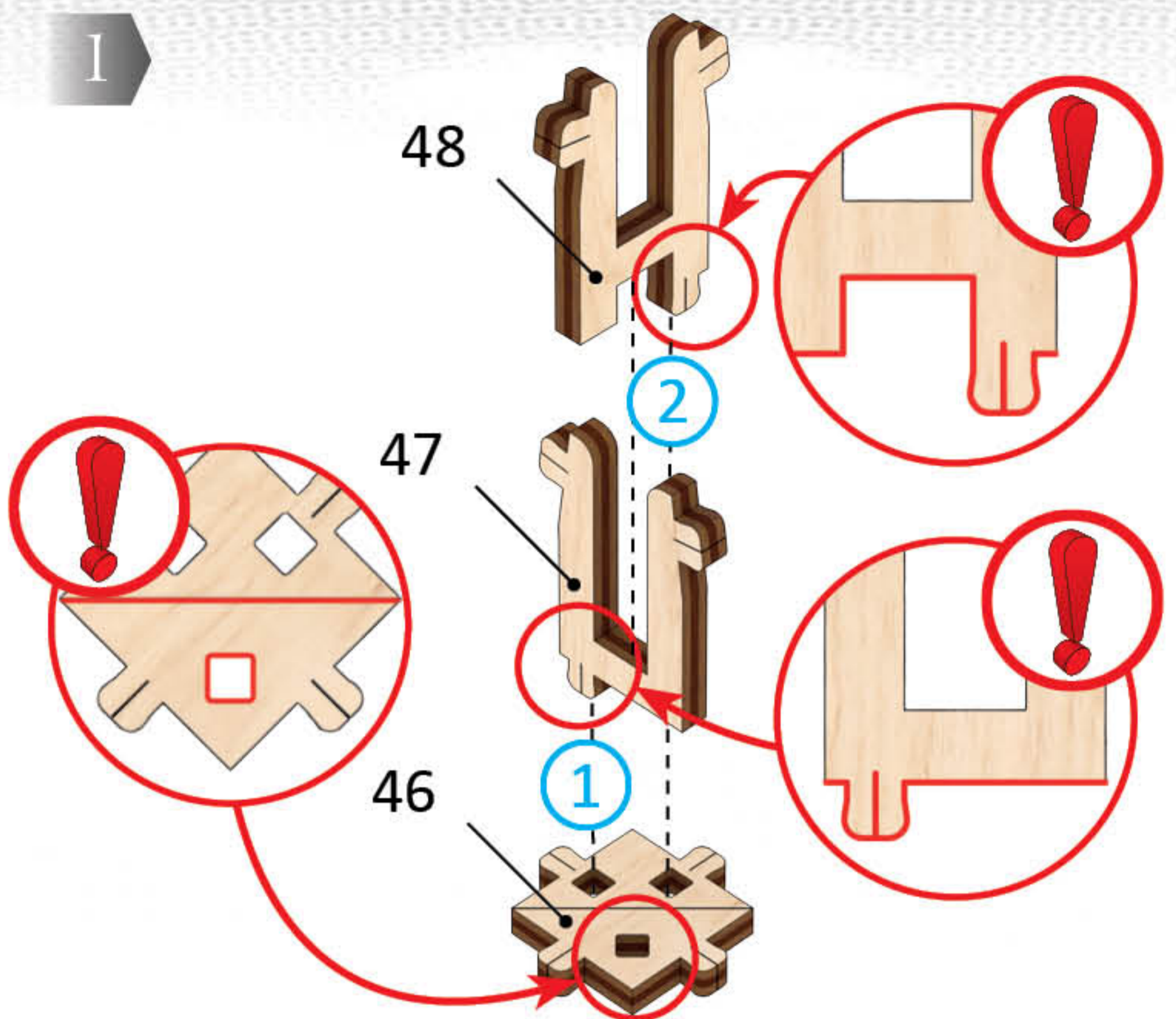

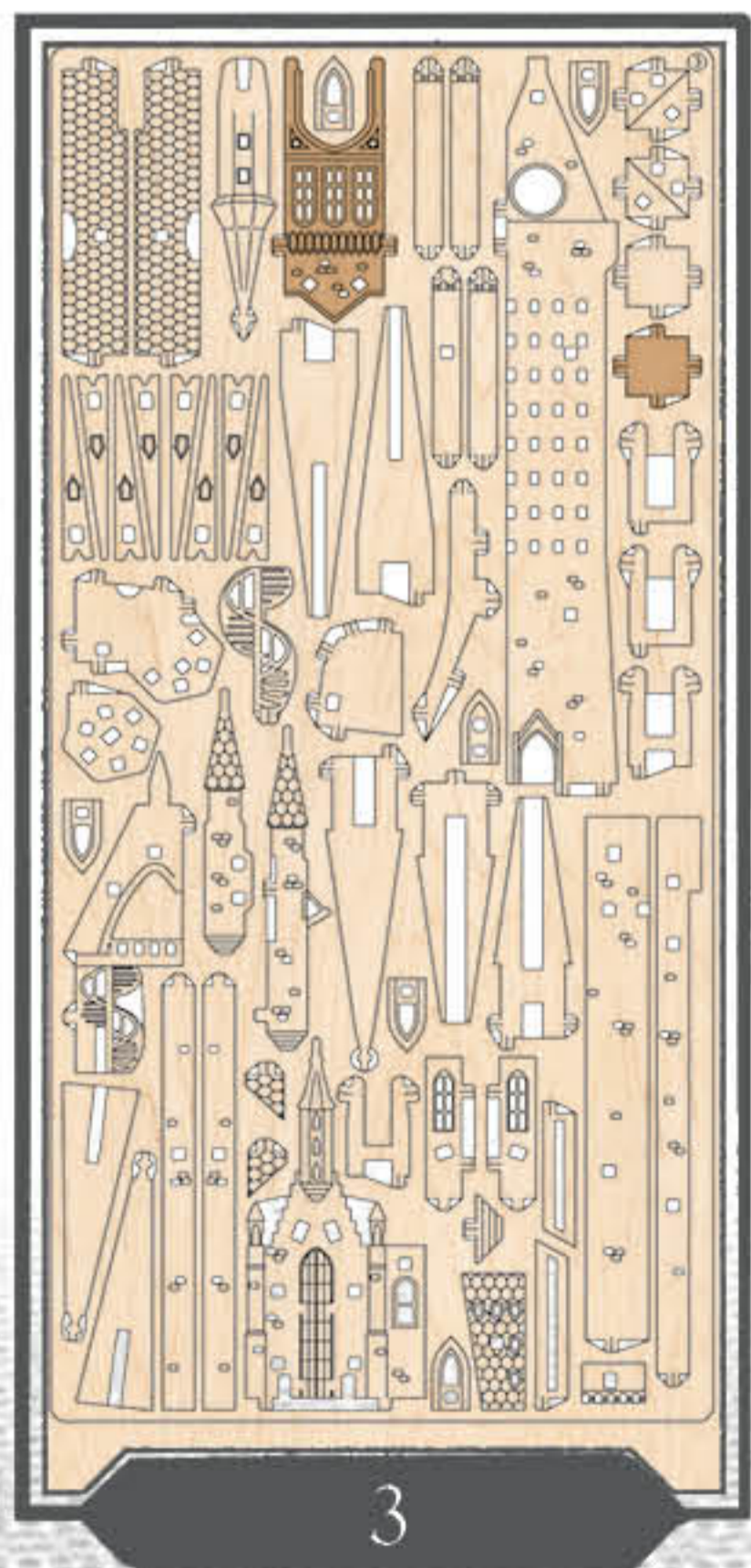
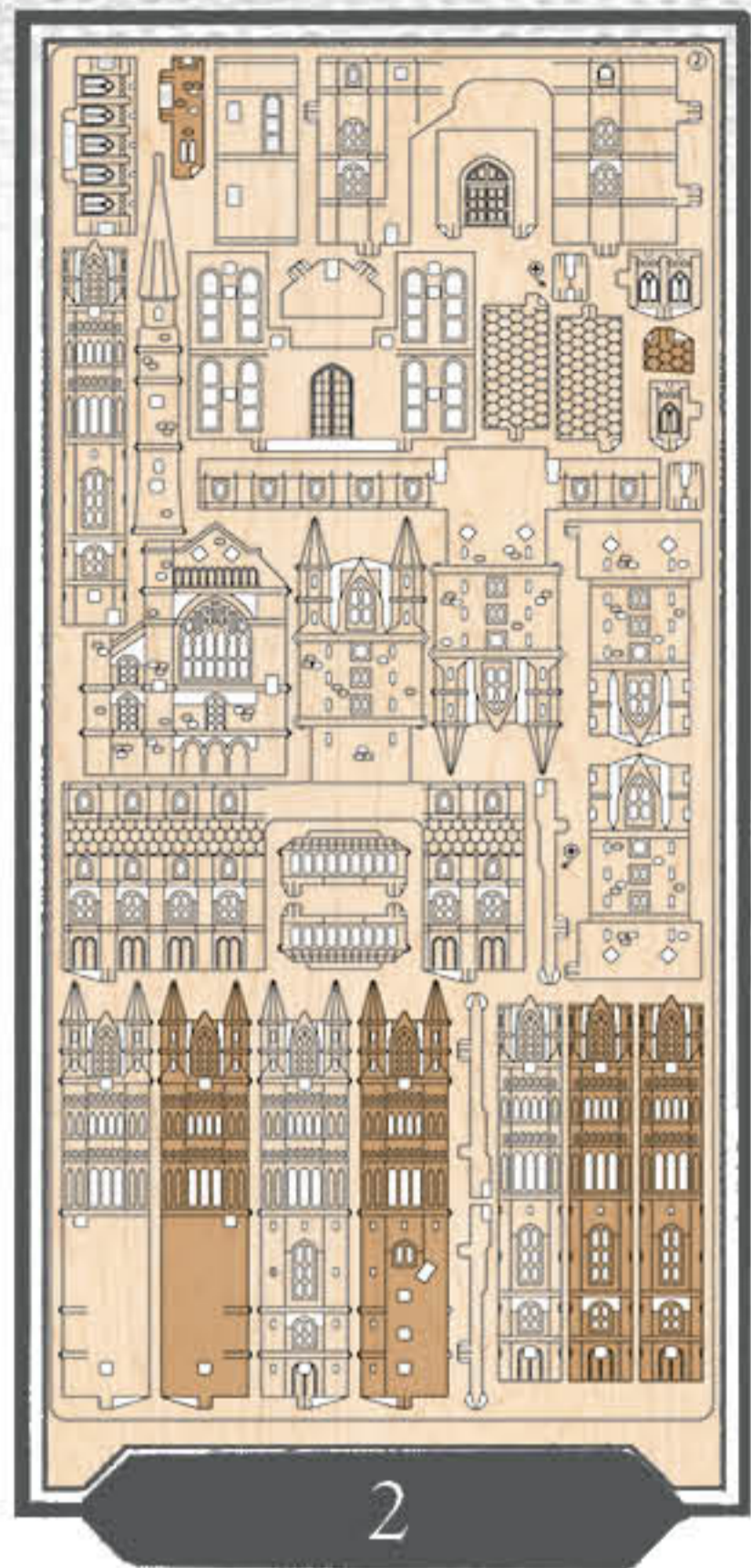

1

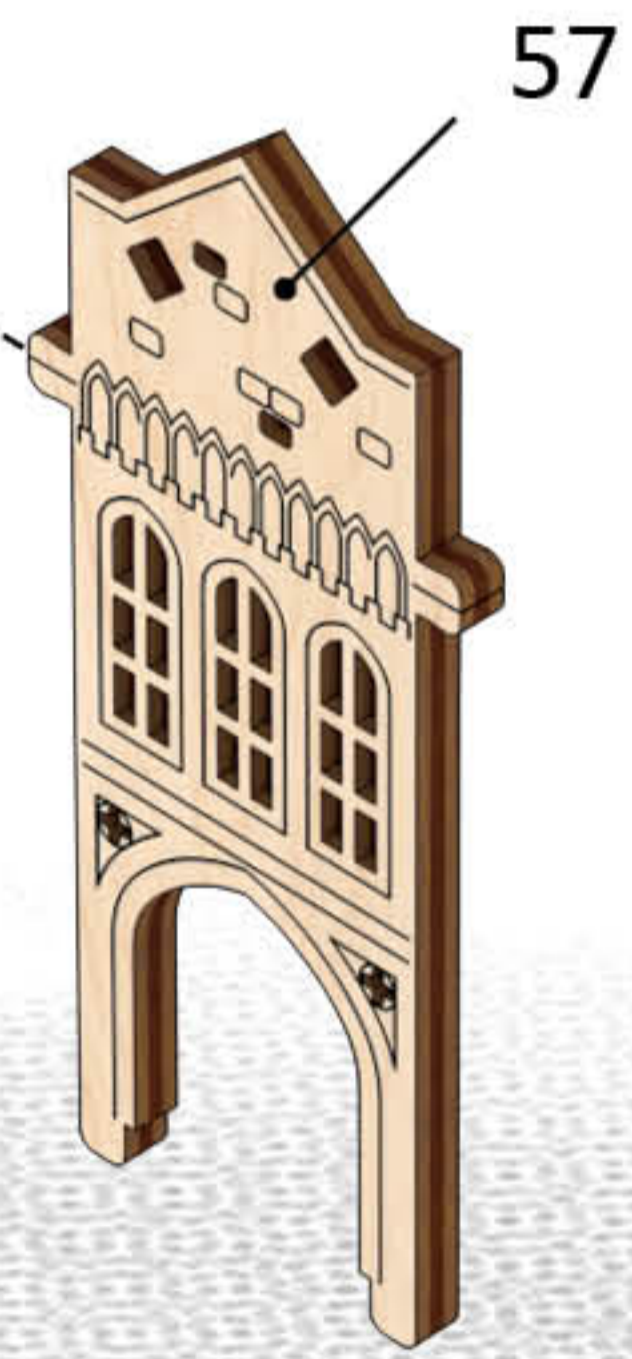
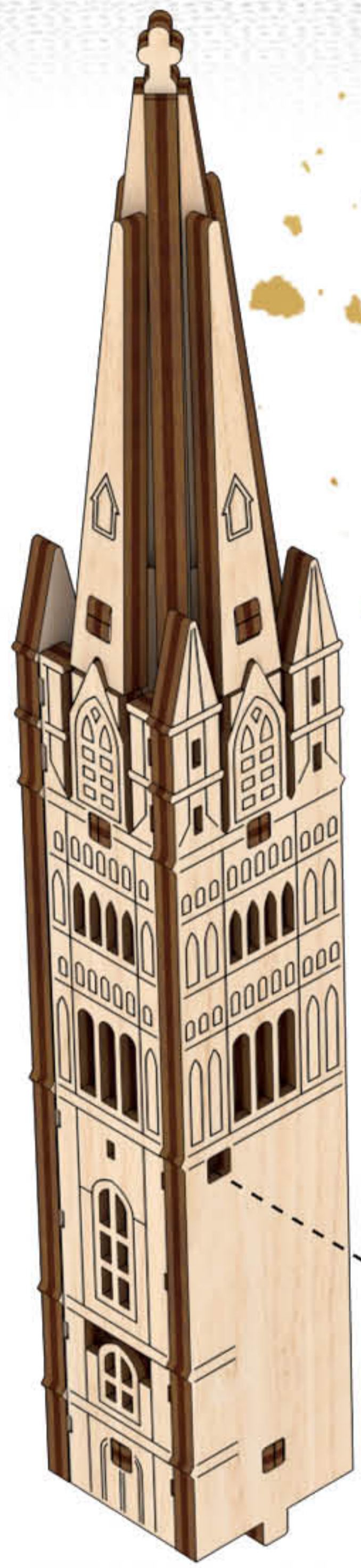

d3

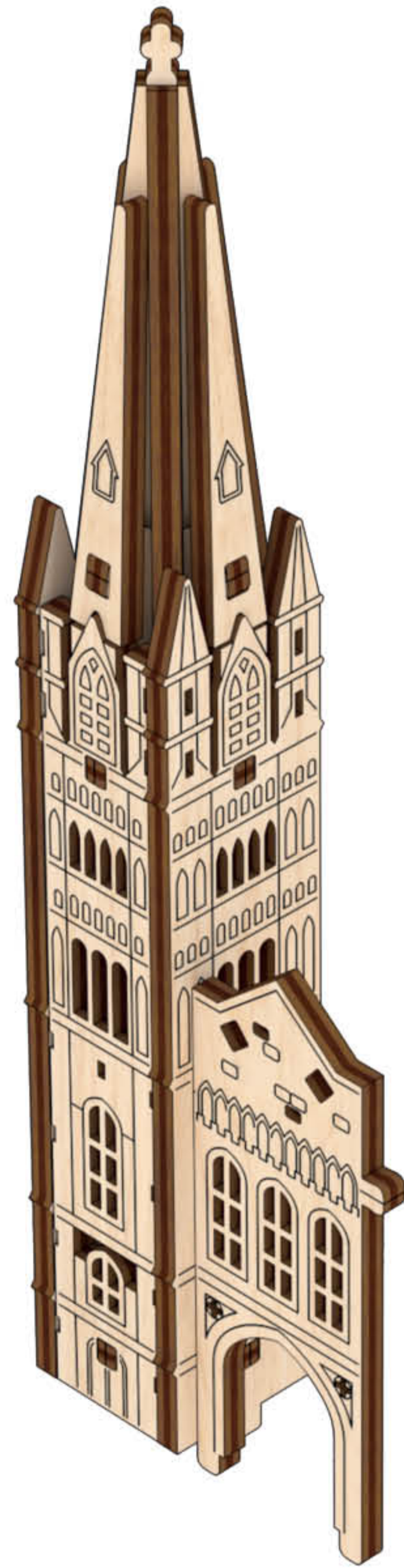

1

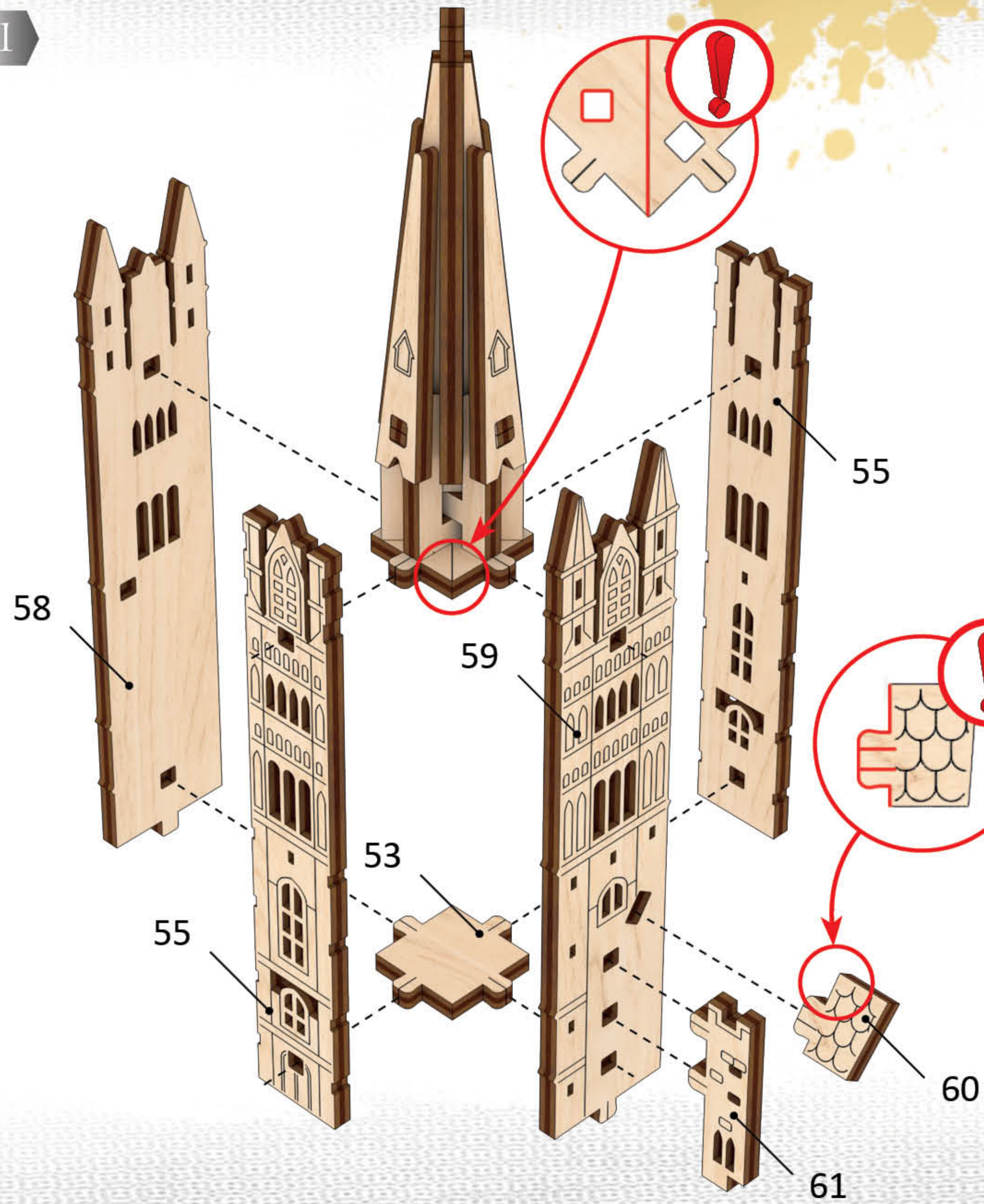

d4



1

1

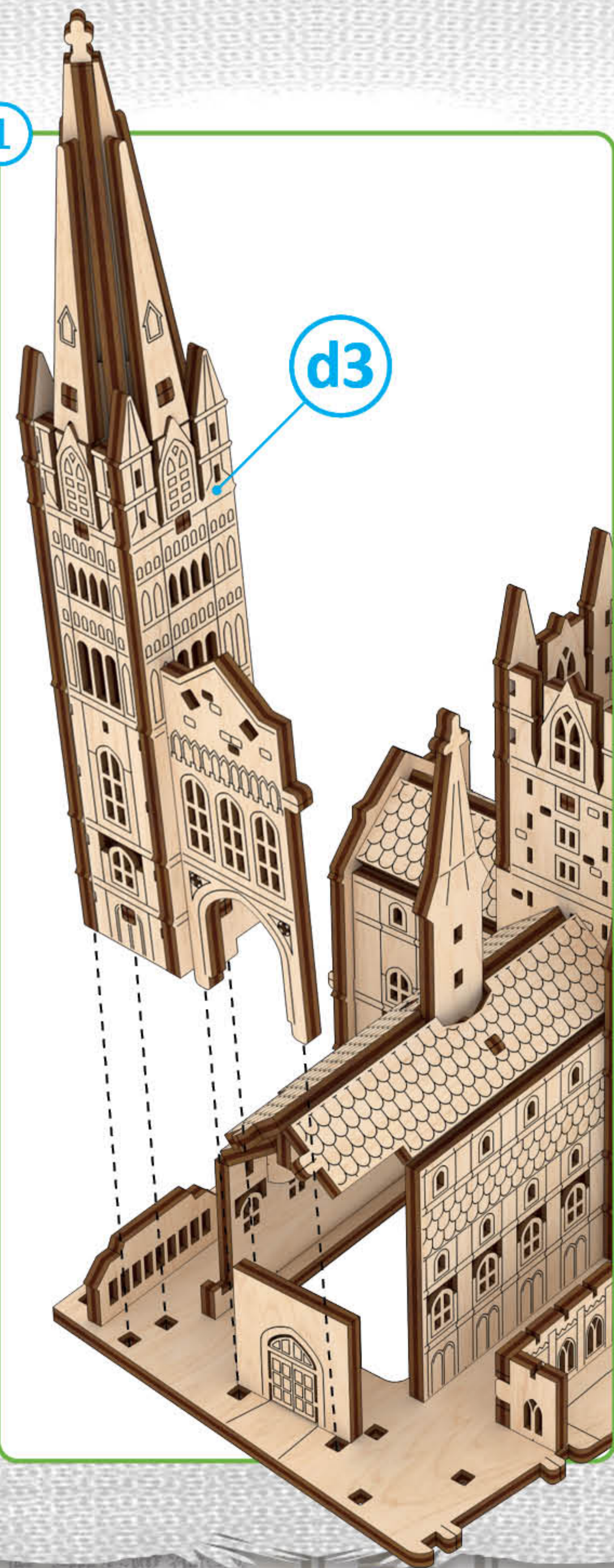

2

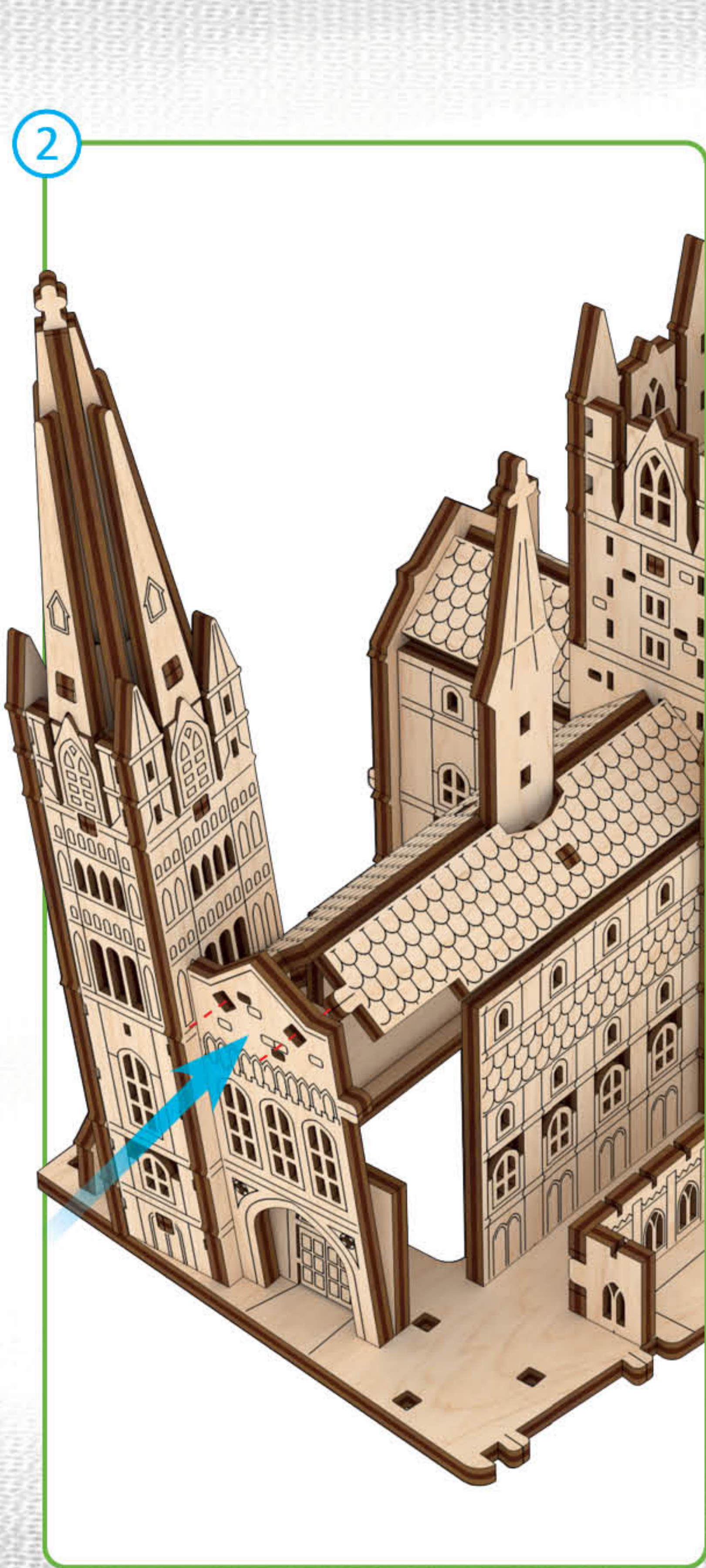

2

1

d4

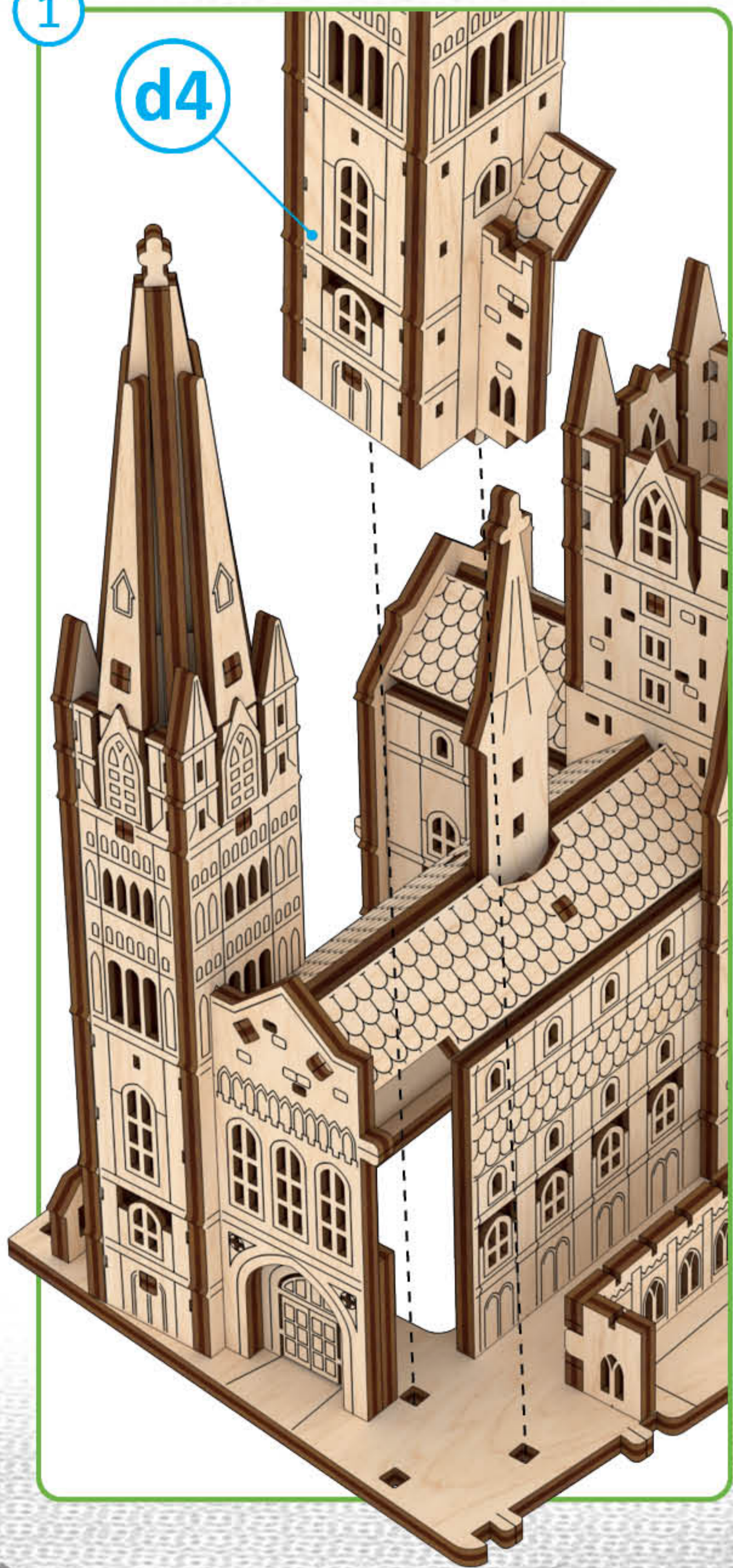

2

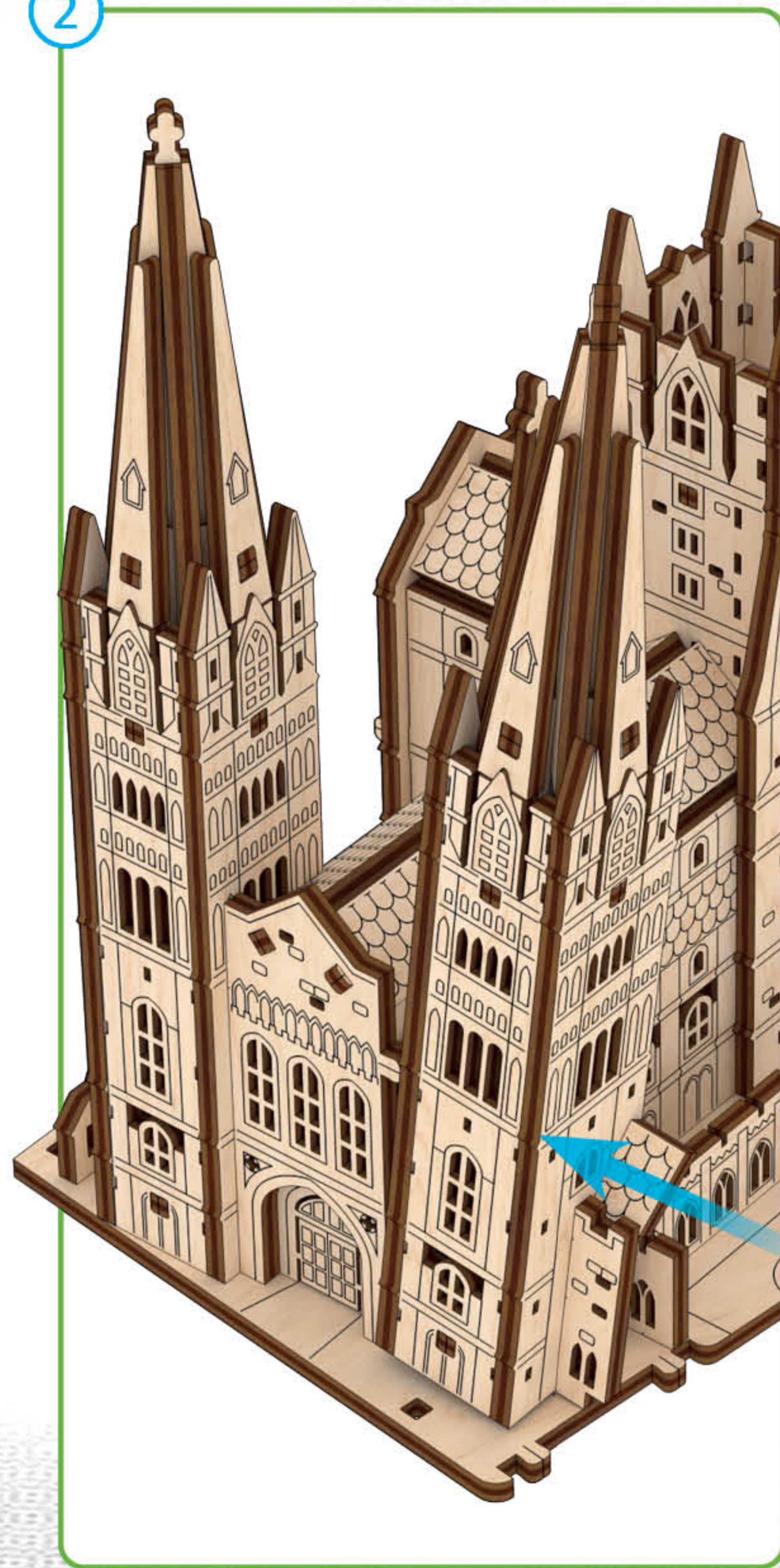

D

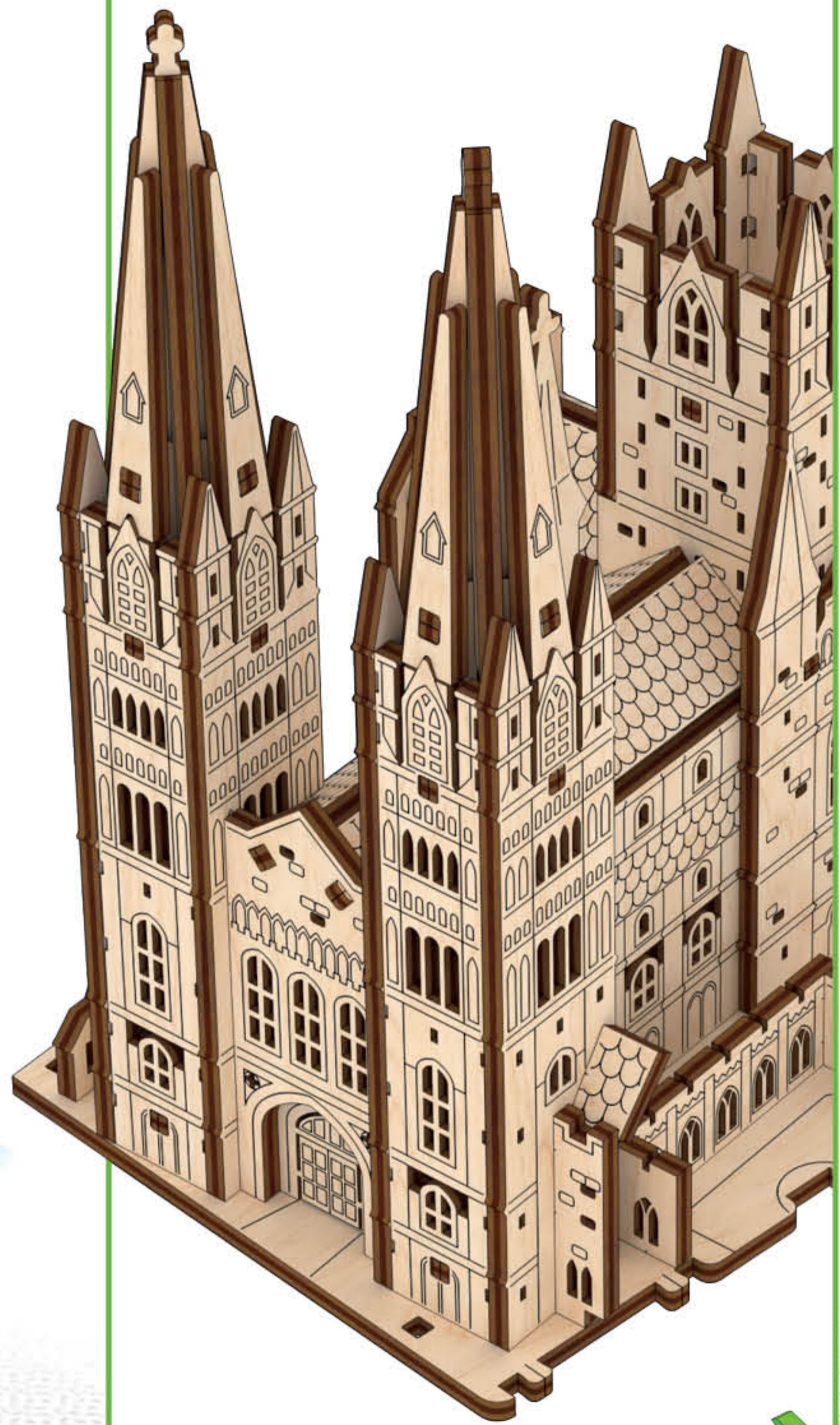

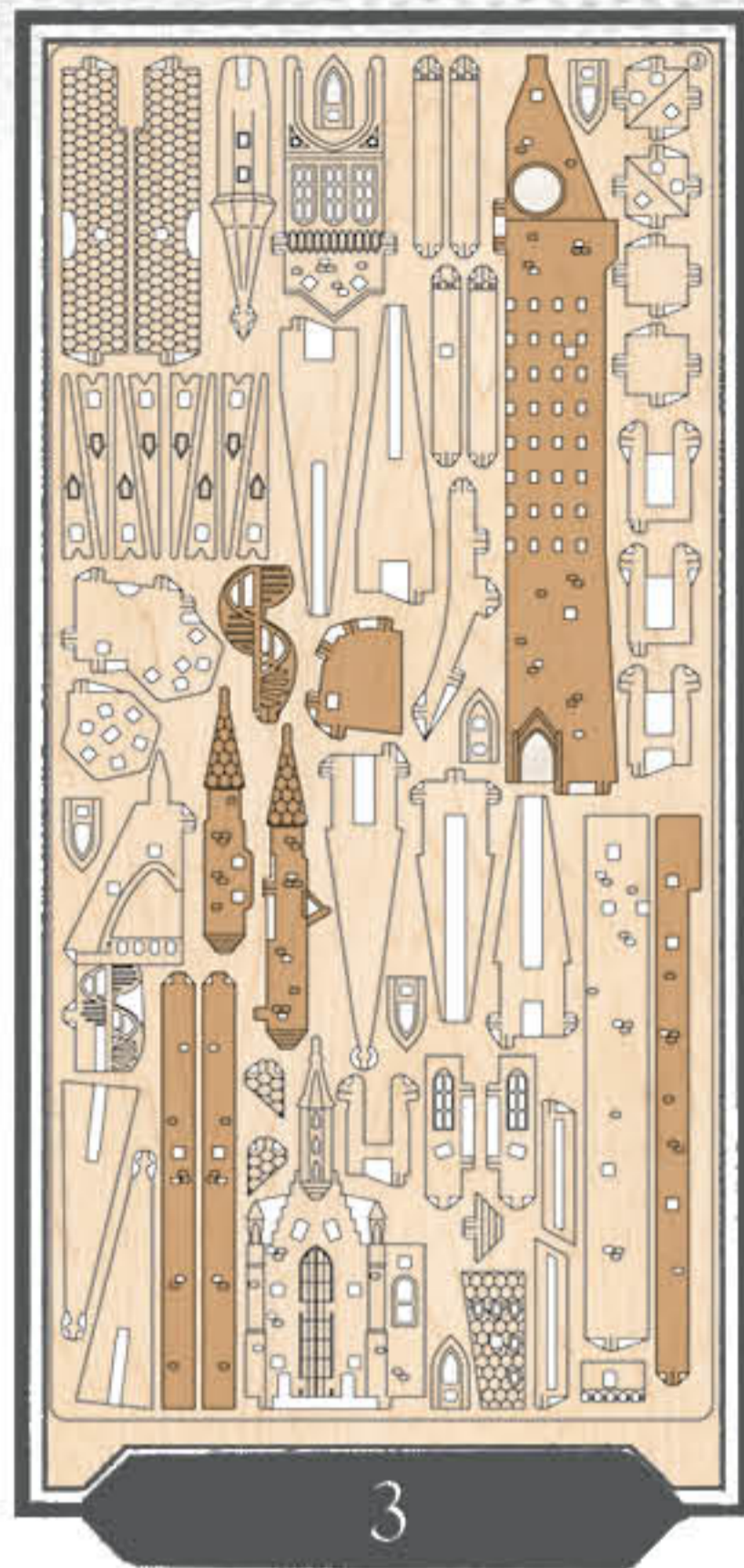

1

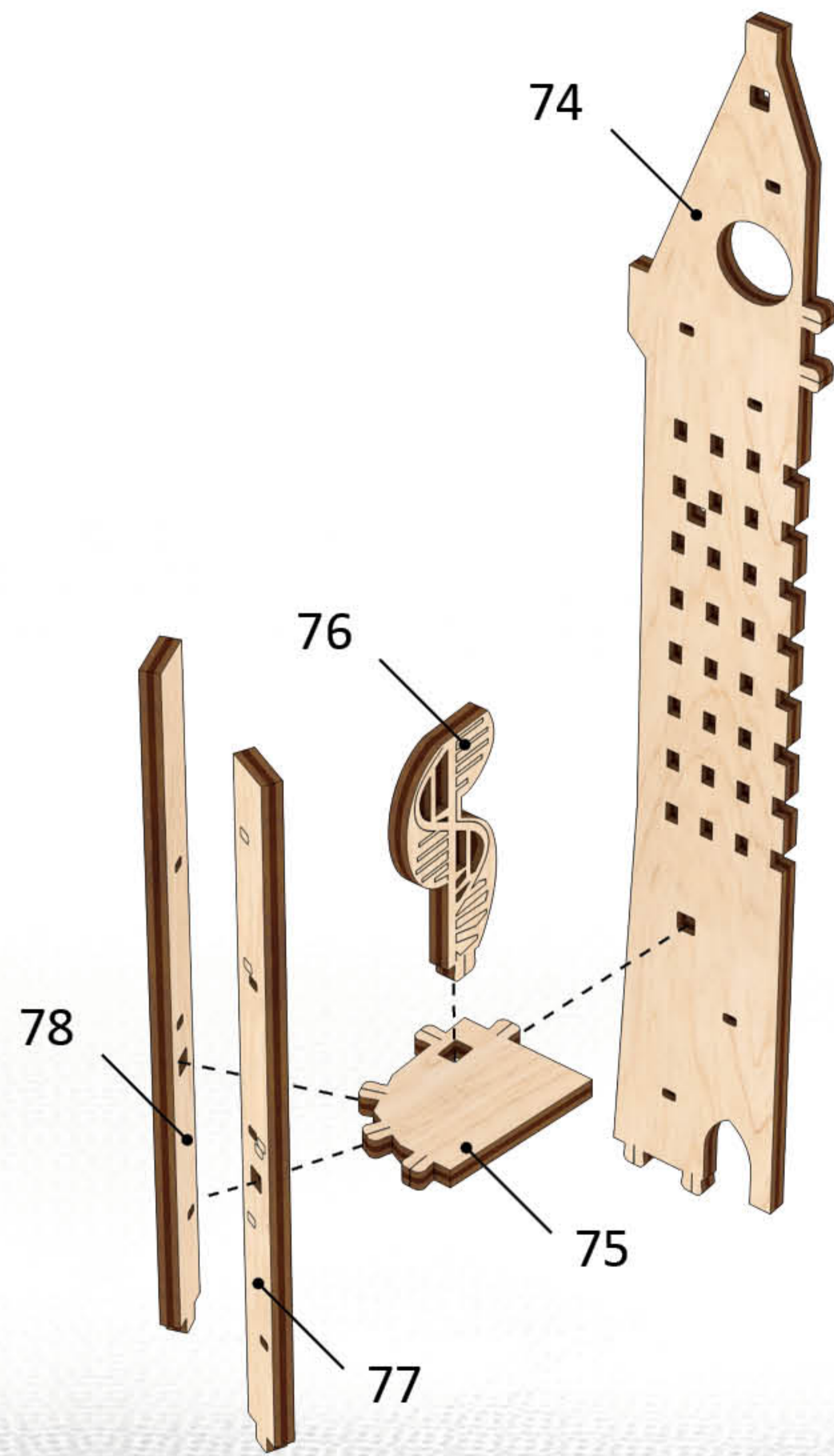

2

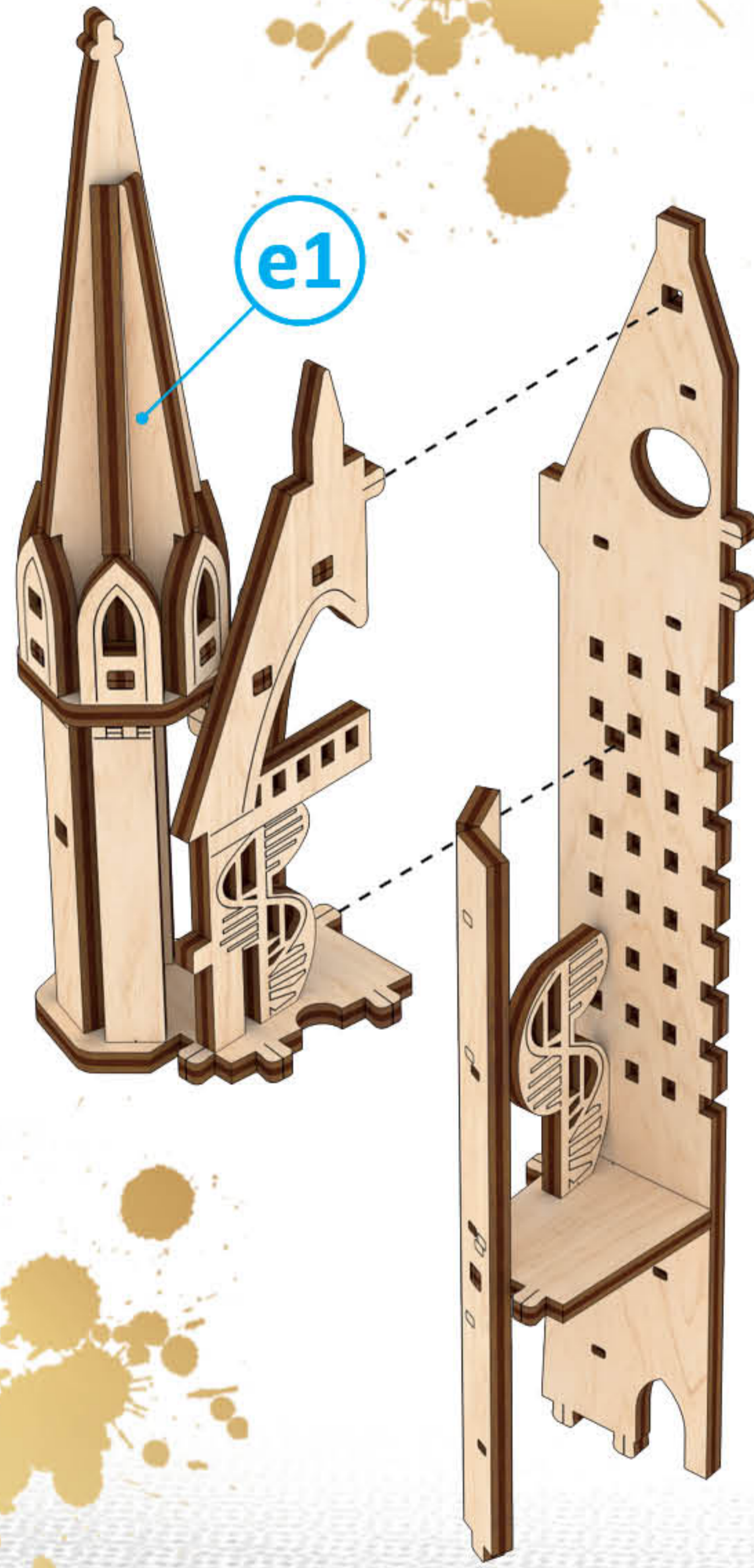

3

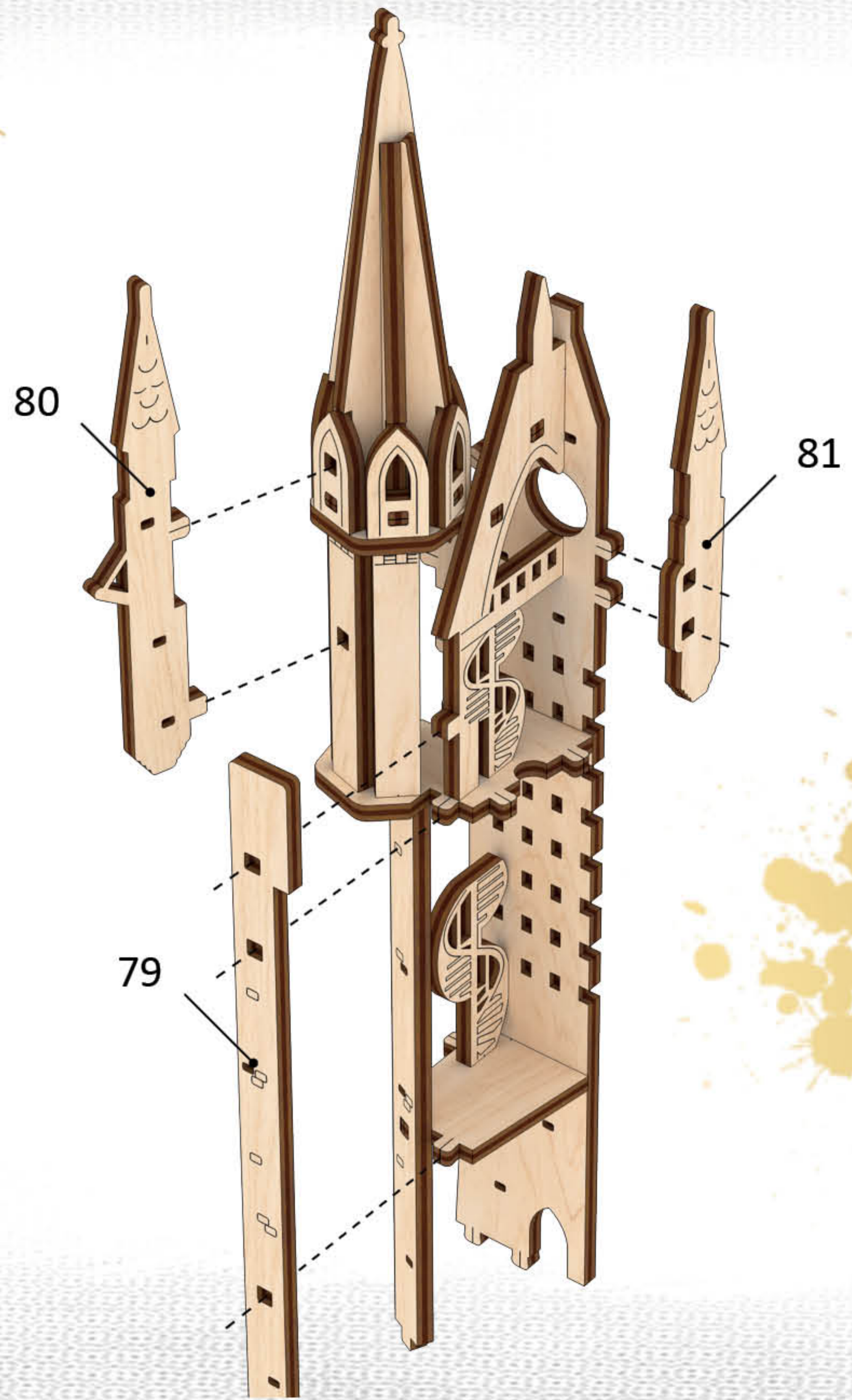

4

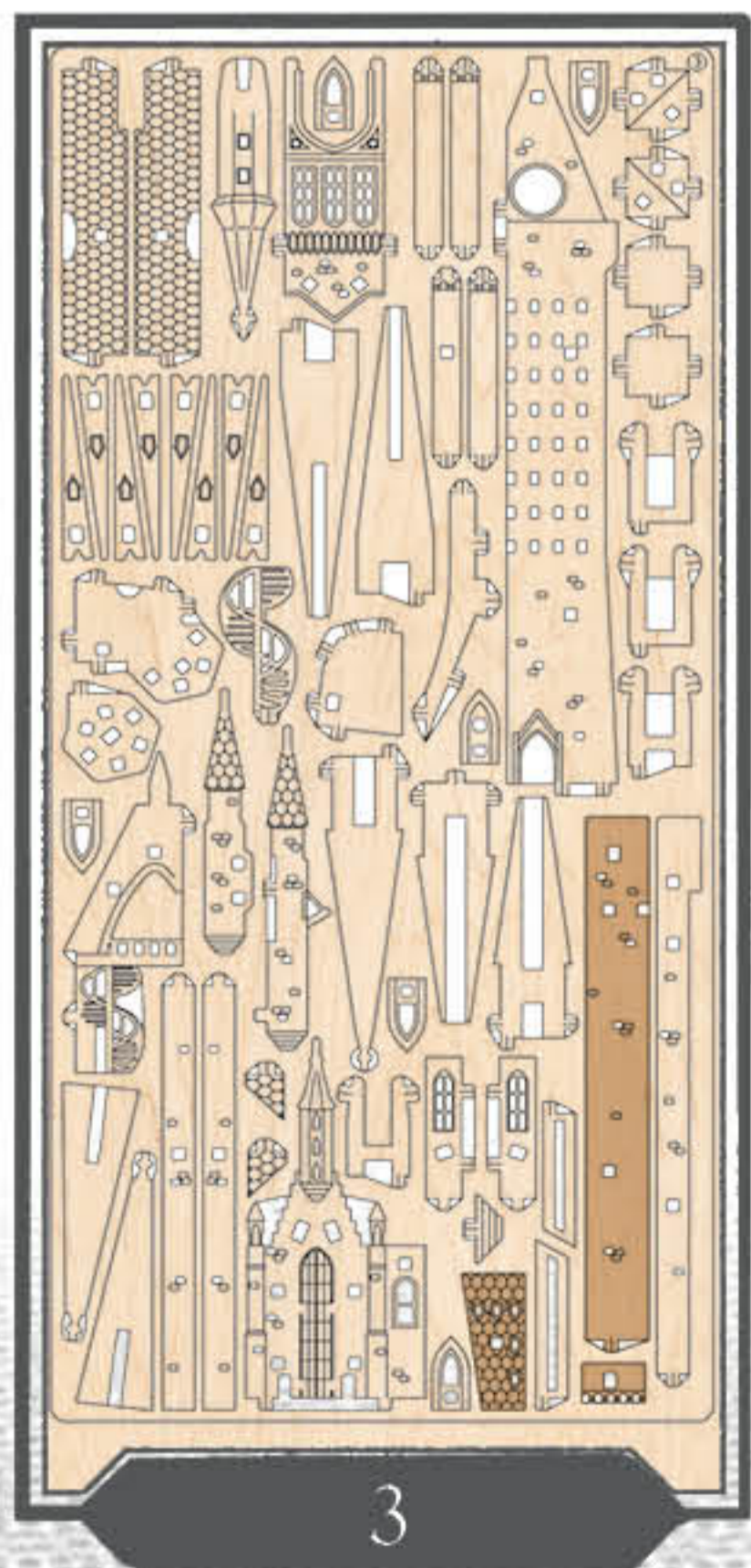

3

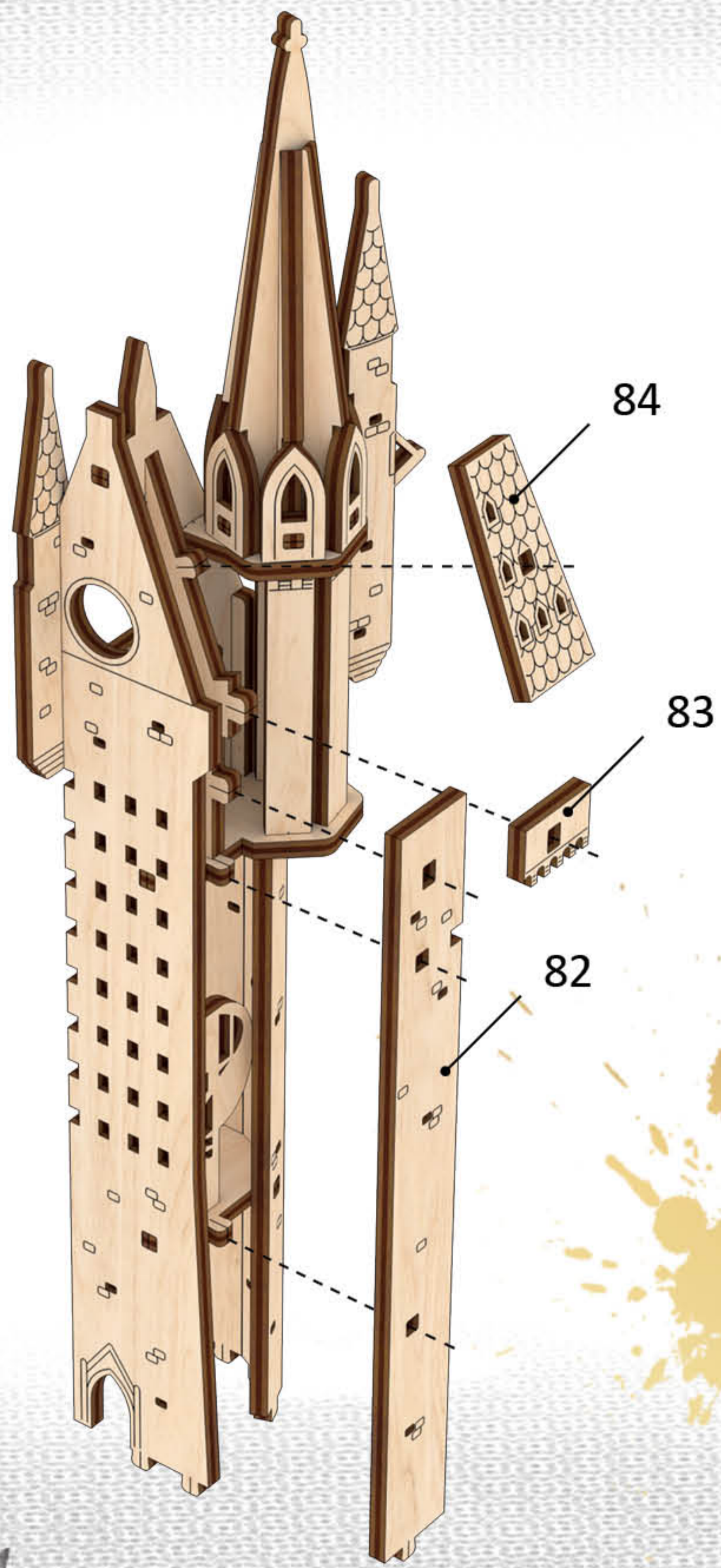

e2

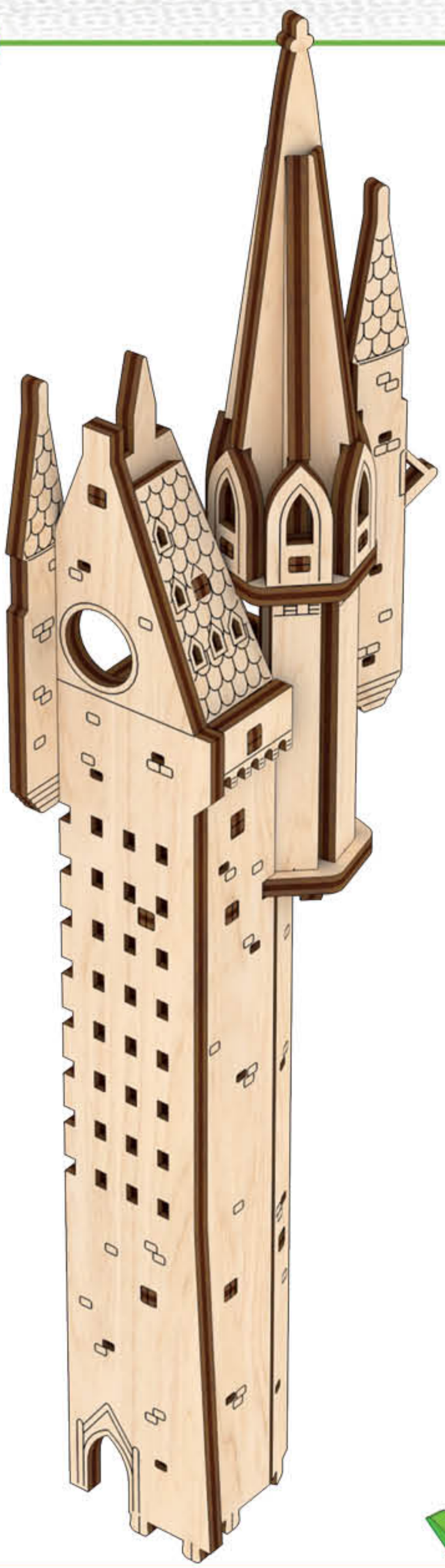

1

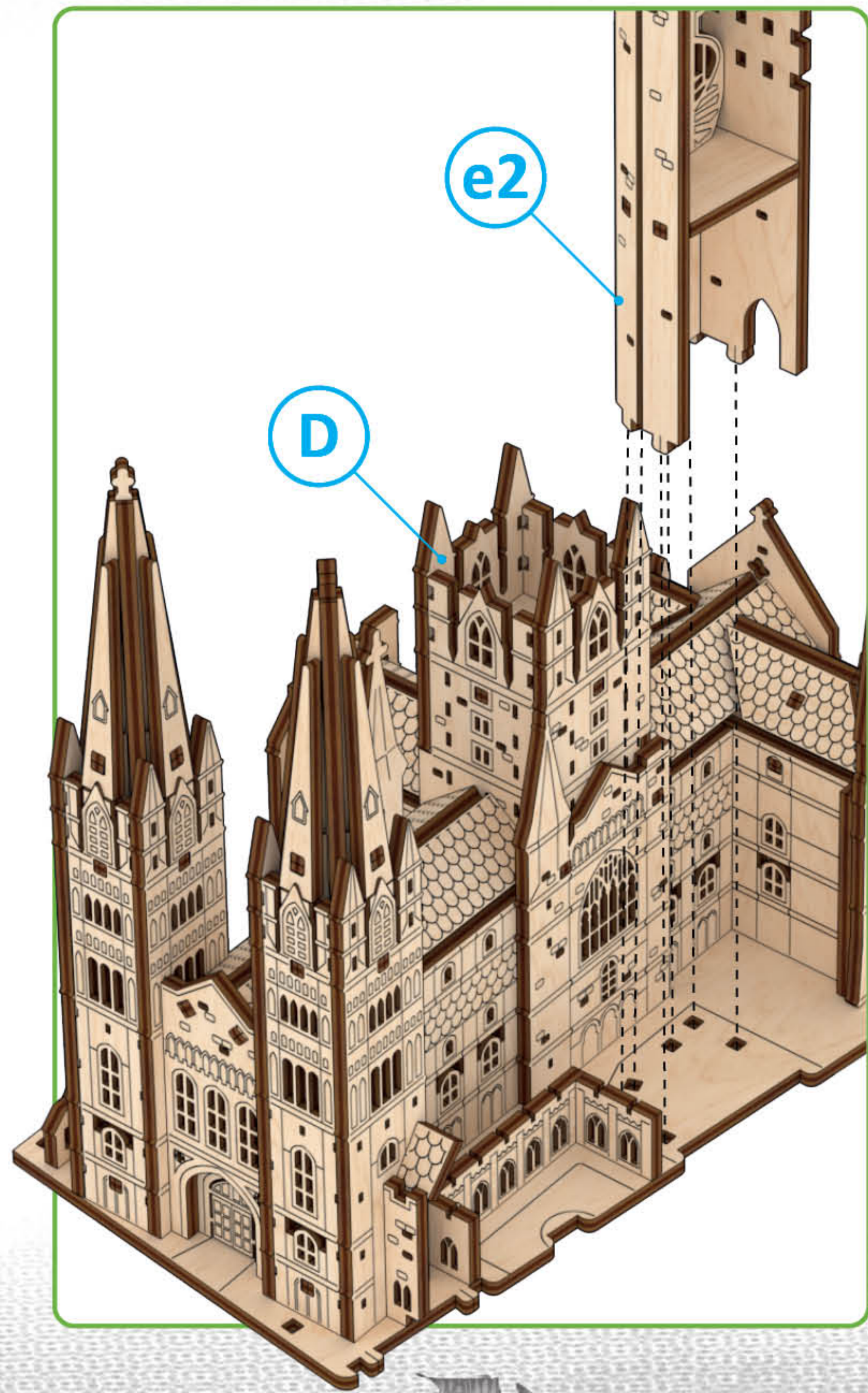

E



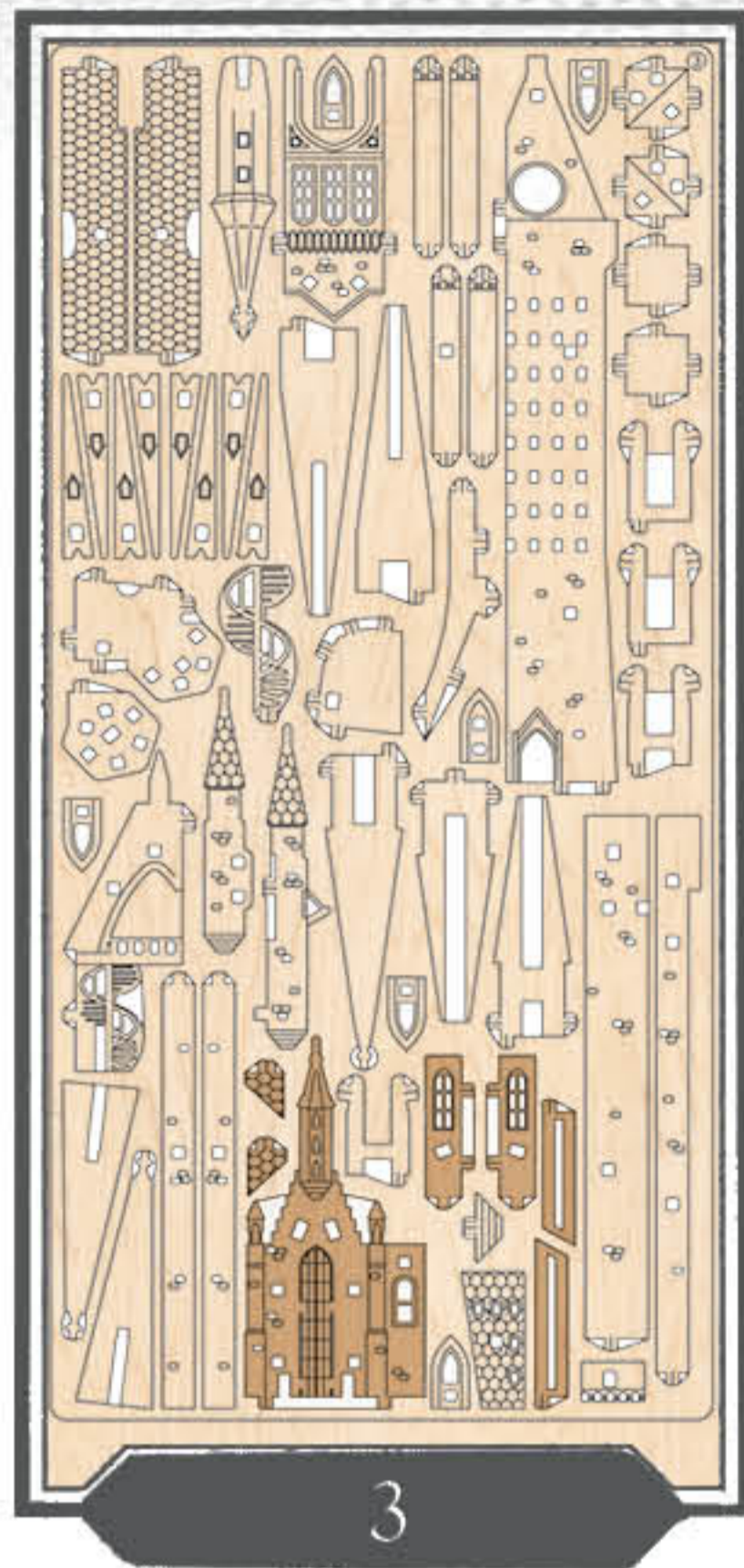

1

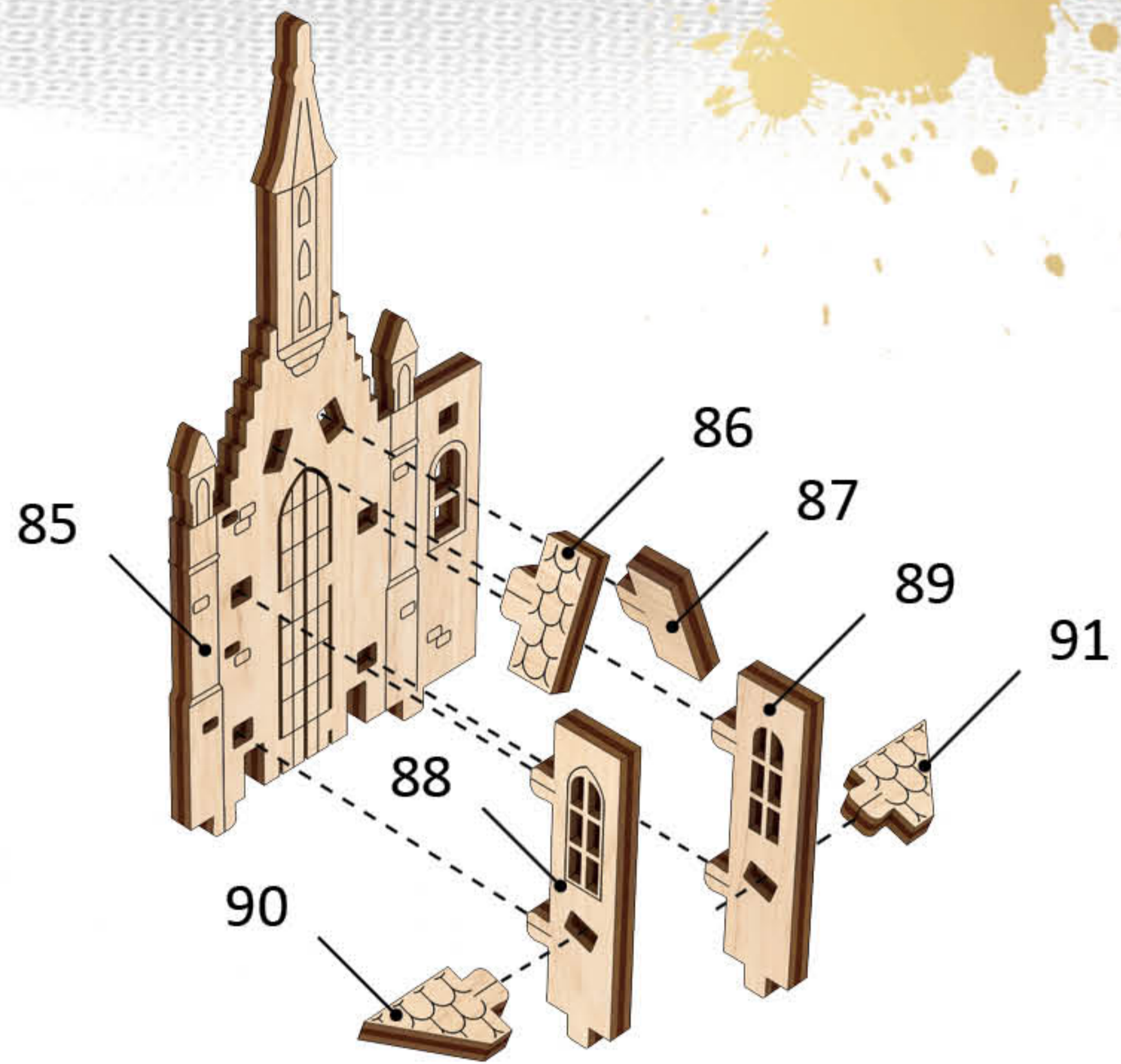

2

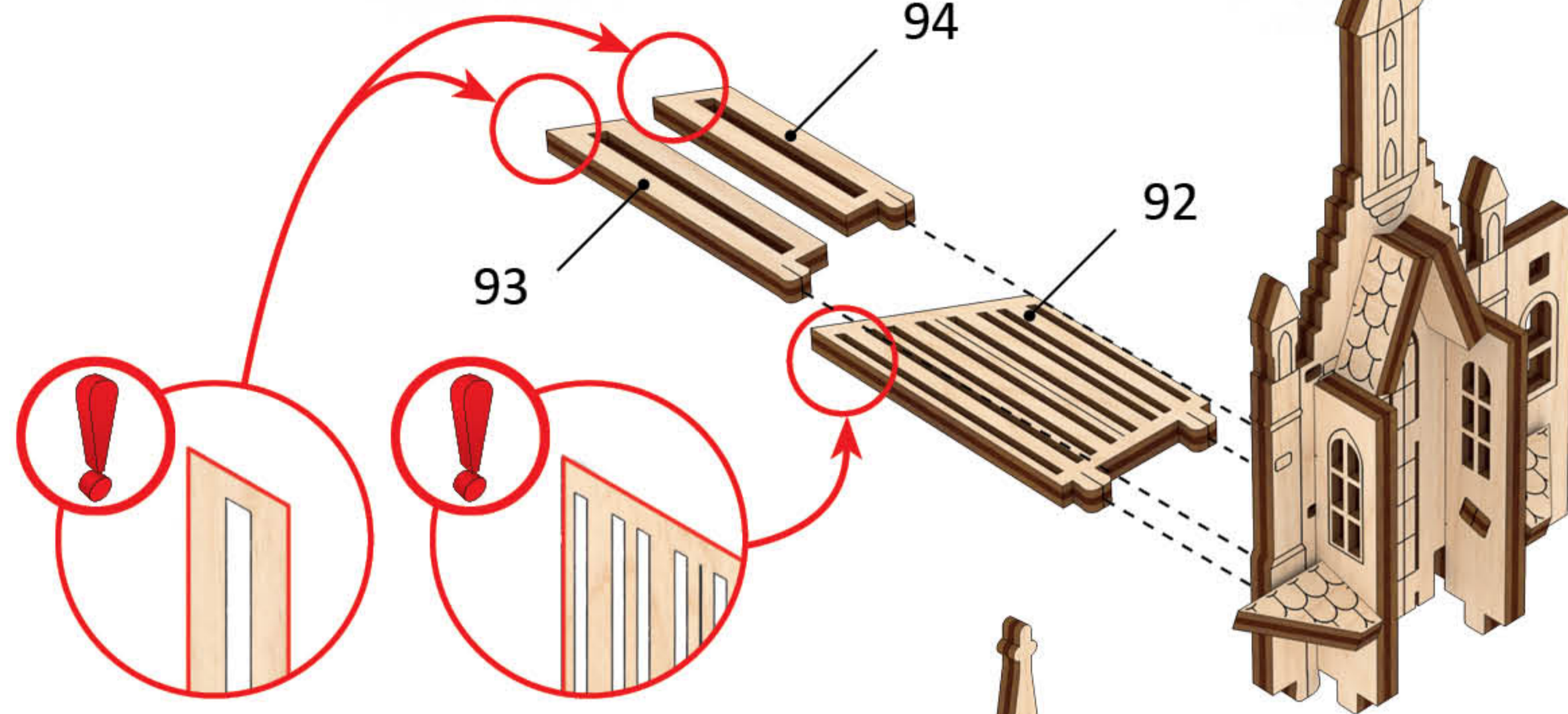

f1

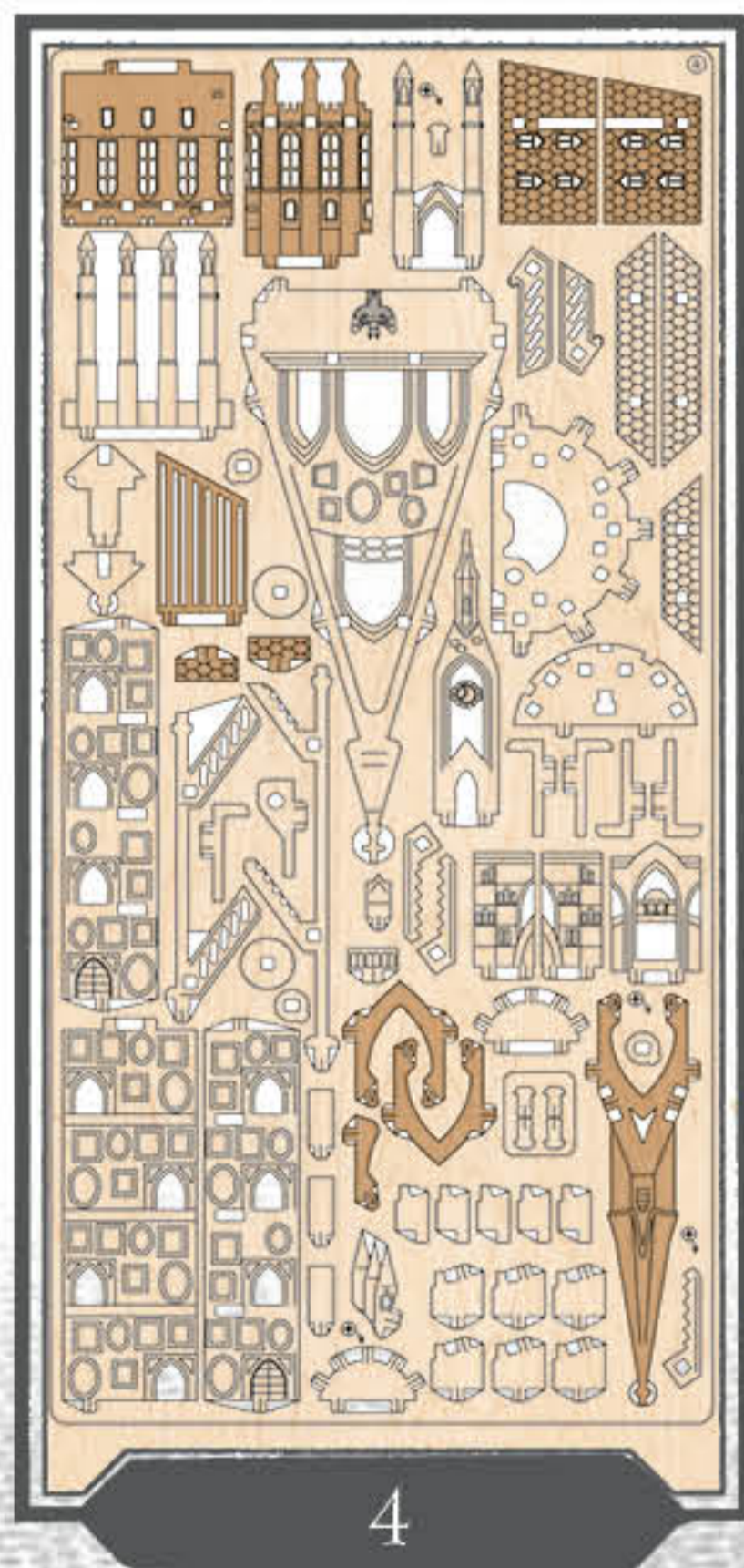
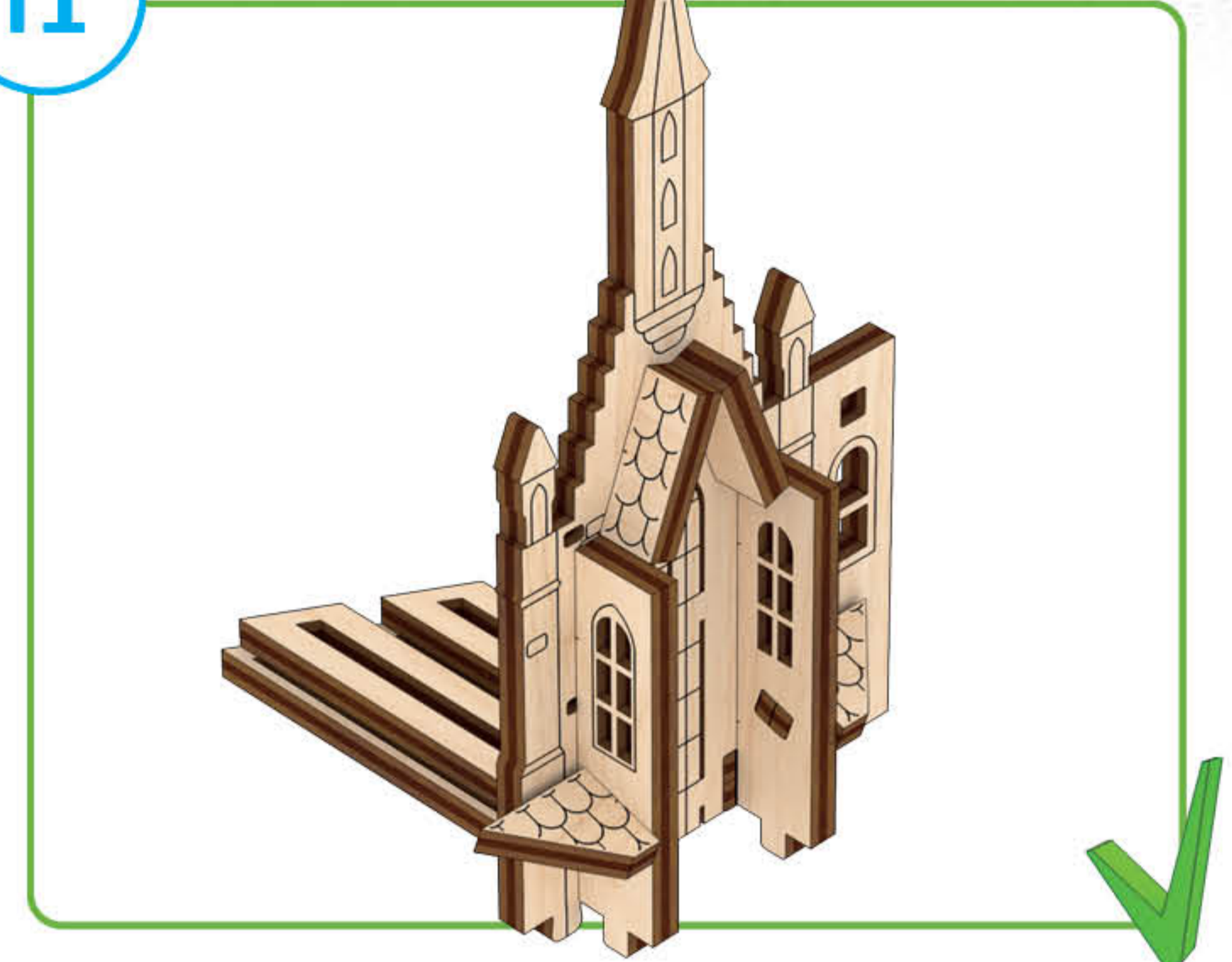

1

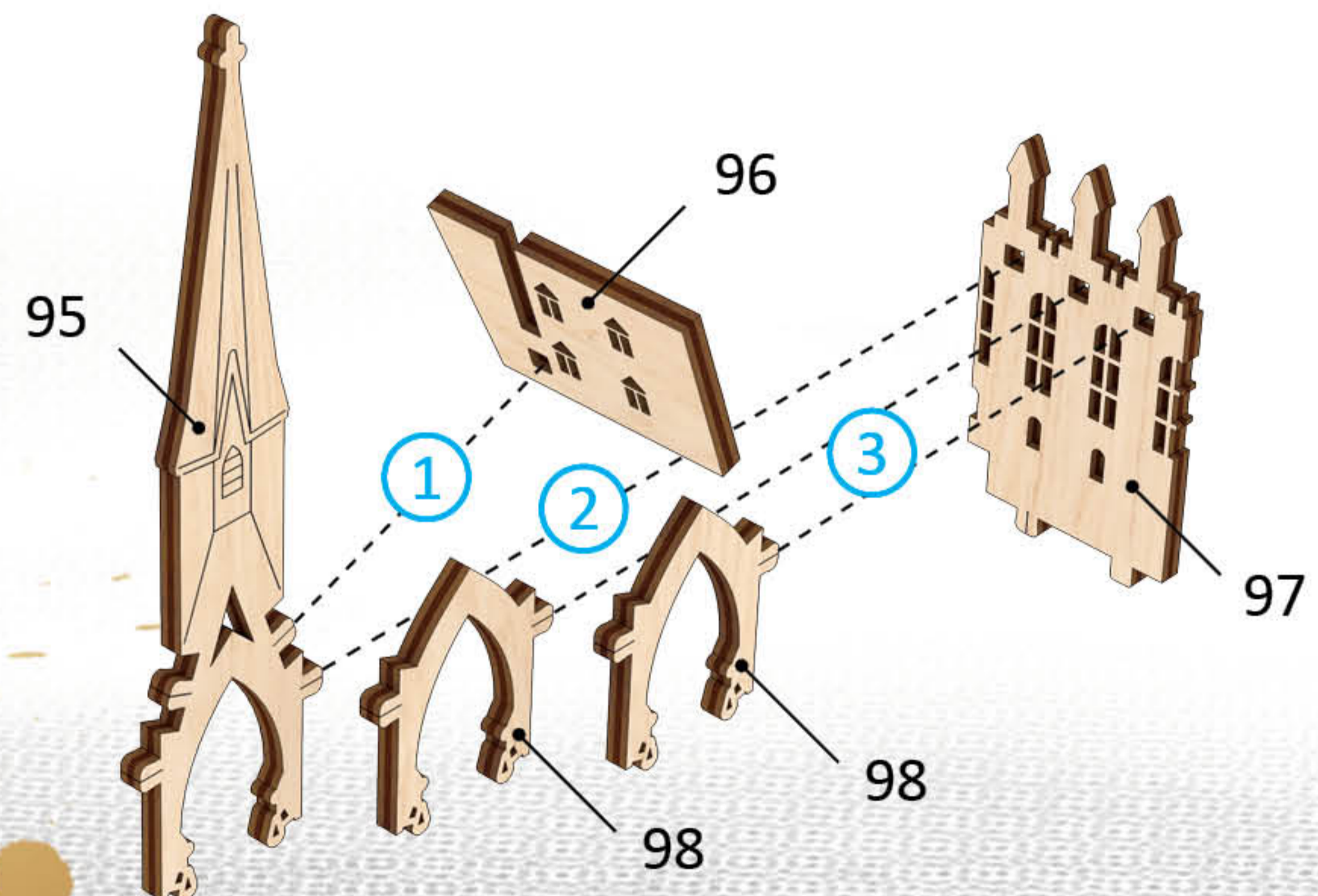

2

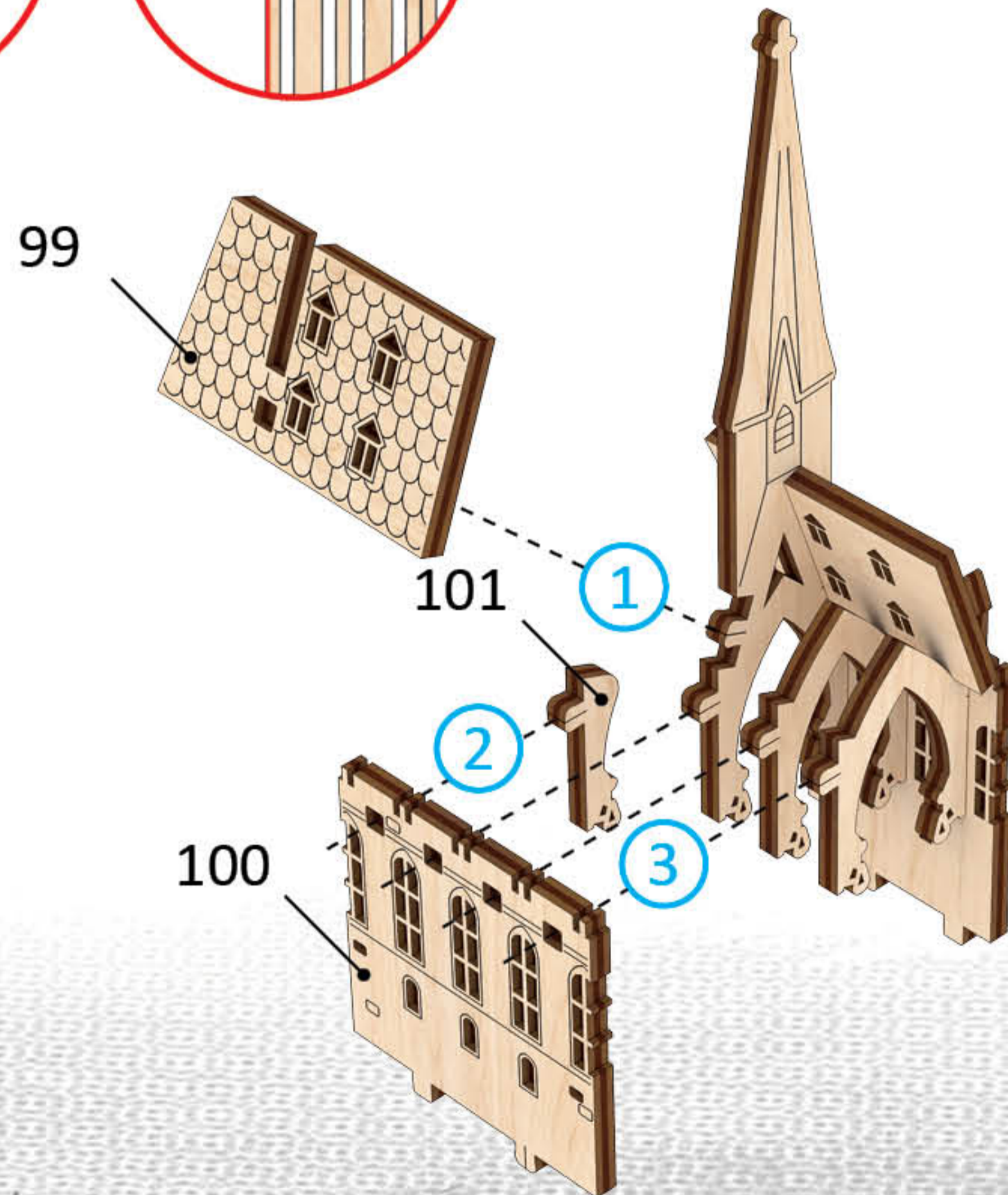

f2

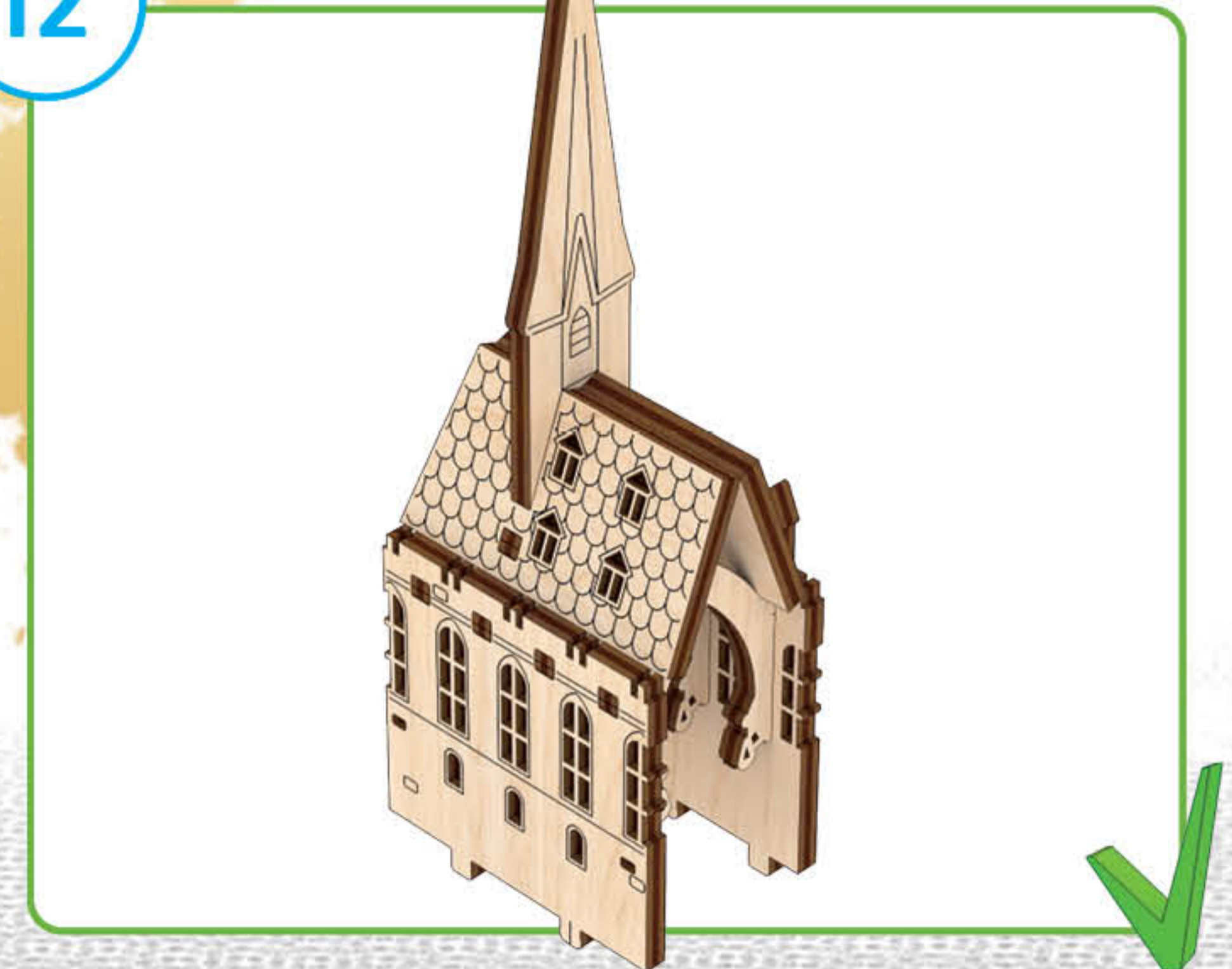

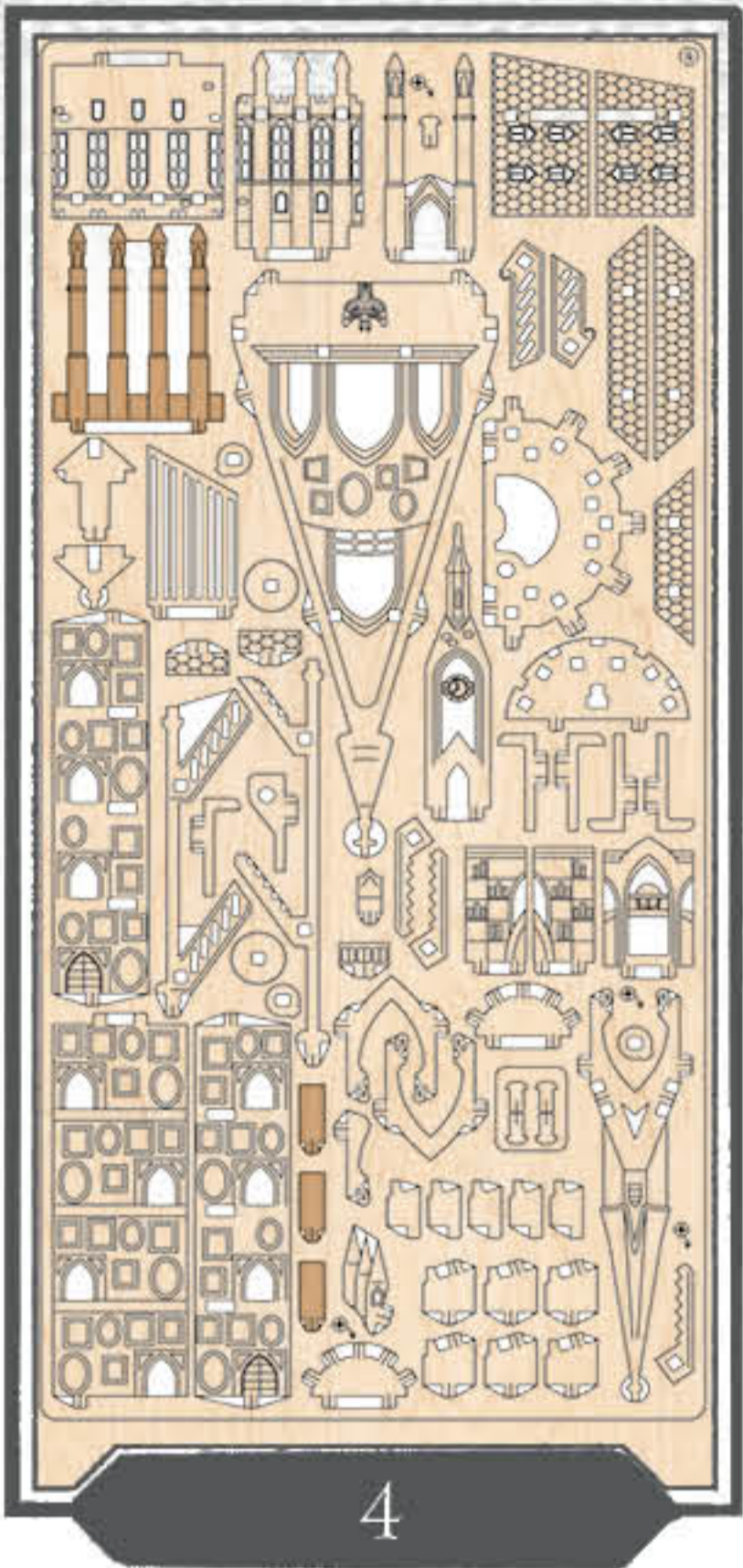

1

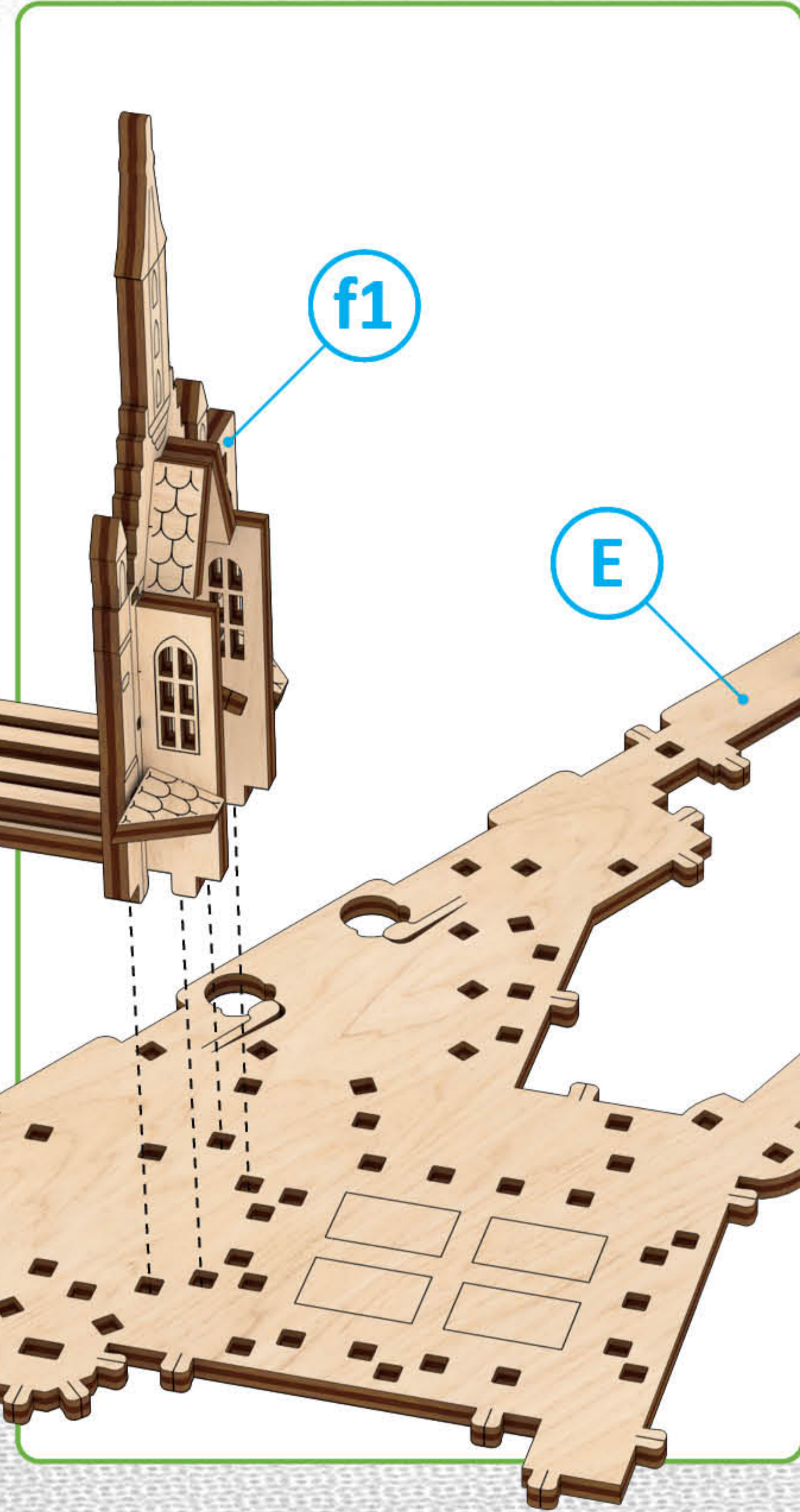

2

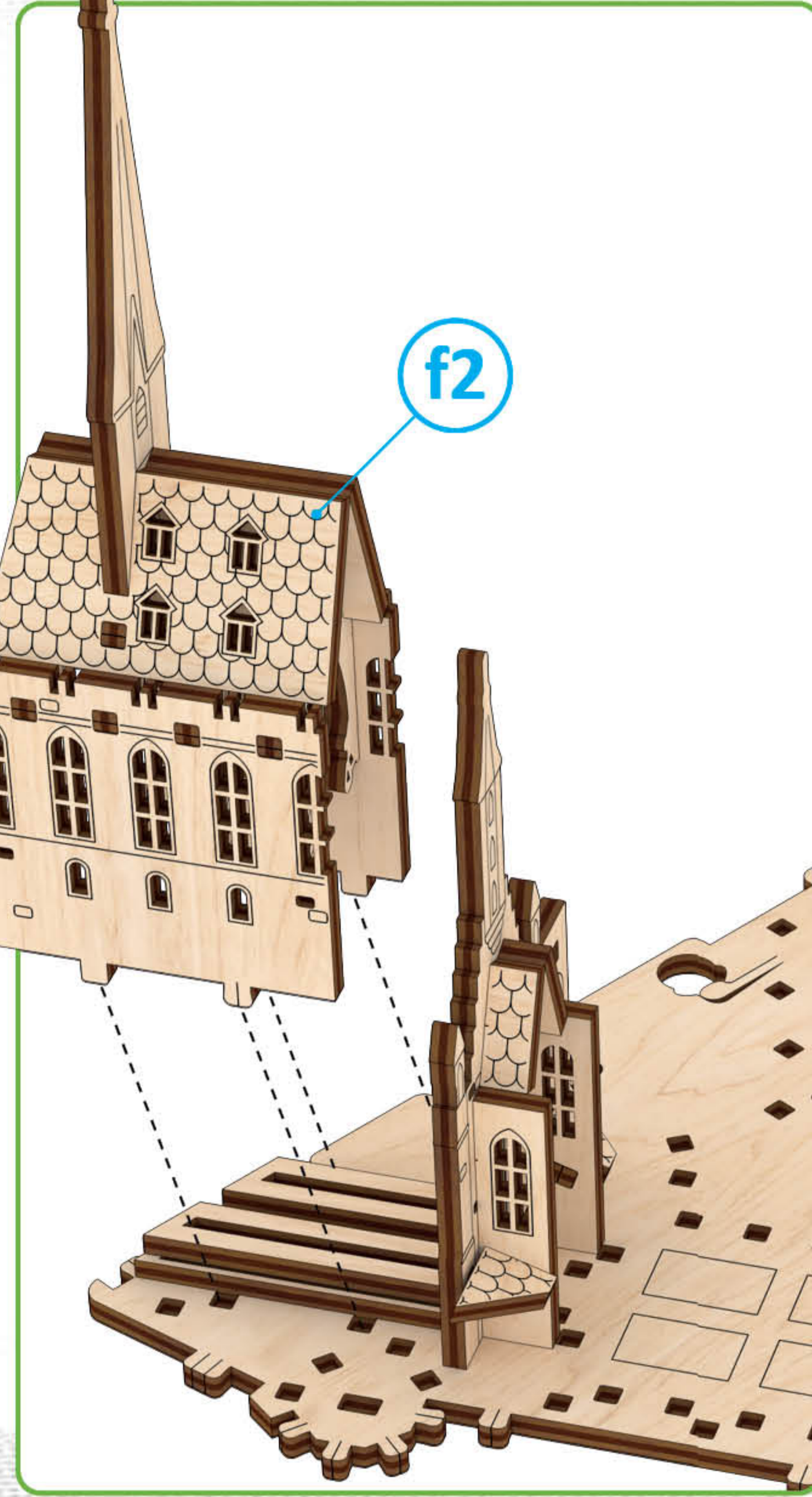

3

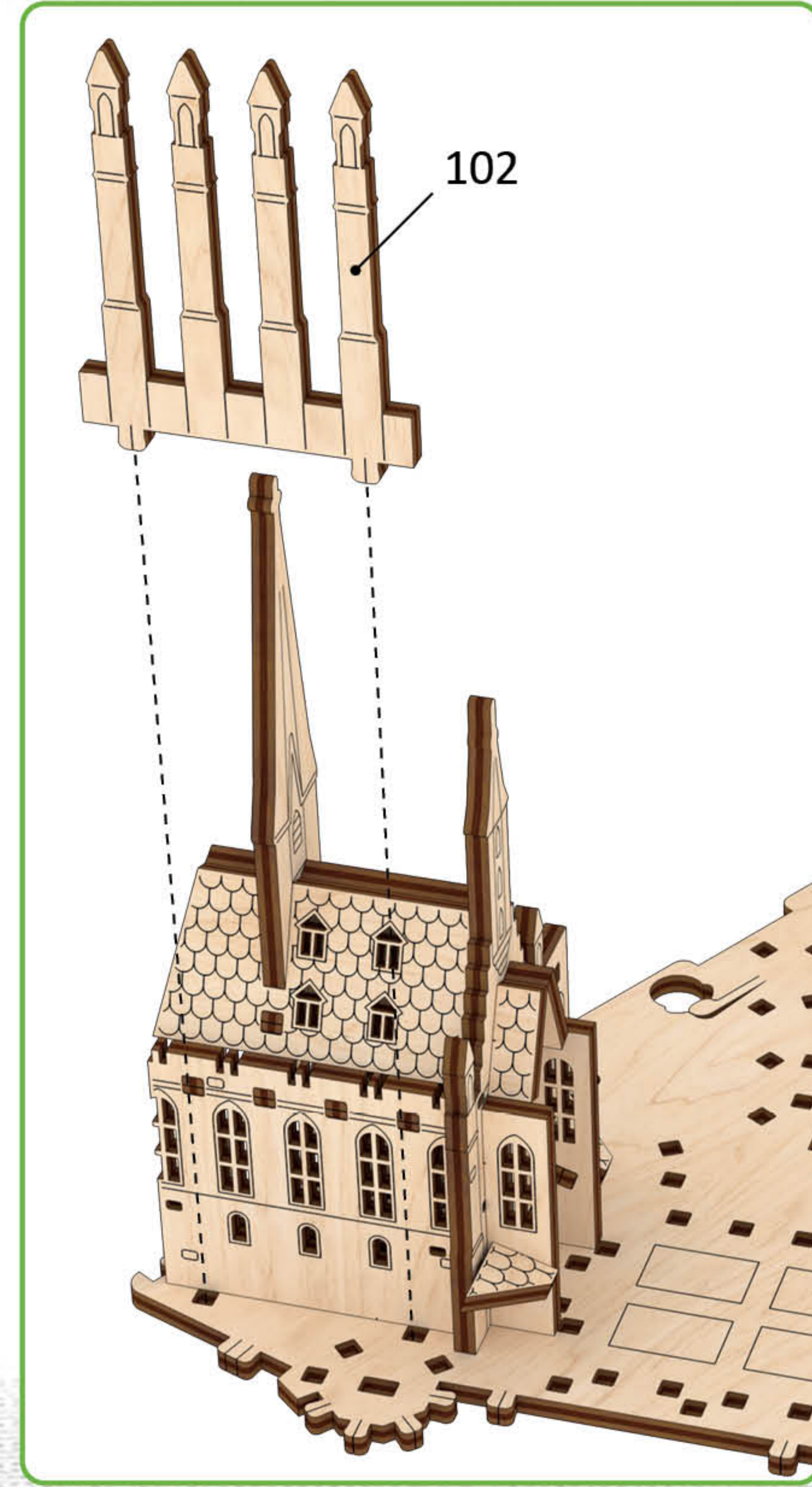

4

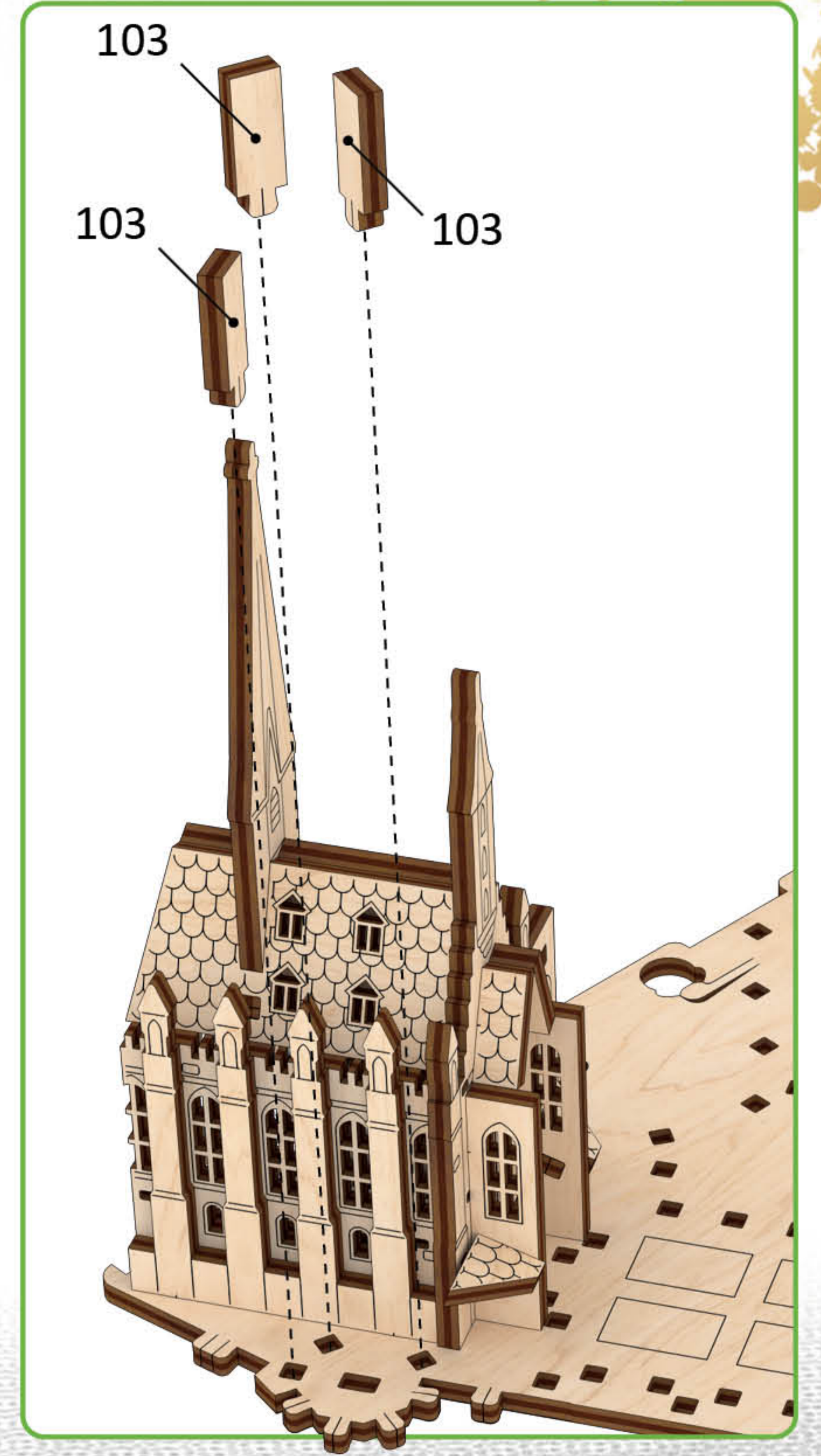

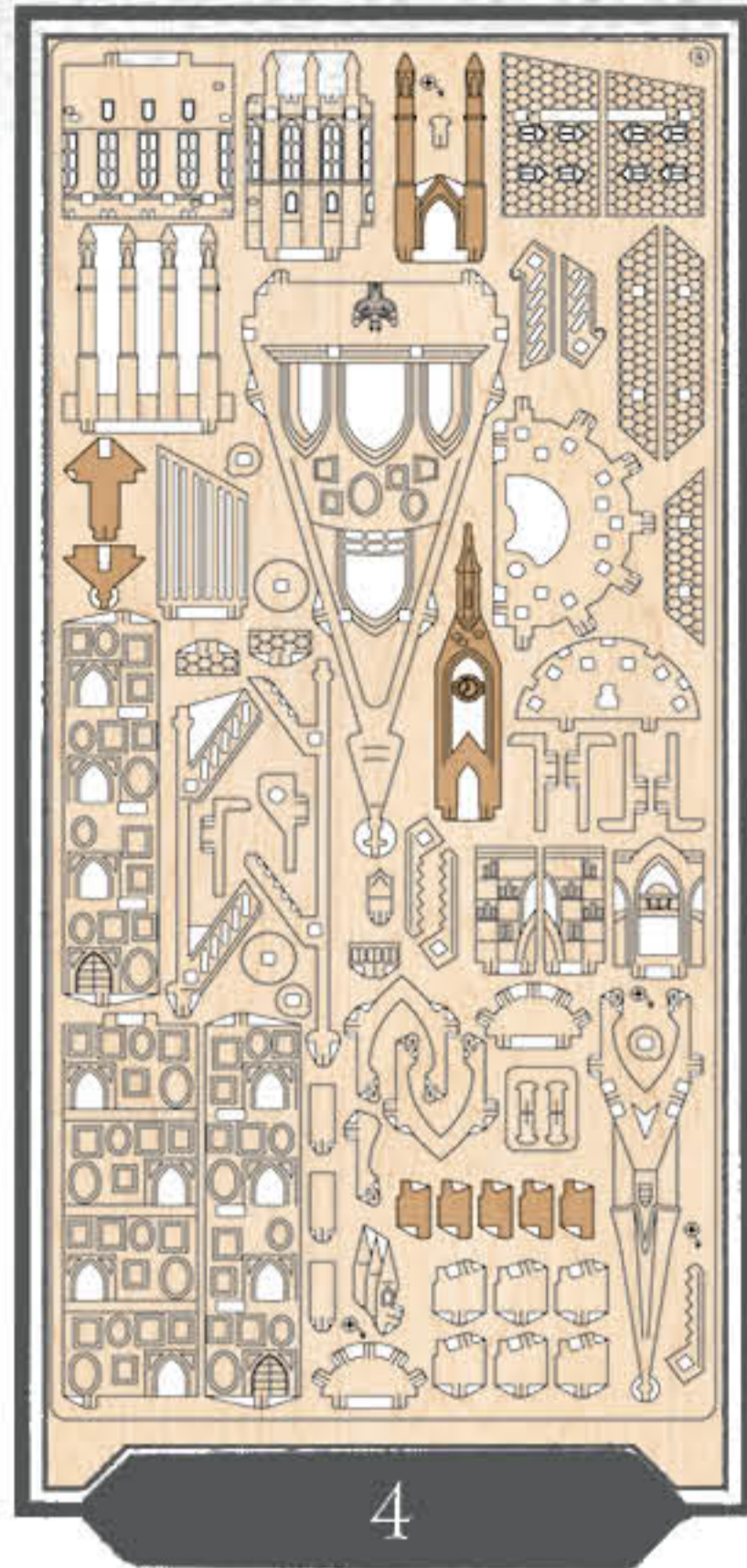

5

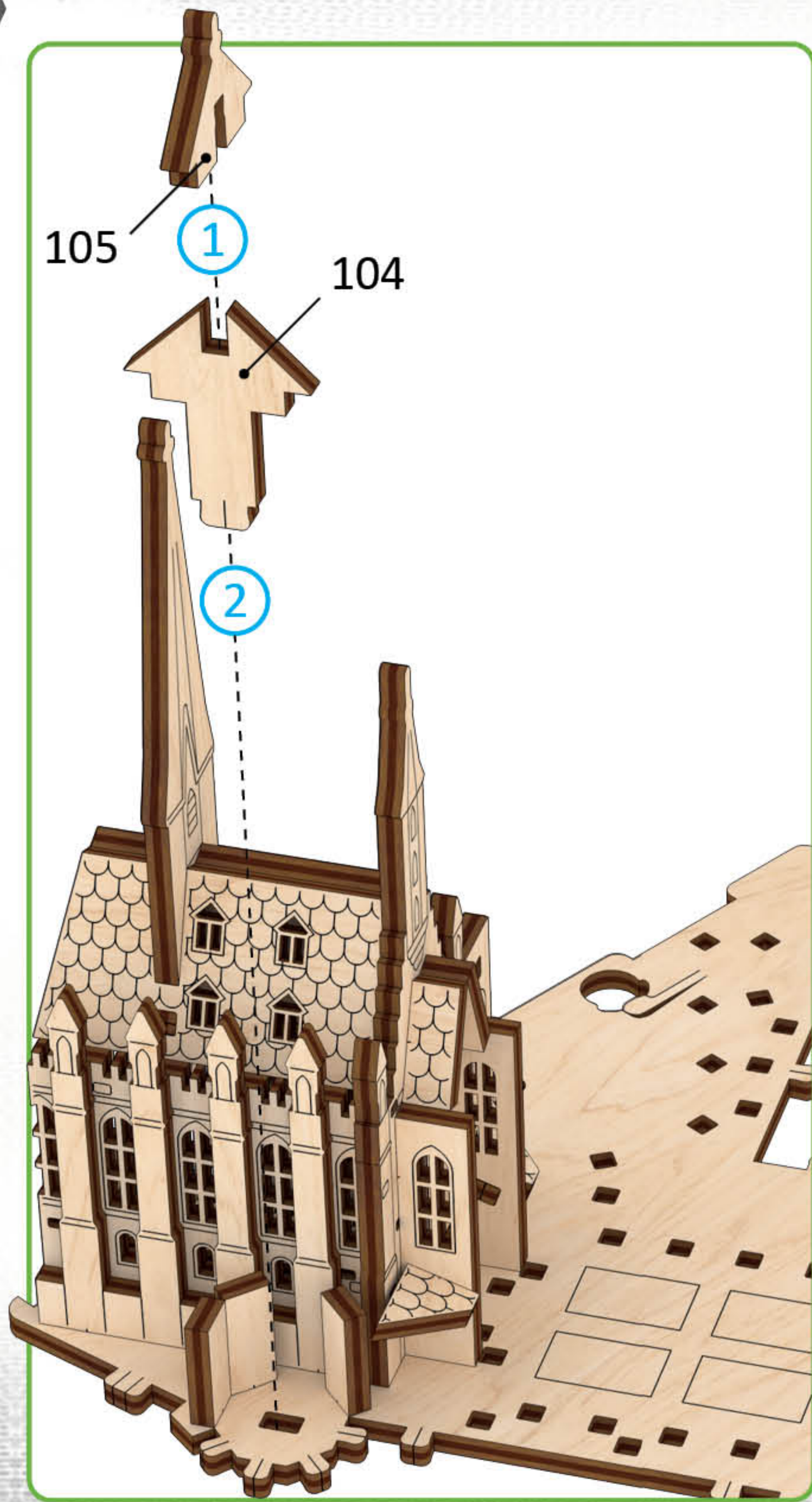

5

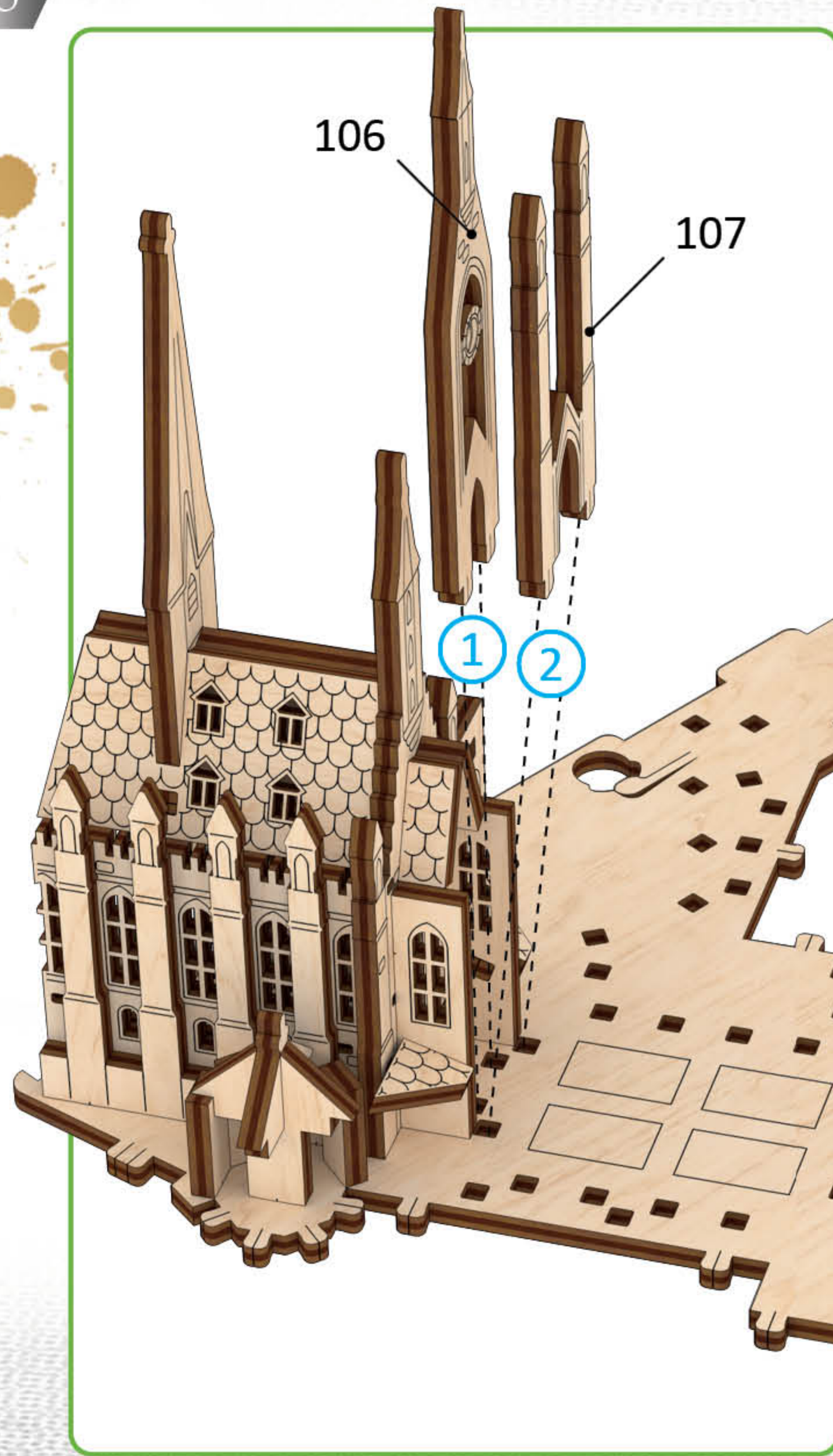

7

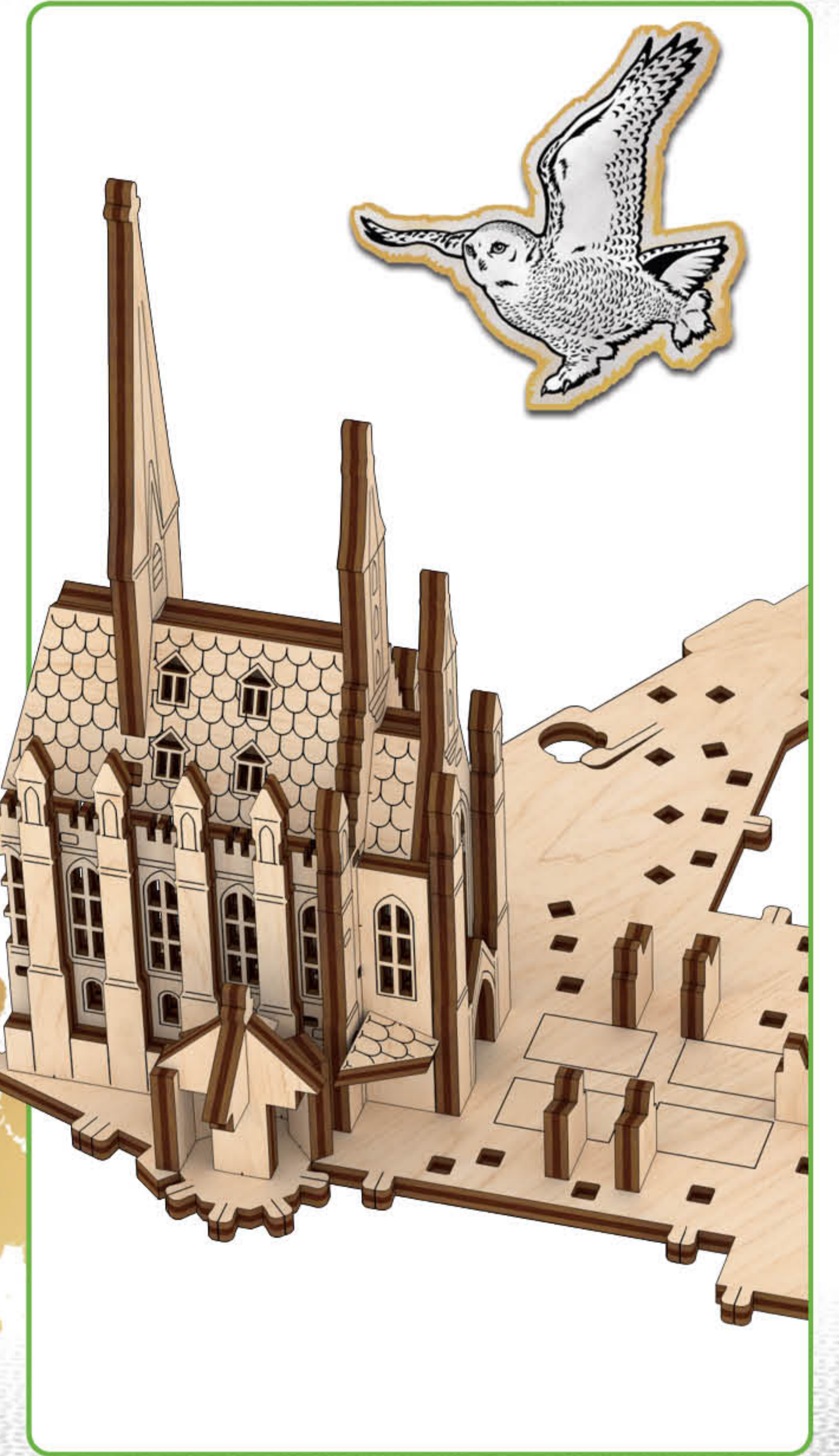
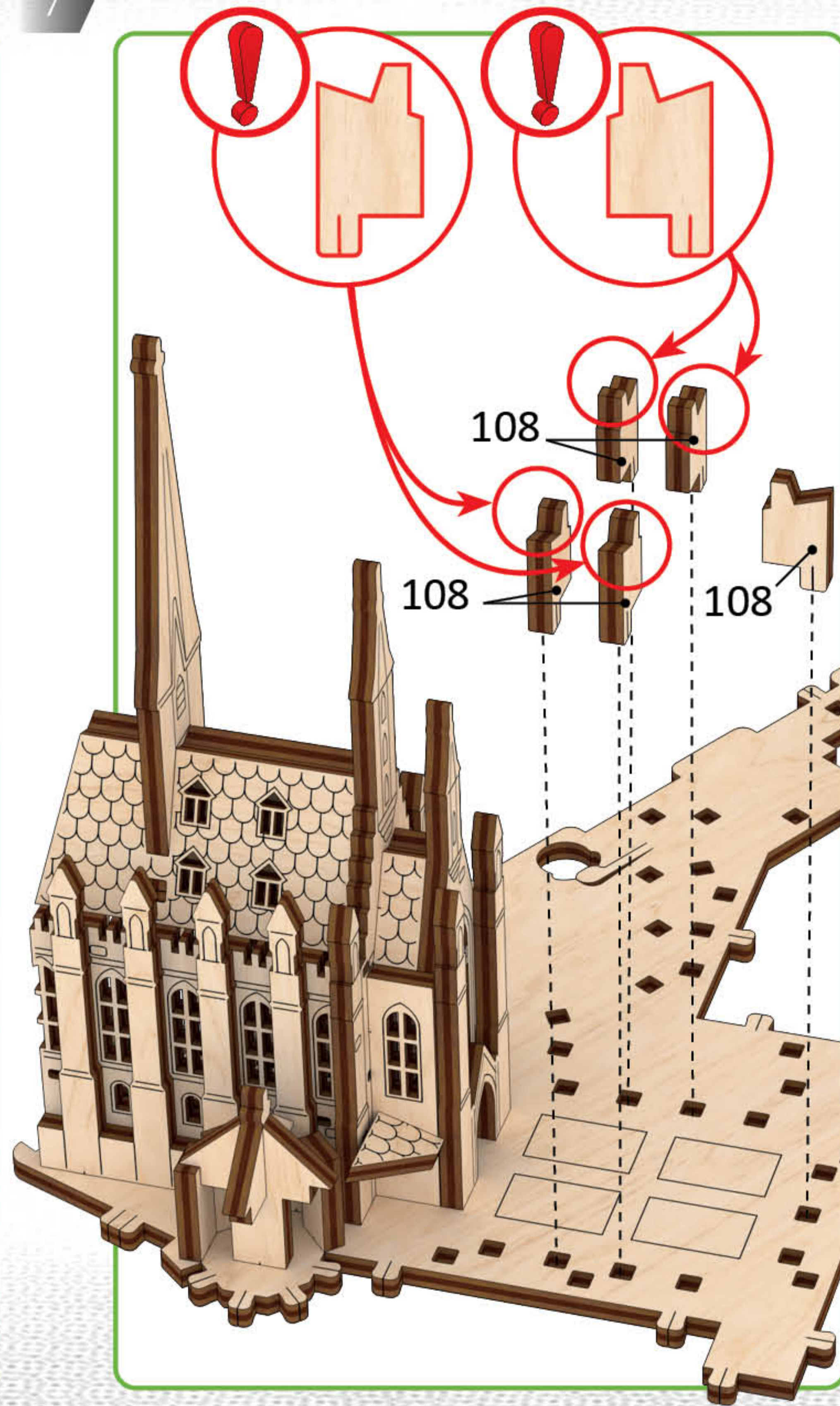

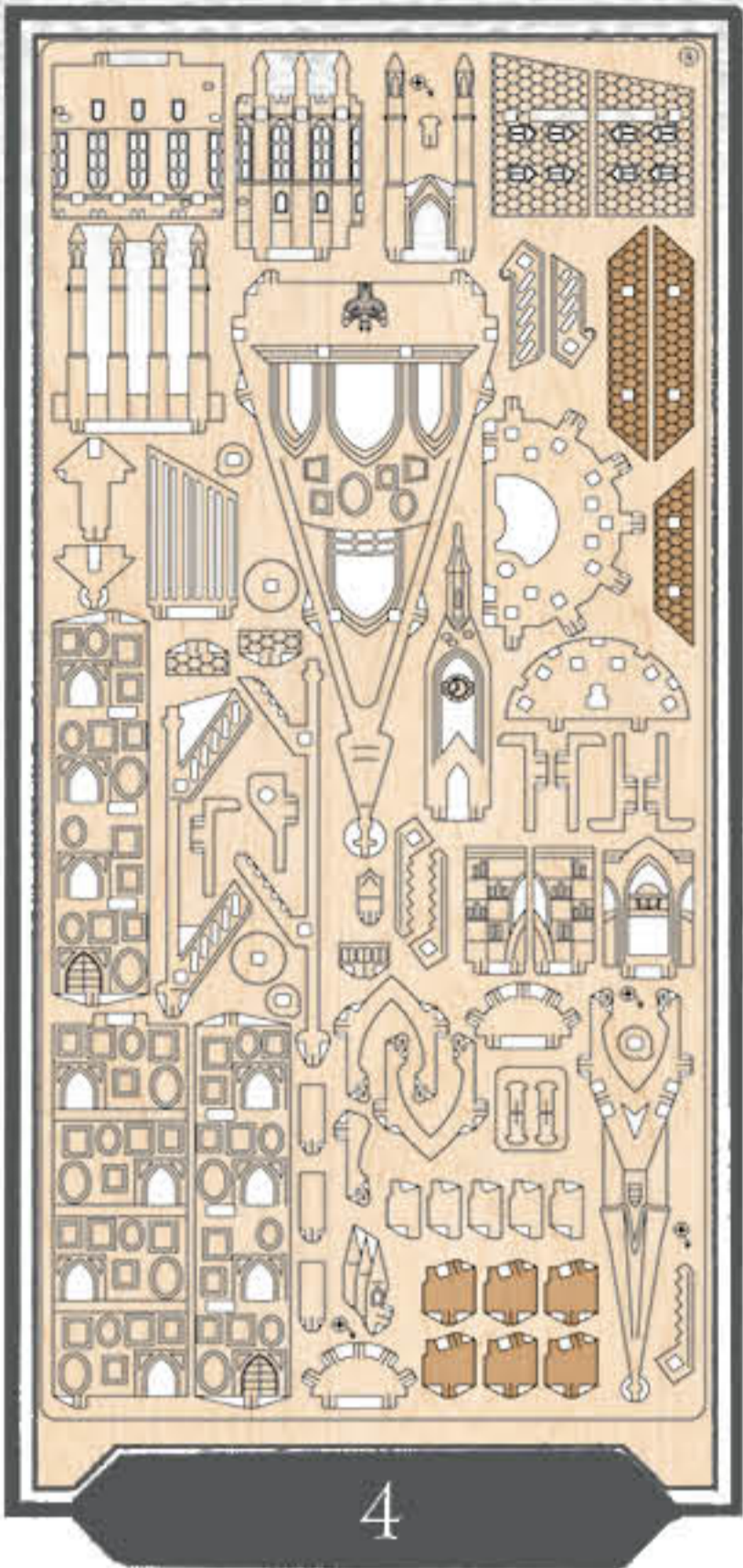

8

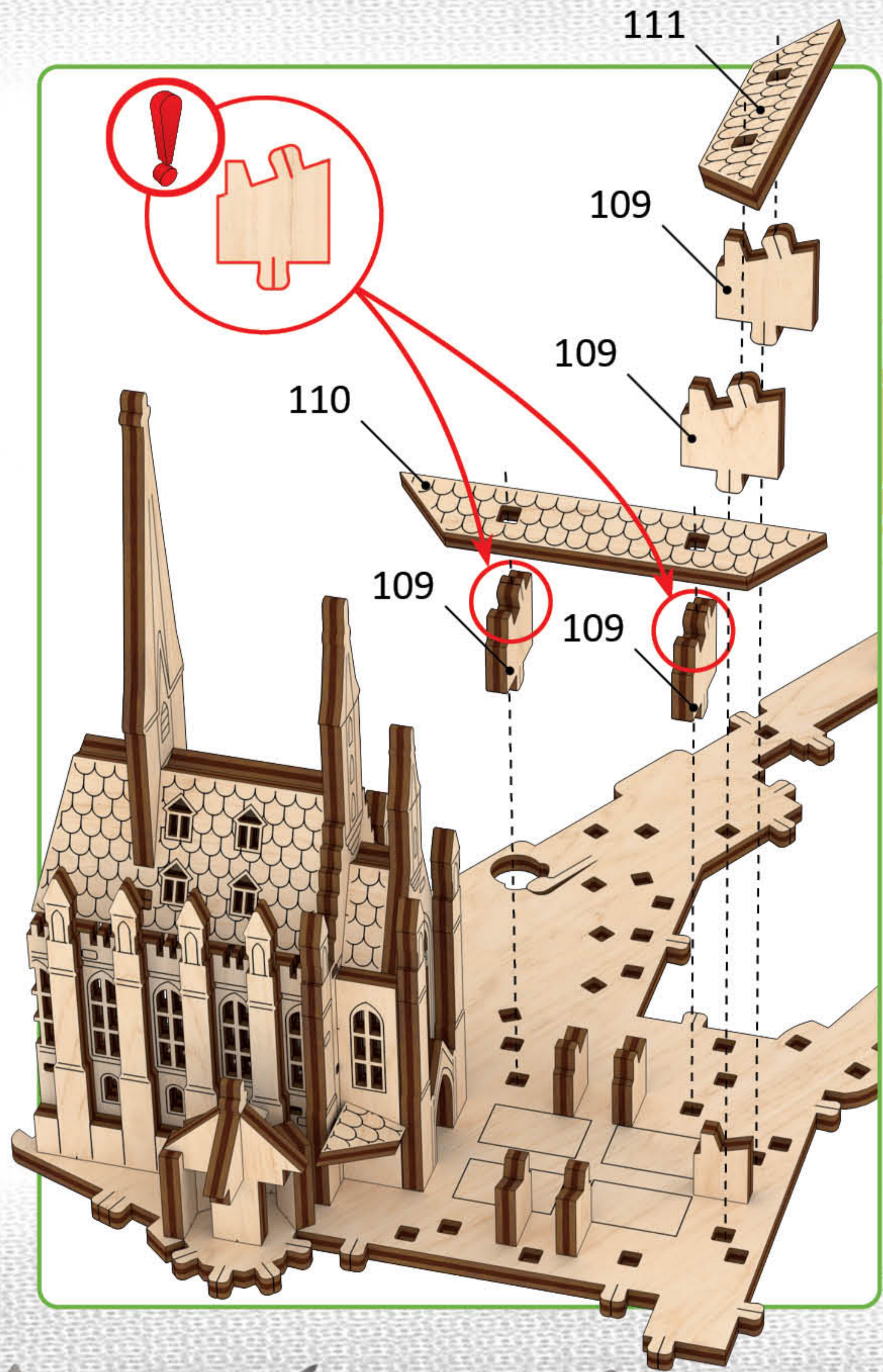

9

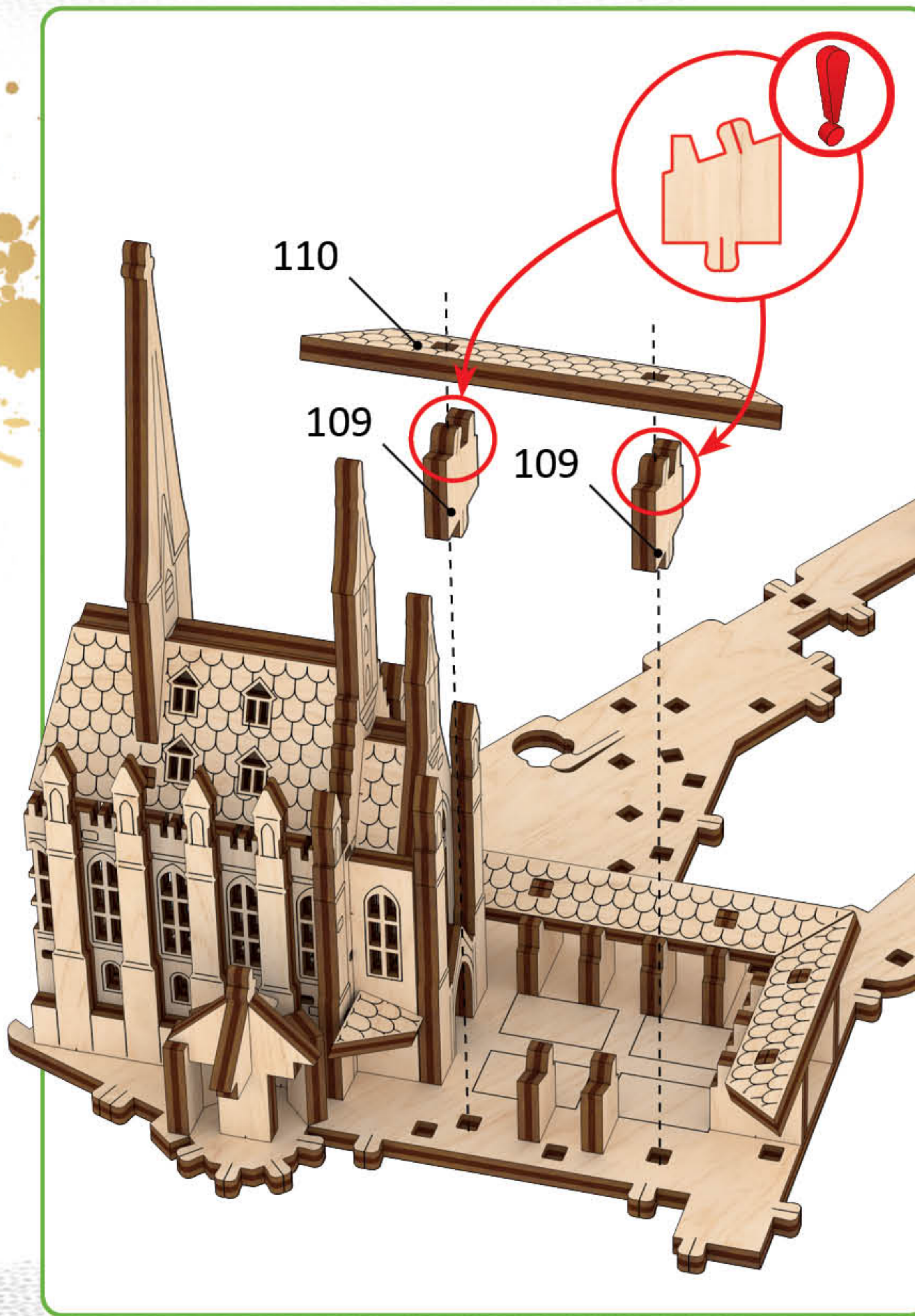

F

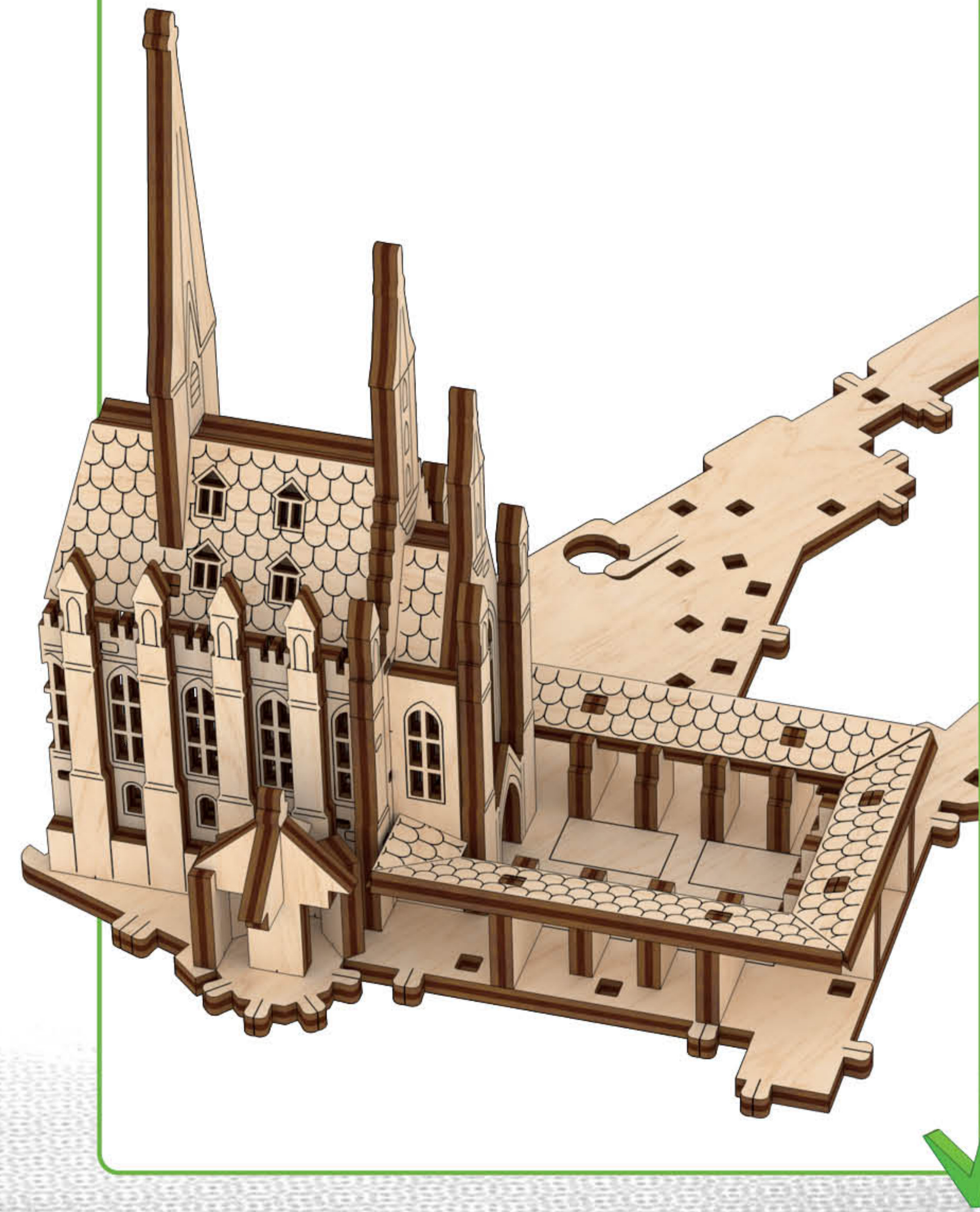

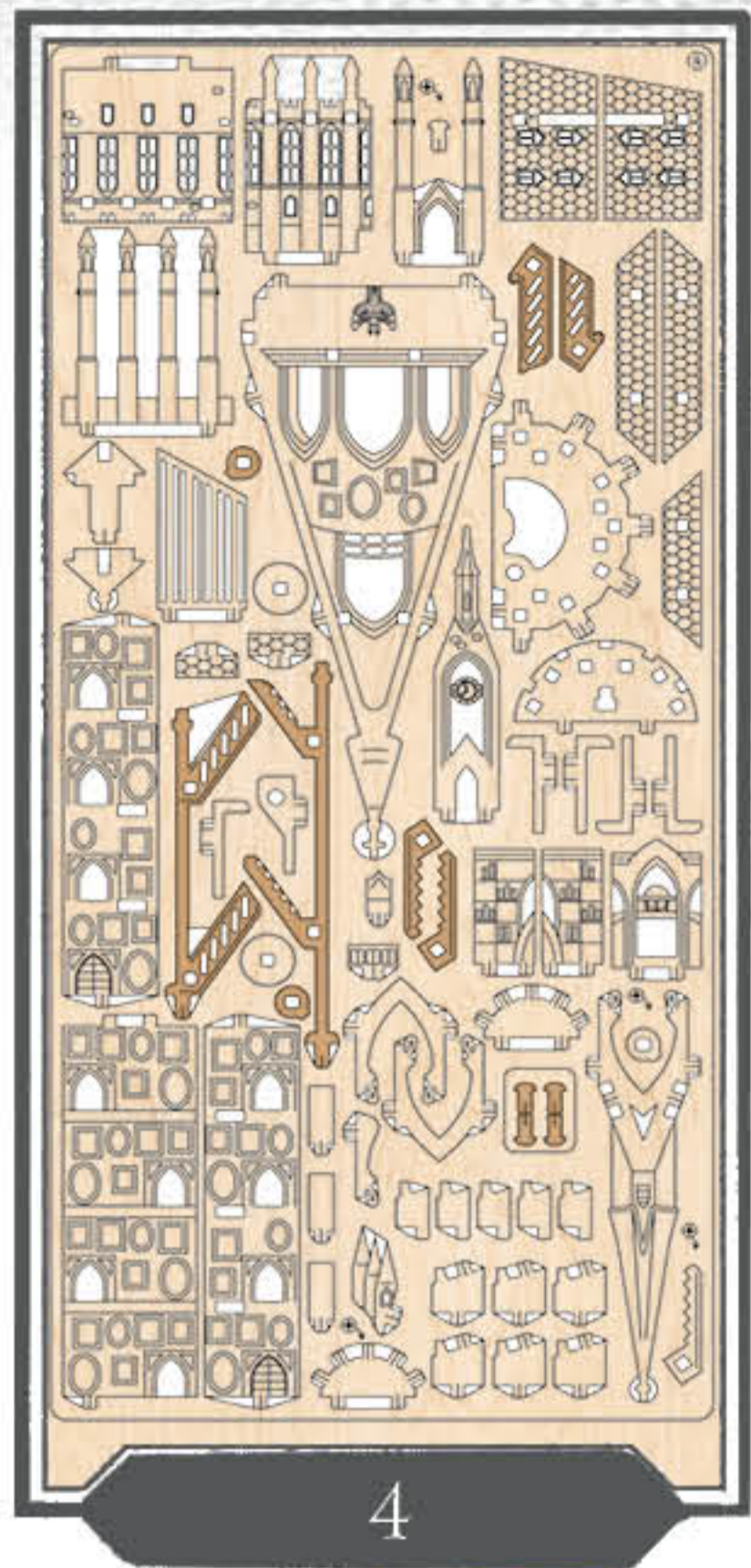

I

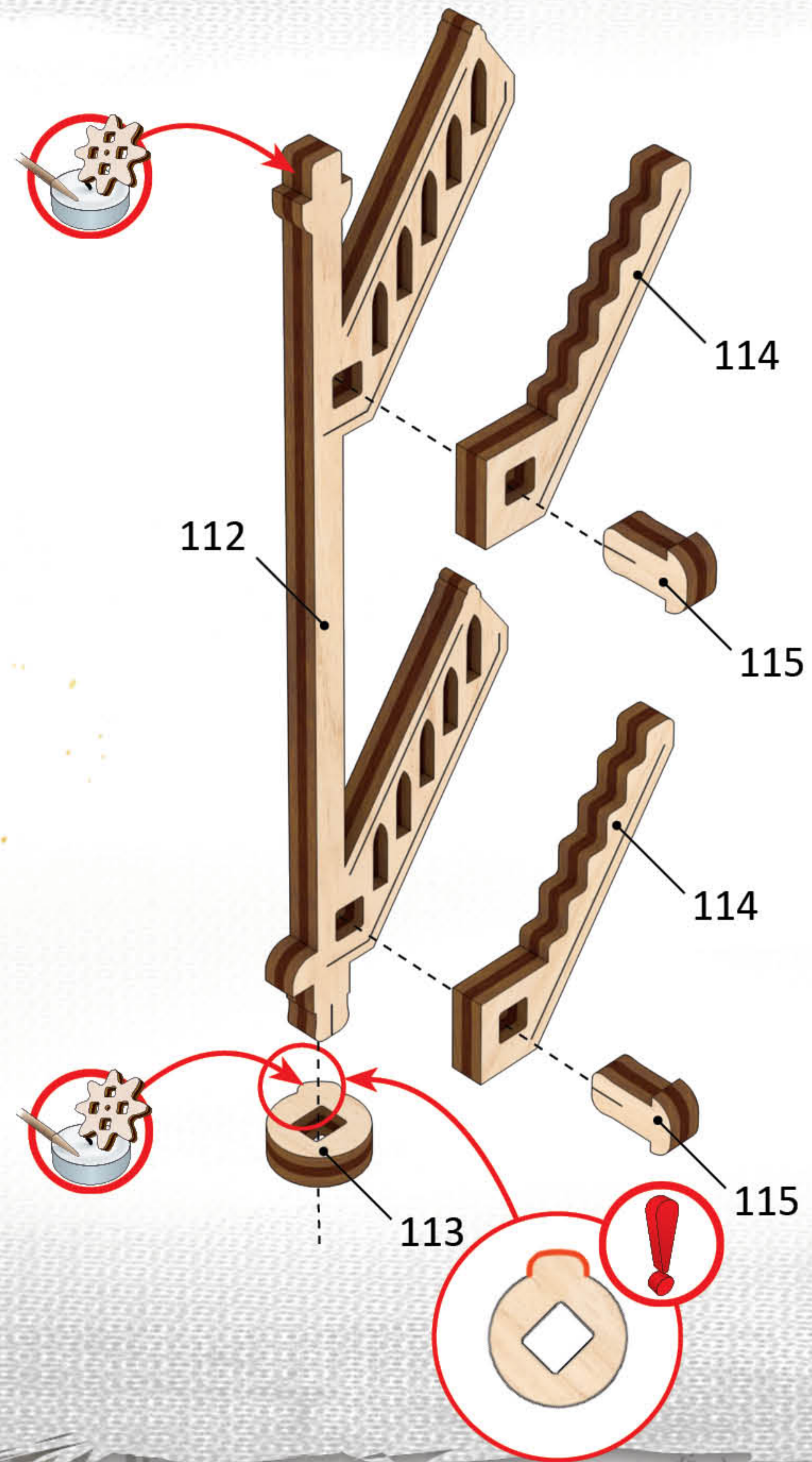

g1

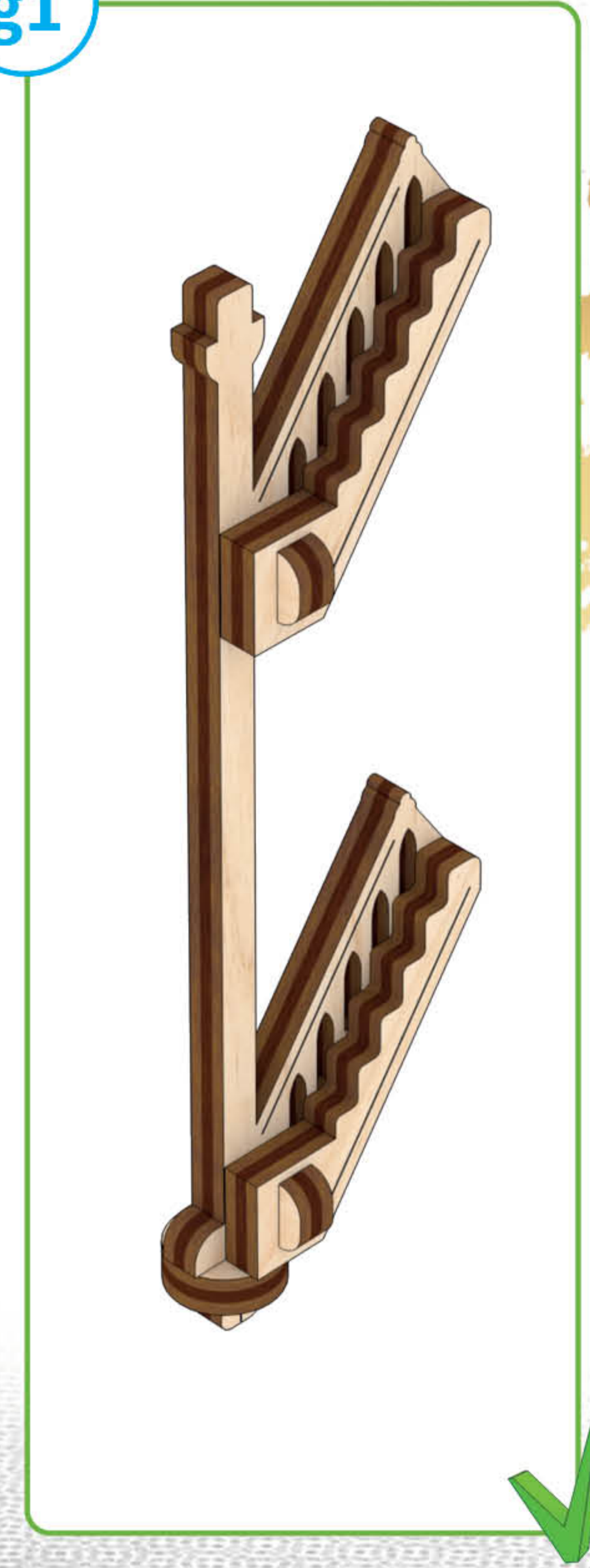

I

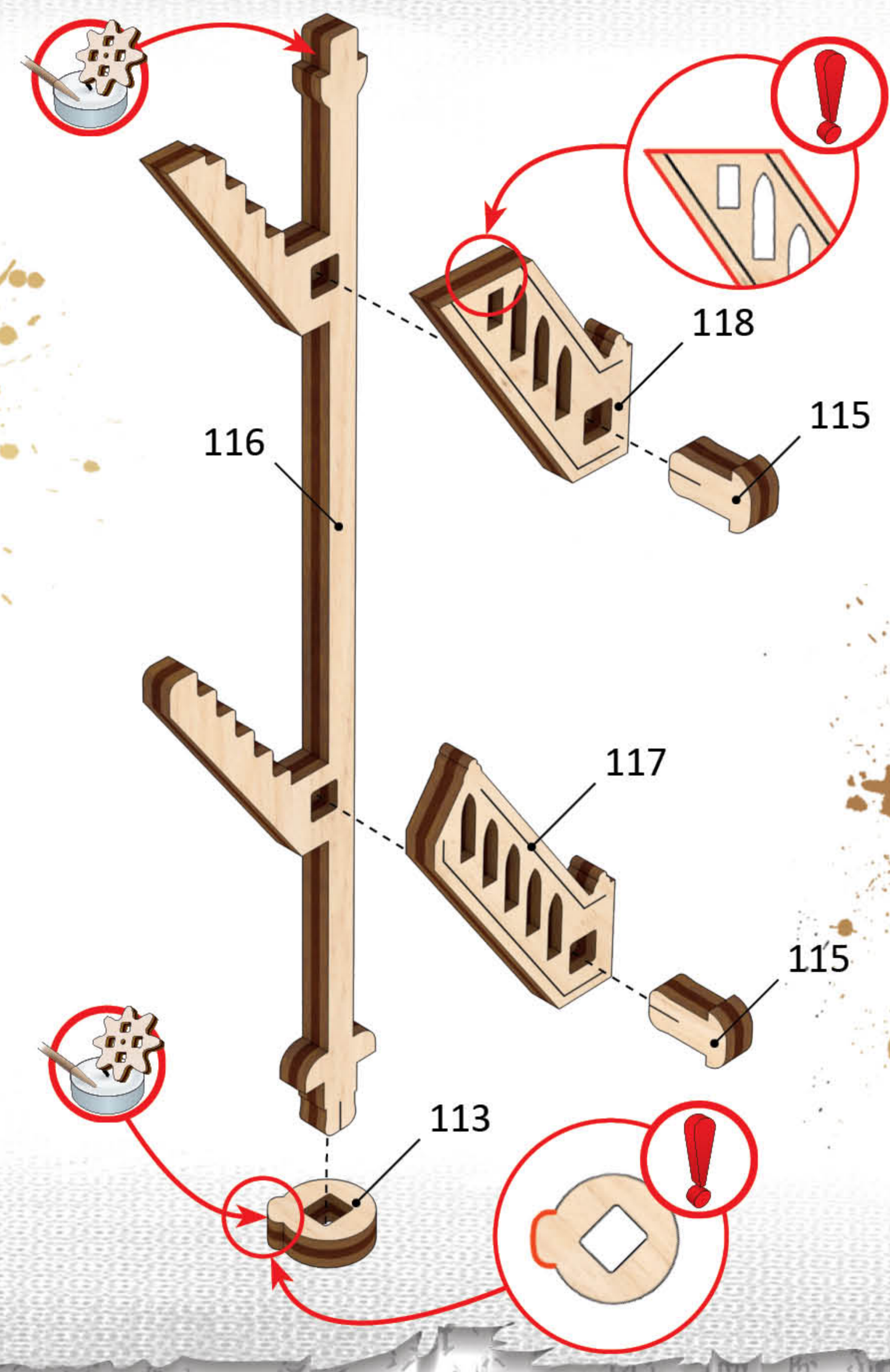

g2

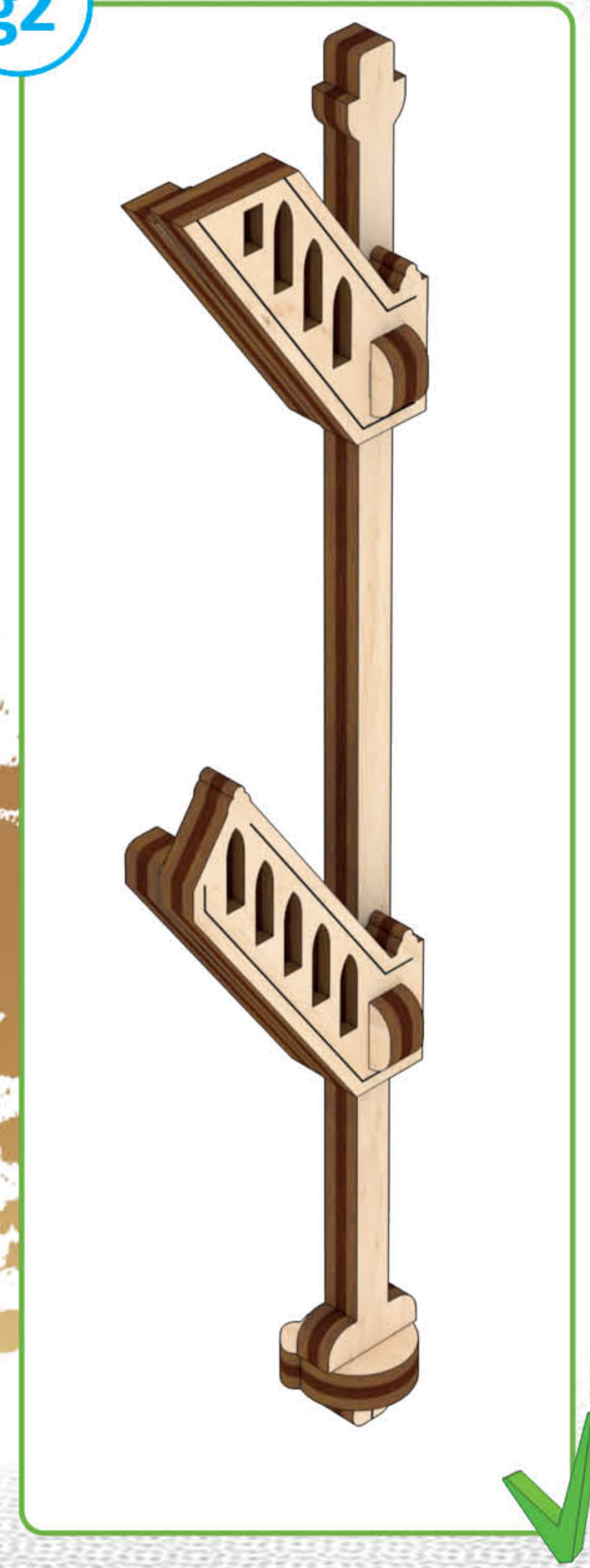

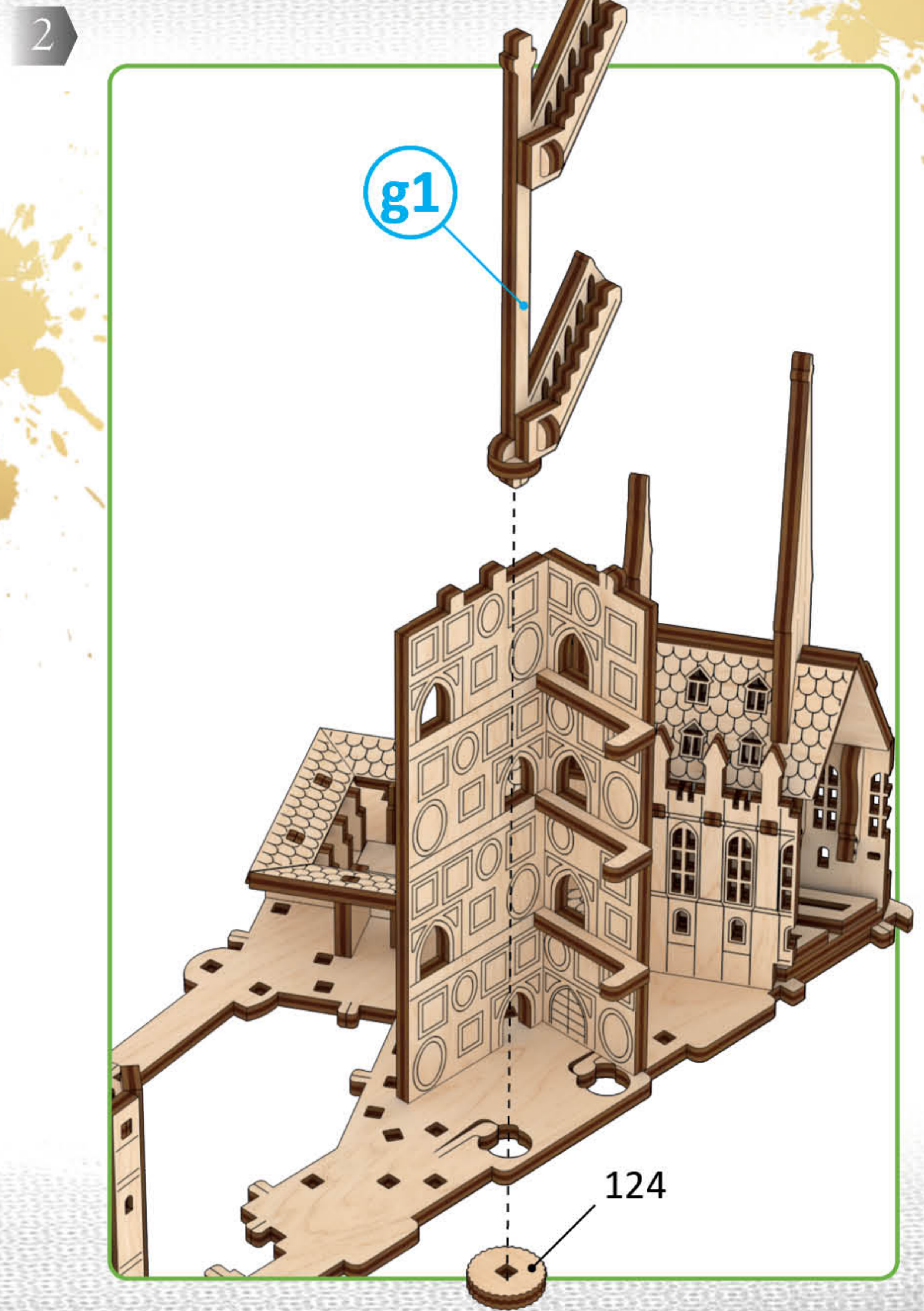
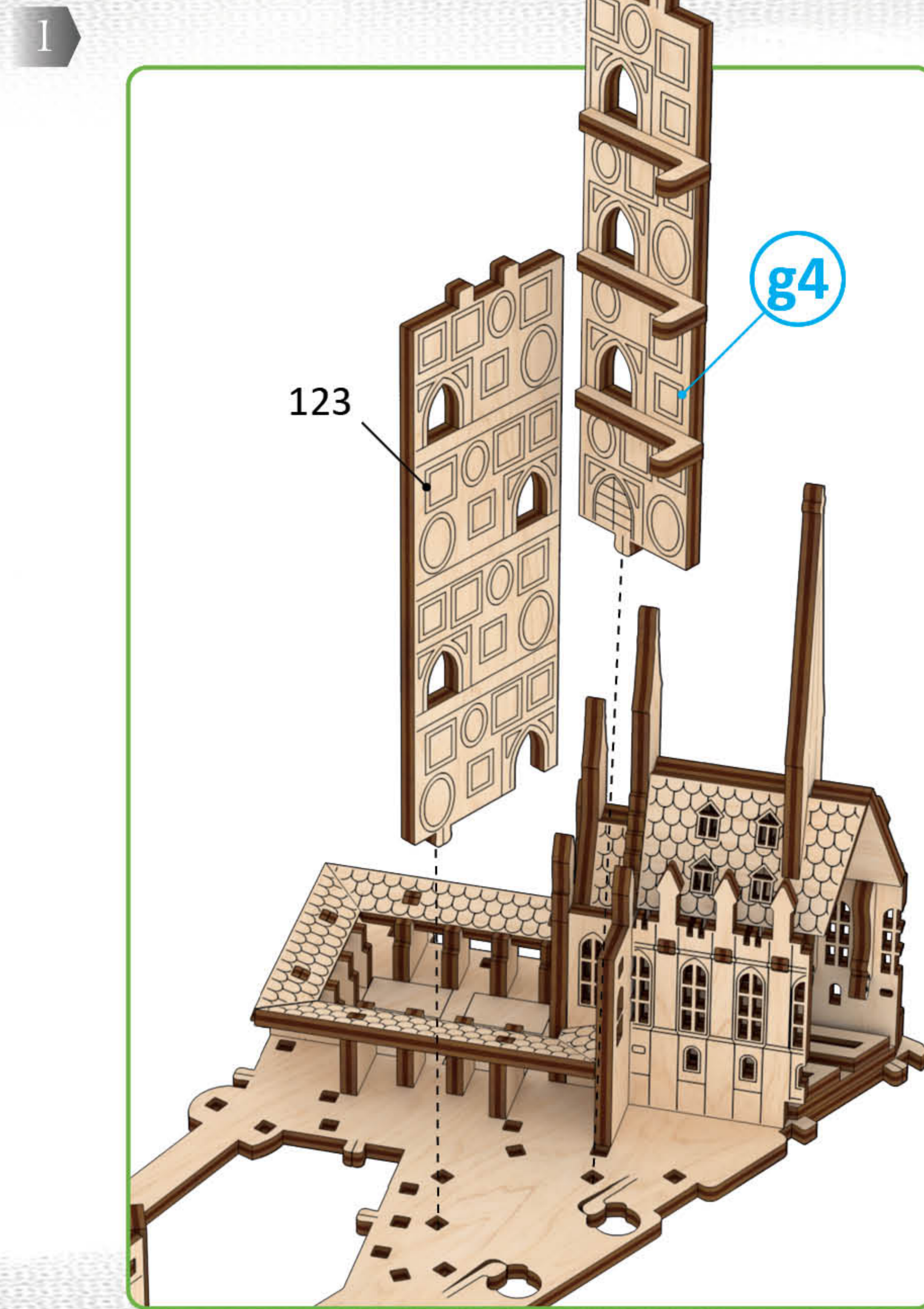
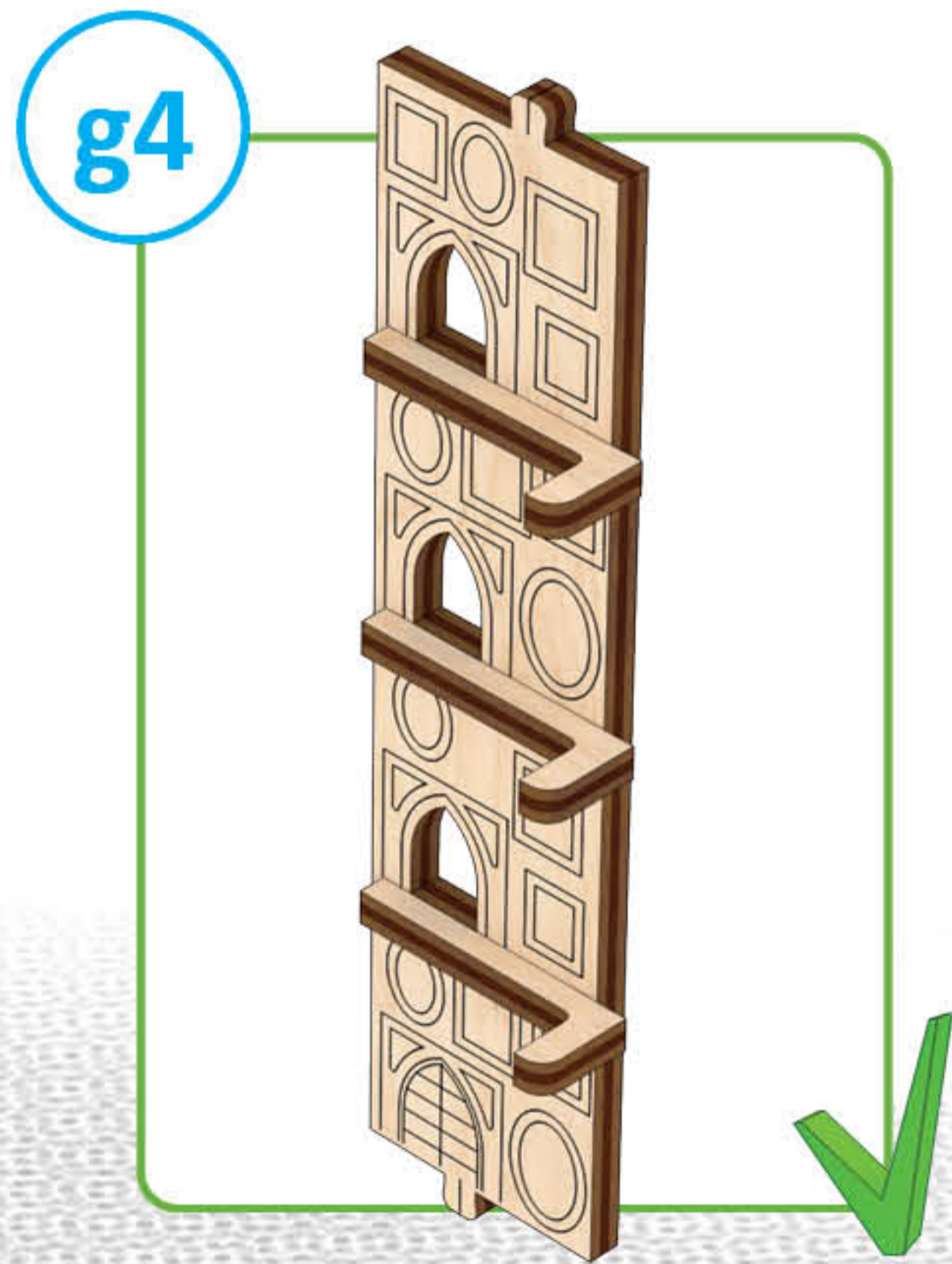
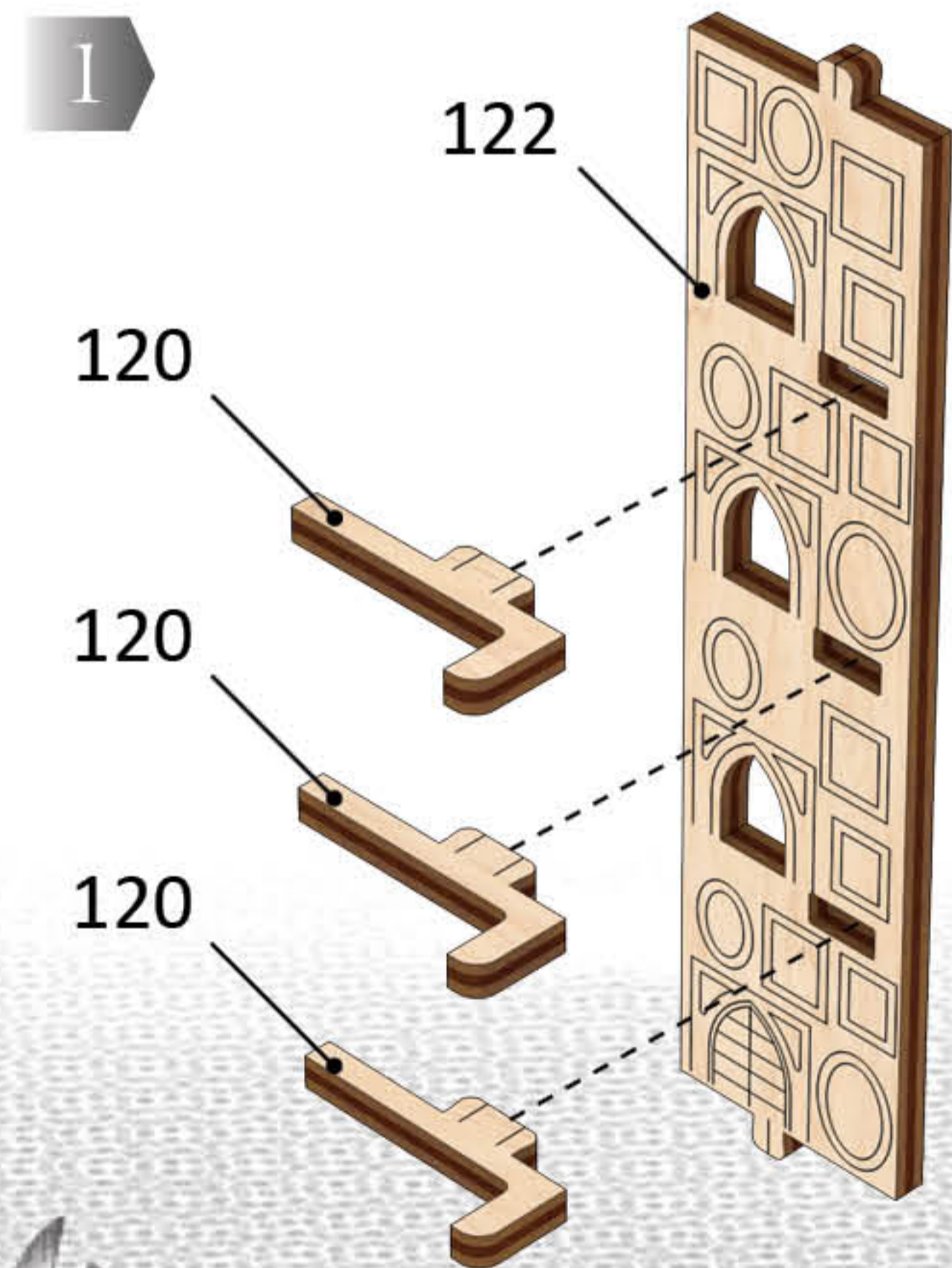
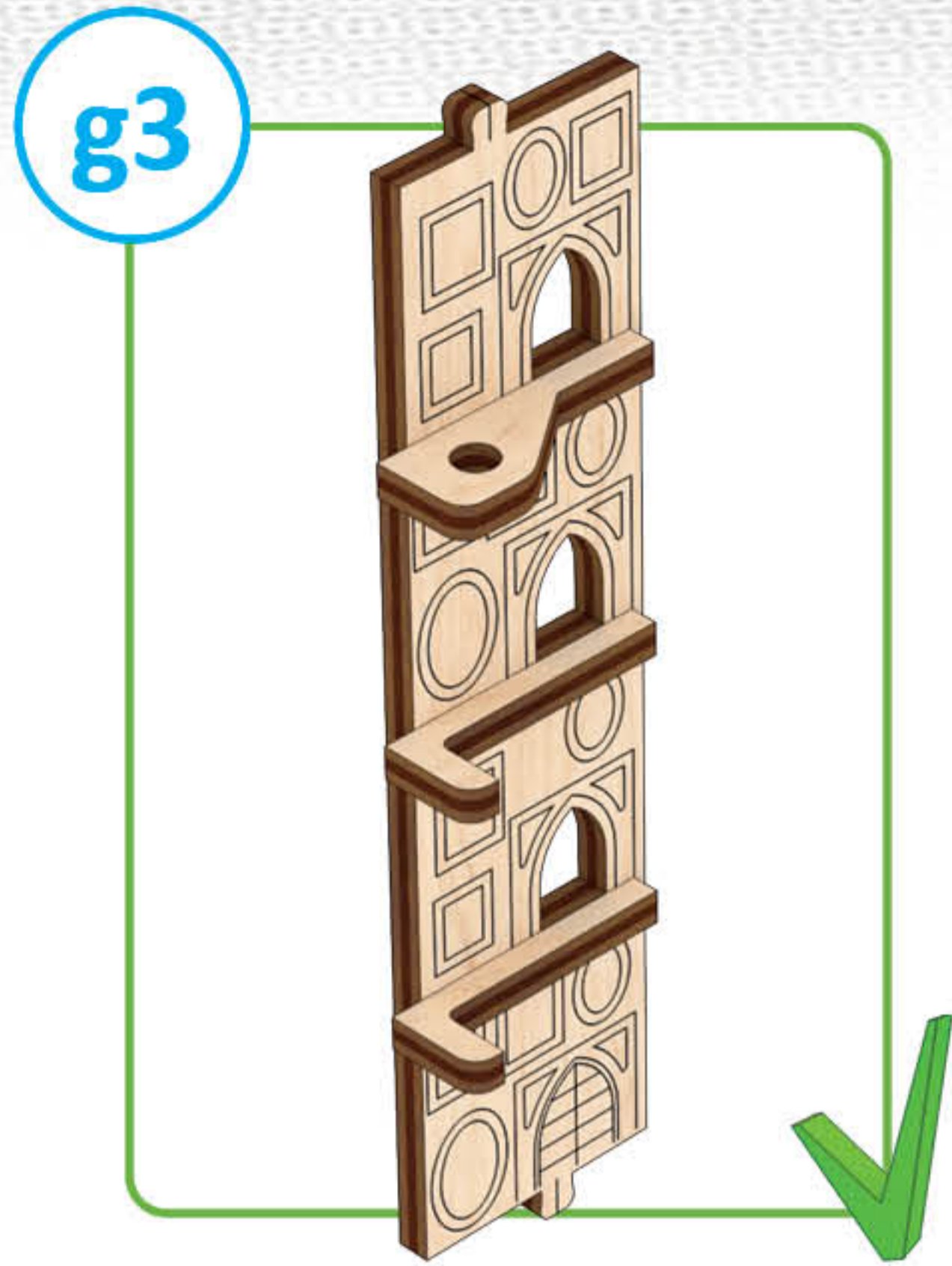
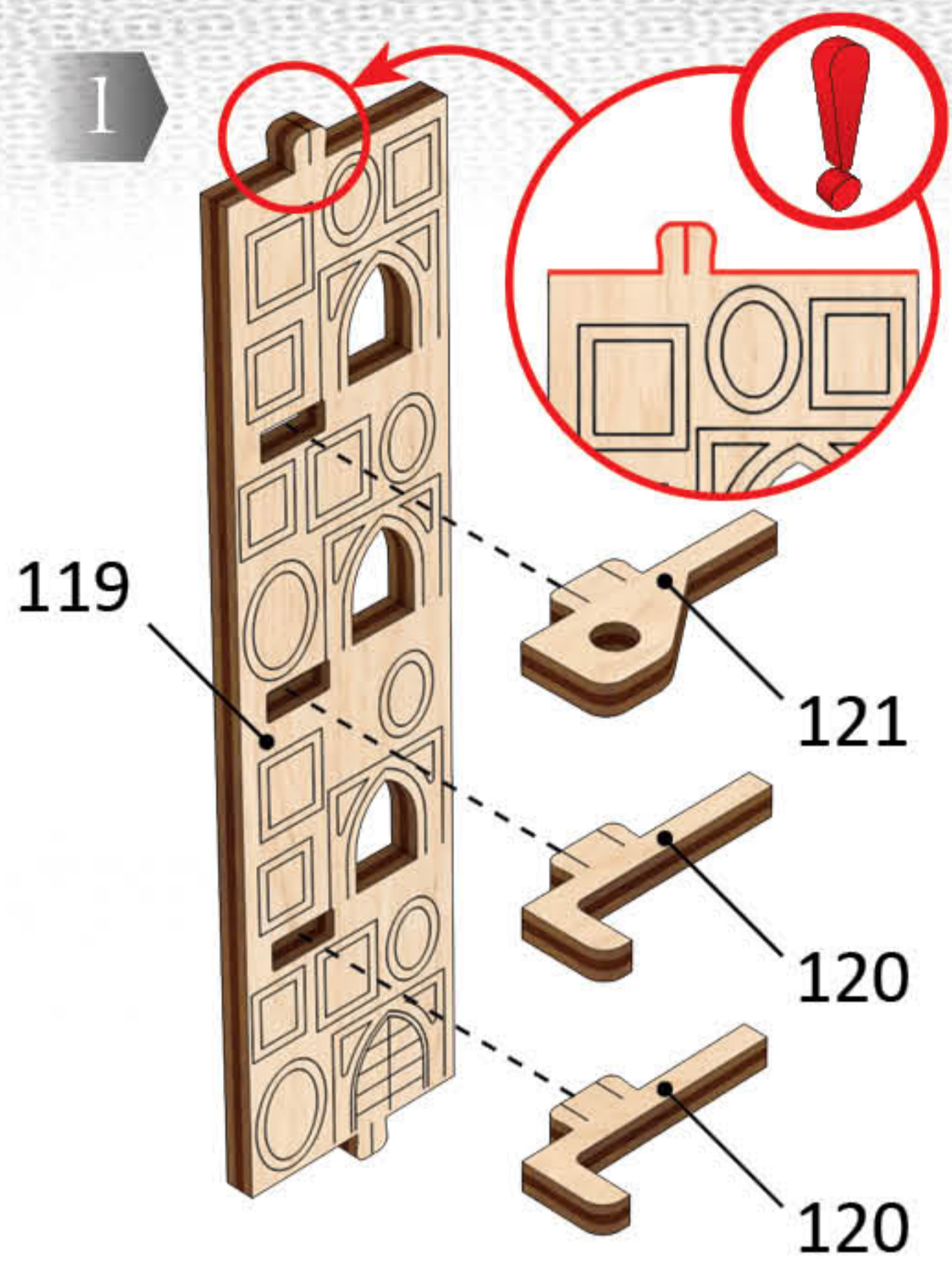
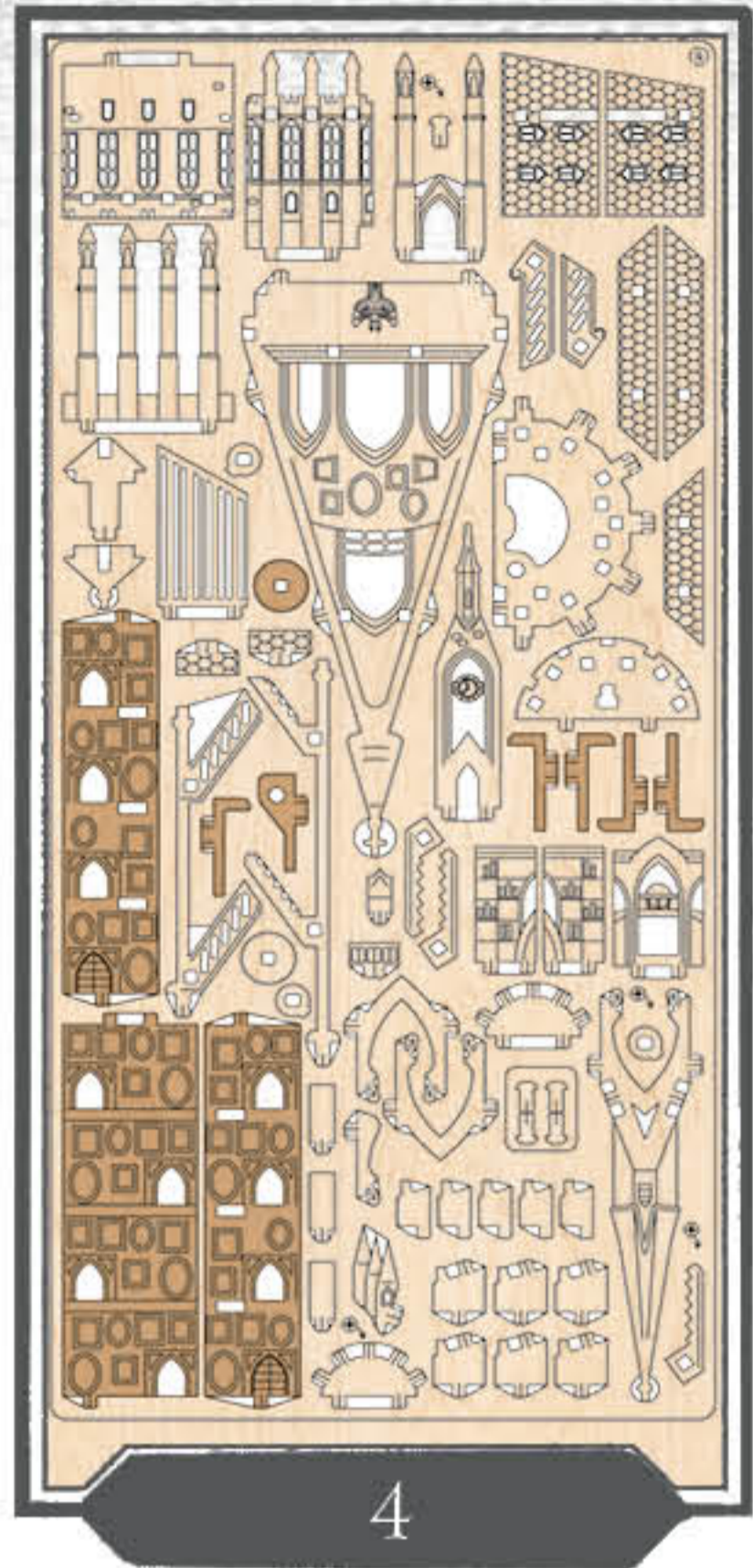

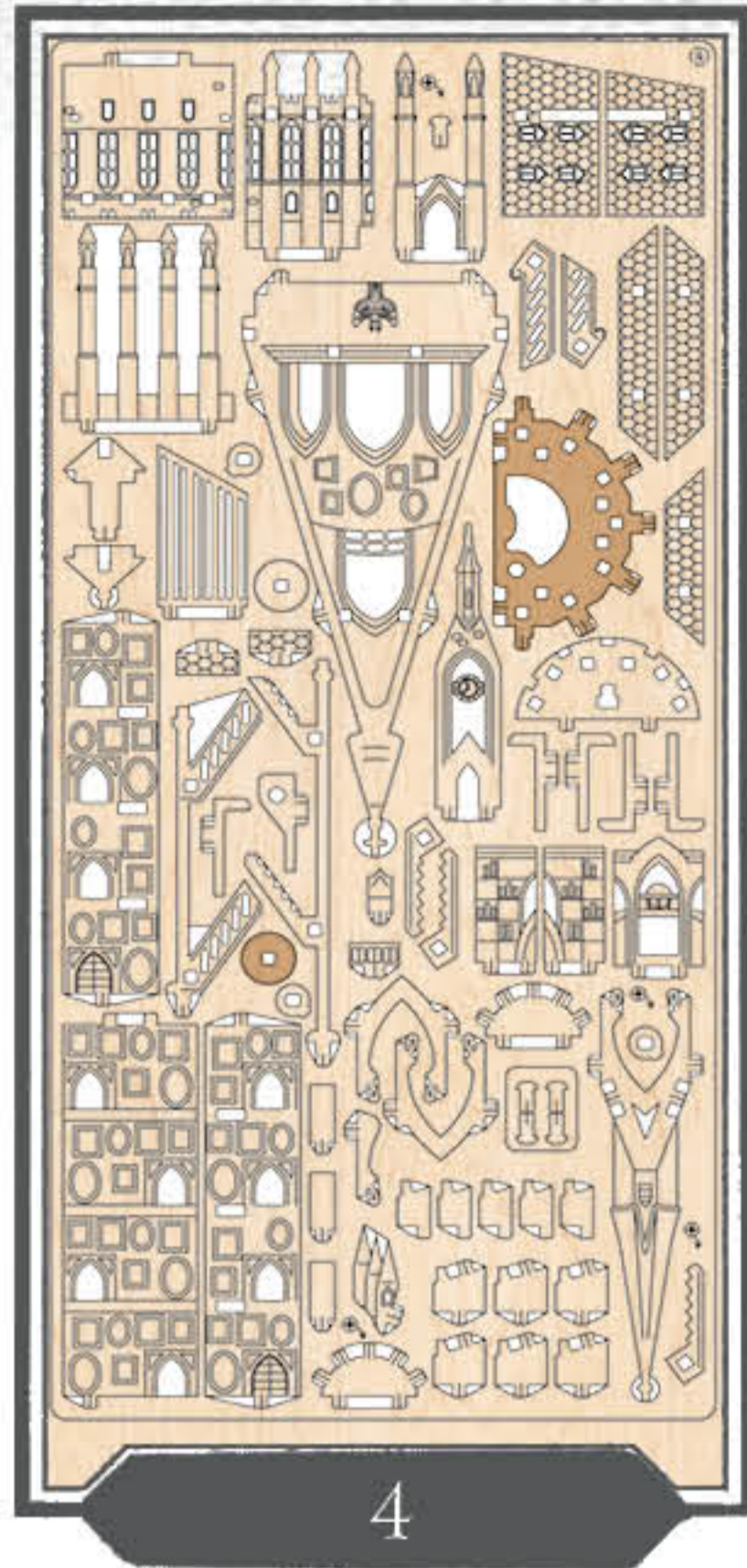

3

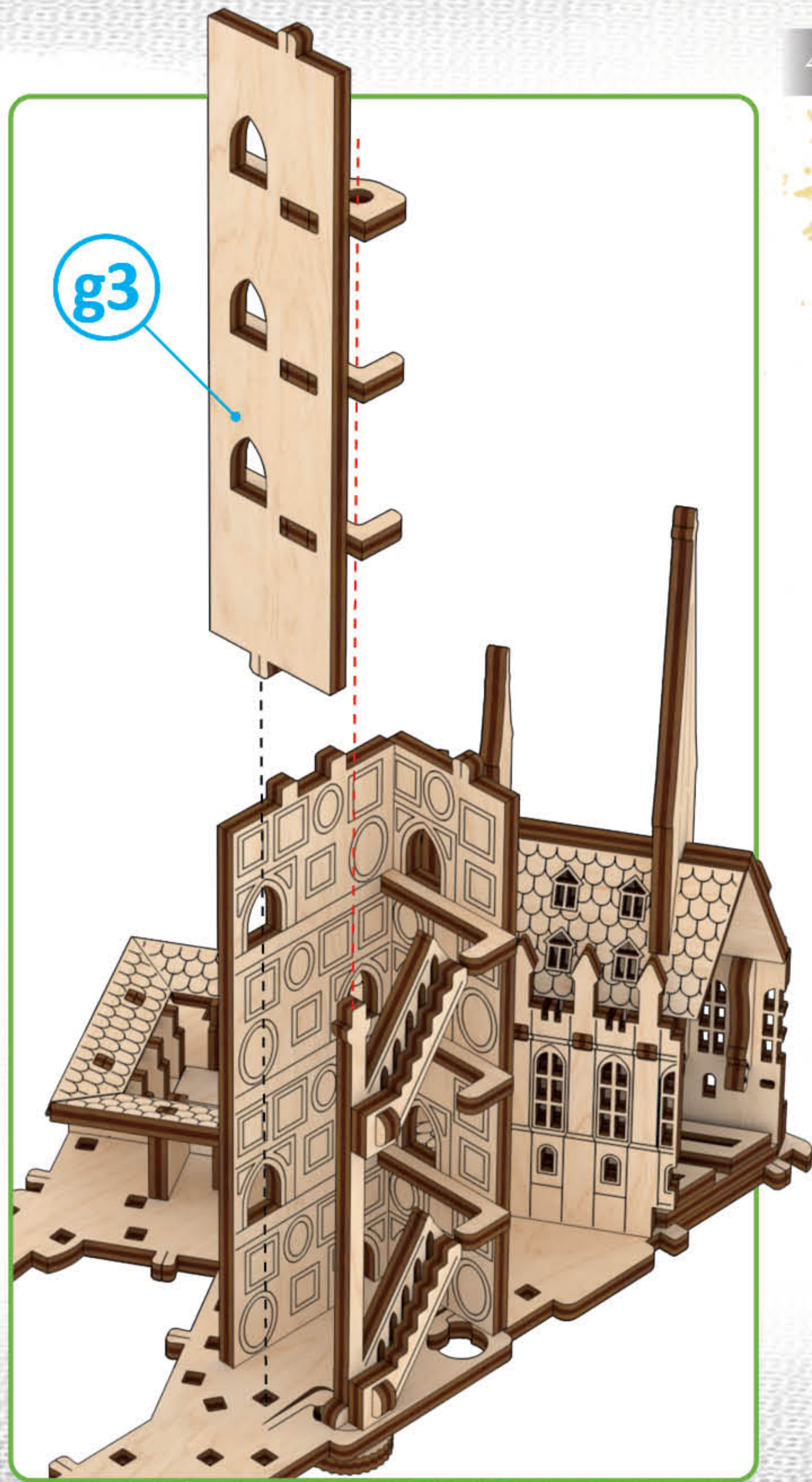

4



5

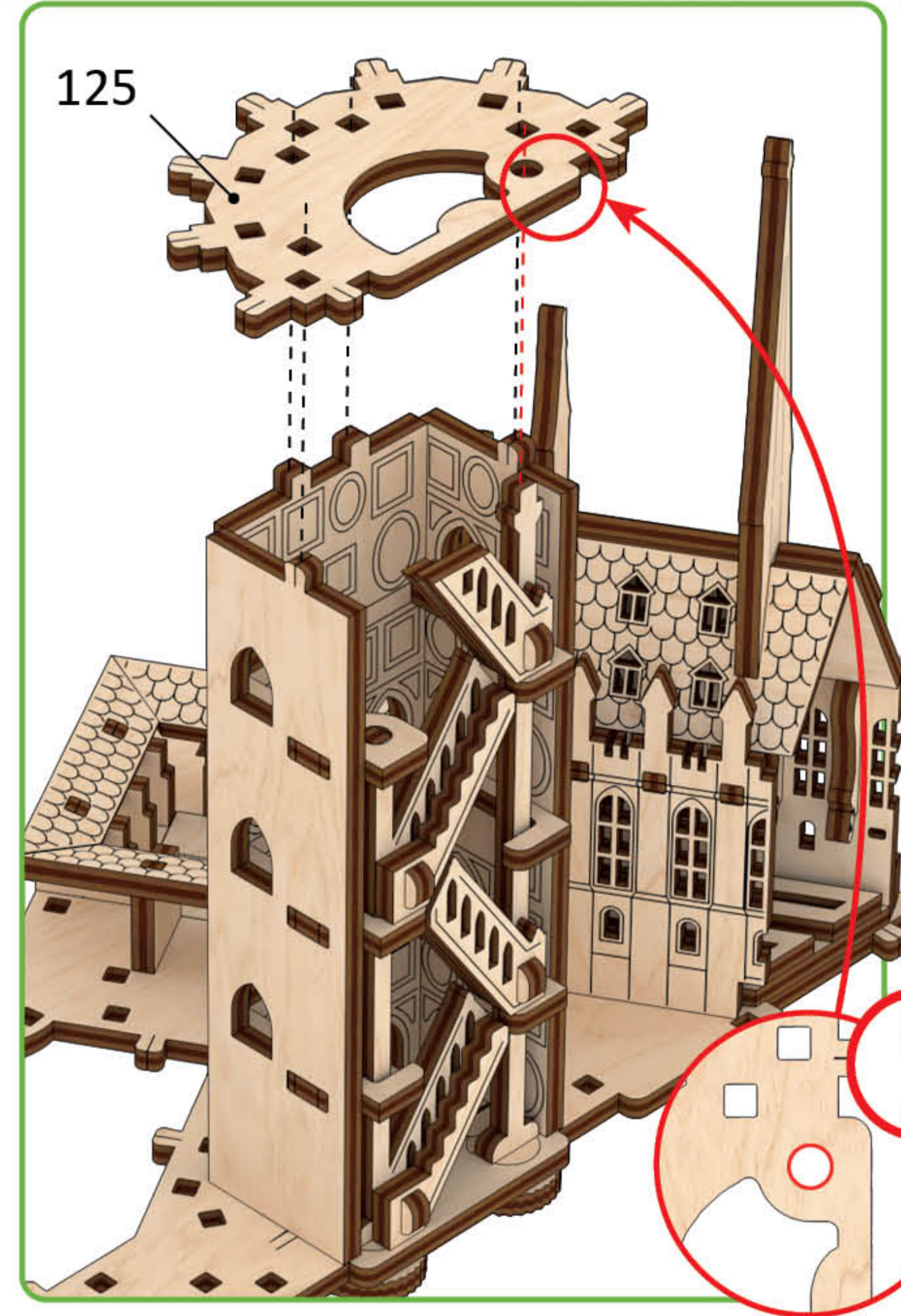

G

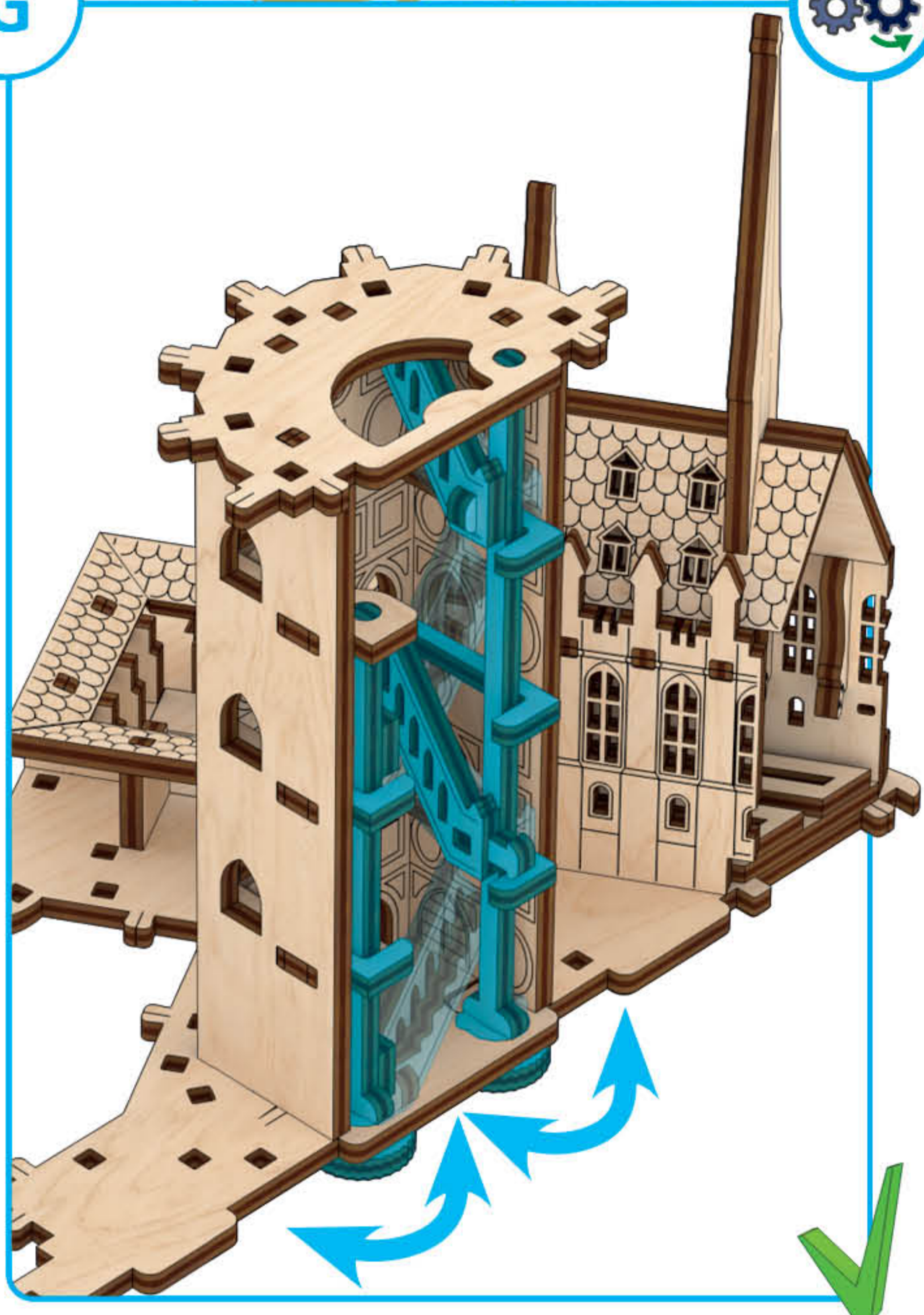

ENG Check the mechanism for smoothness and accuracy of movement. Operate the mechanism so the parts would seat-in. UKR Перевірте механізм на плавність і точність ходу. Розробіть механізм. FRA Vérifiez si le mécanisme fonctionne en douceur et avec précision. Faites fonctionner le mécanisme jusqu'à son fonctionnement normal. DEU Prüfen sie den Mechanismus bezüglich der Laufruhe und der Genauigkeit des Ganges. Betätigen Sie den Mechanismus mehrmals. SPA Verifique la suavidad y precisión del mecanismo. Desarrolle el mecanismo. ITA Controllare la scorrevolezza e la precisione del movimento. Far funzionare il meccanismo. JPN 駆動部分が滑らかに動くかを確認しながら作業をすすめます。CHI 检查机构的运行平稳度和精密度。调整机构。POR Teste a suavidade e precisão do movimento do mecanismo. Opere o mecanismo para que as peças se encaixem. POL Sprawdz plynność i dokładność ruchu mechanizmu. Dopracuj mechanizm. KOR 구동 부분의 원활한 작동과 정확한 움직임을 확인하세요.

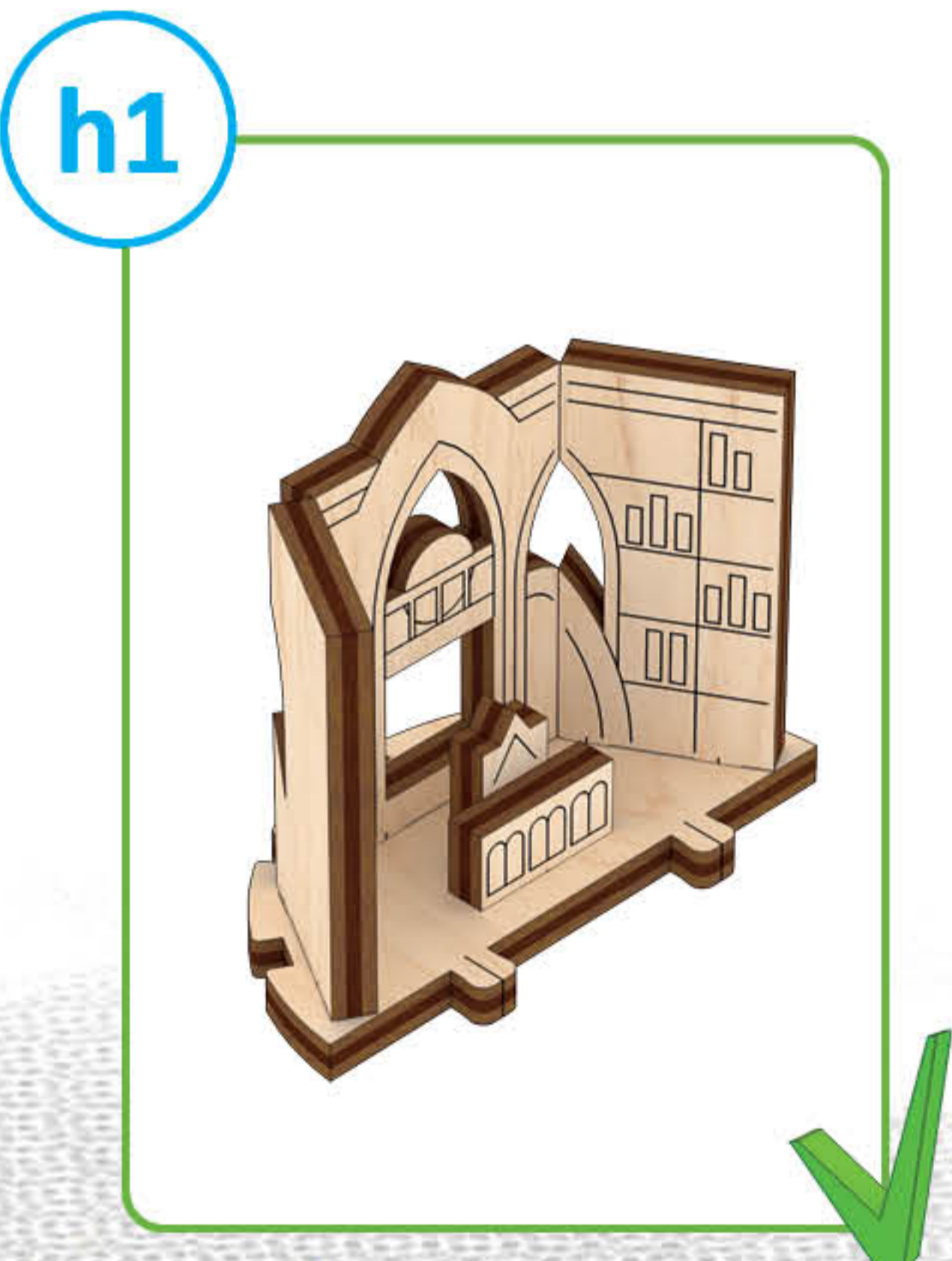
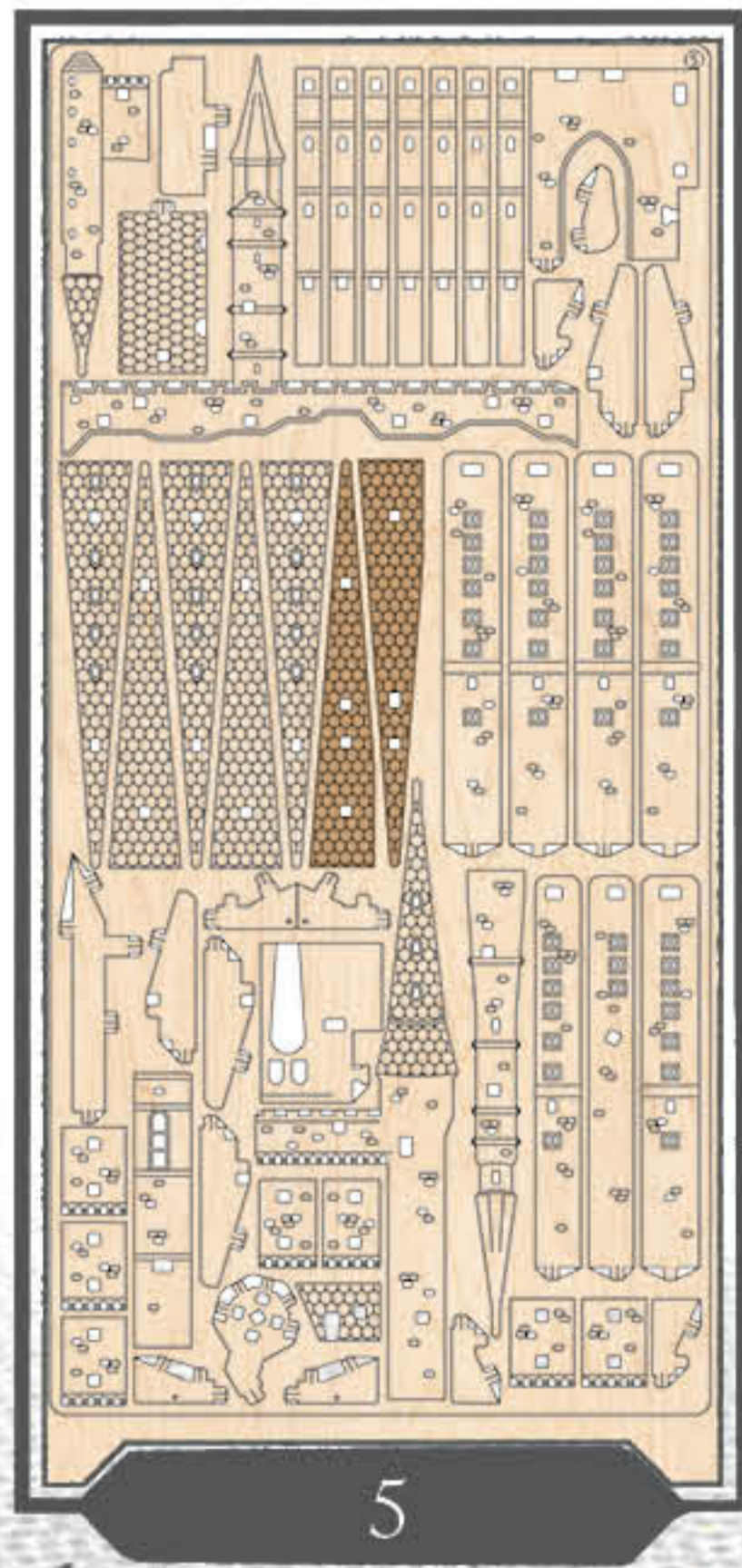
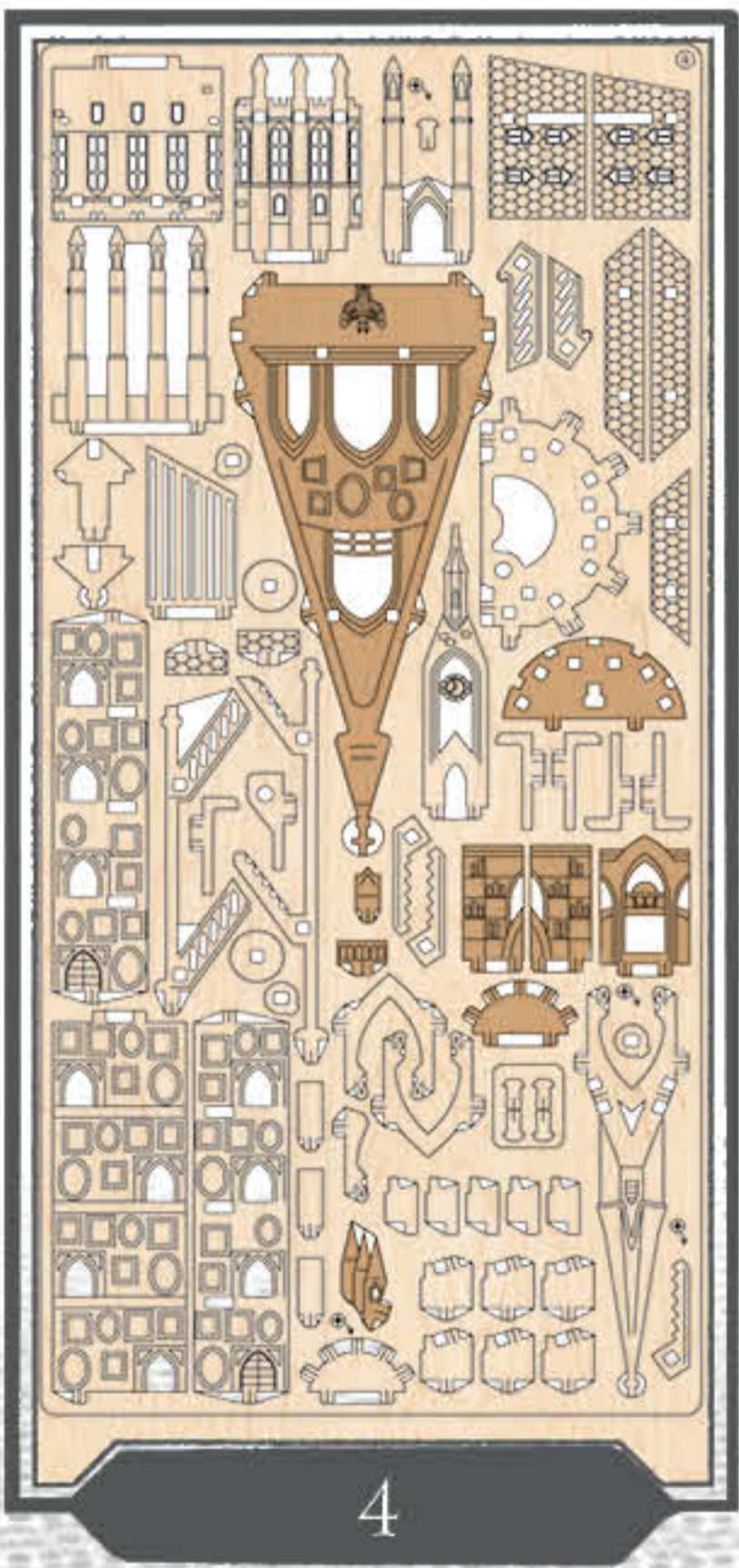
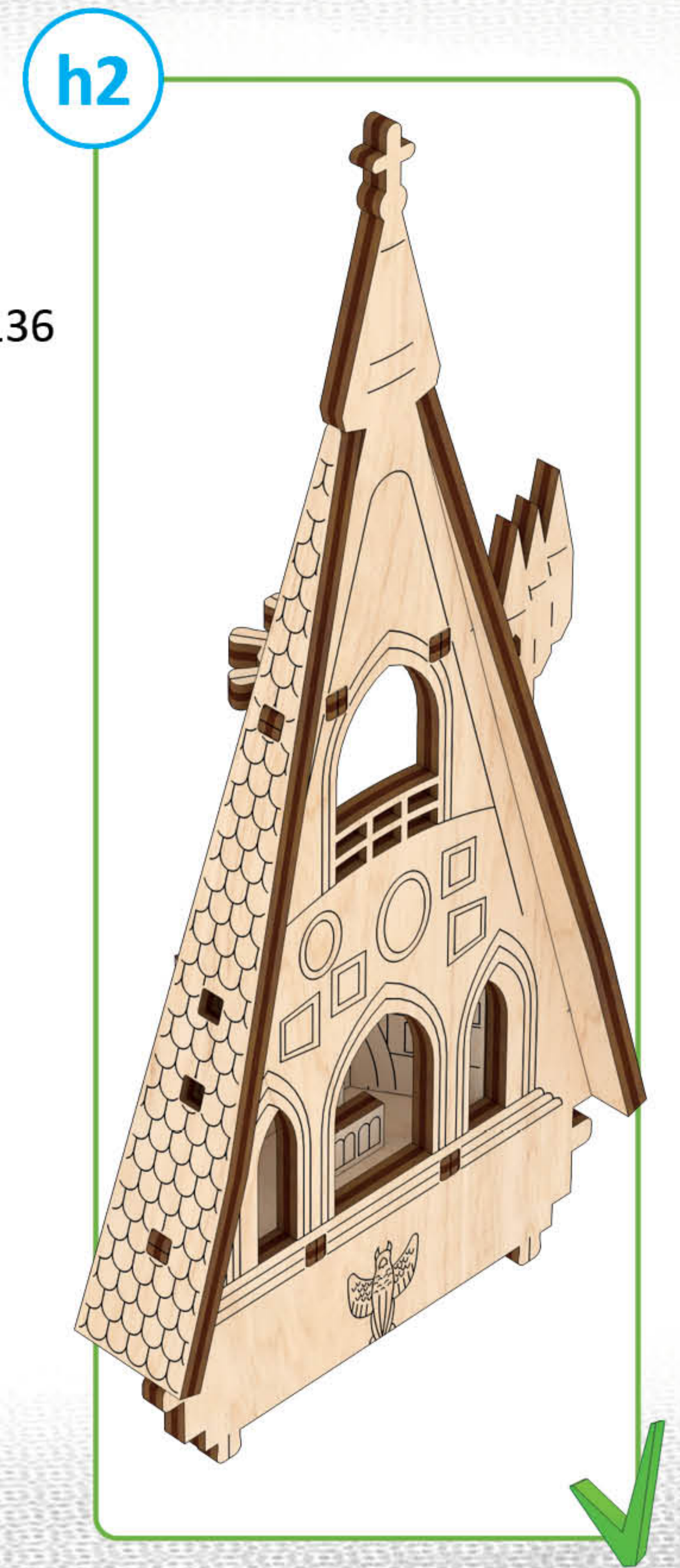
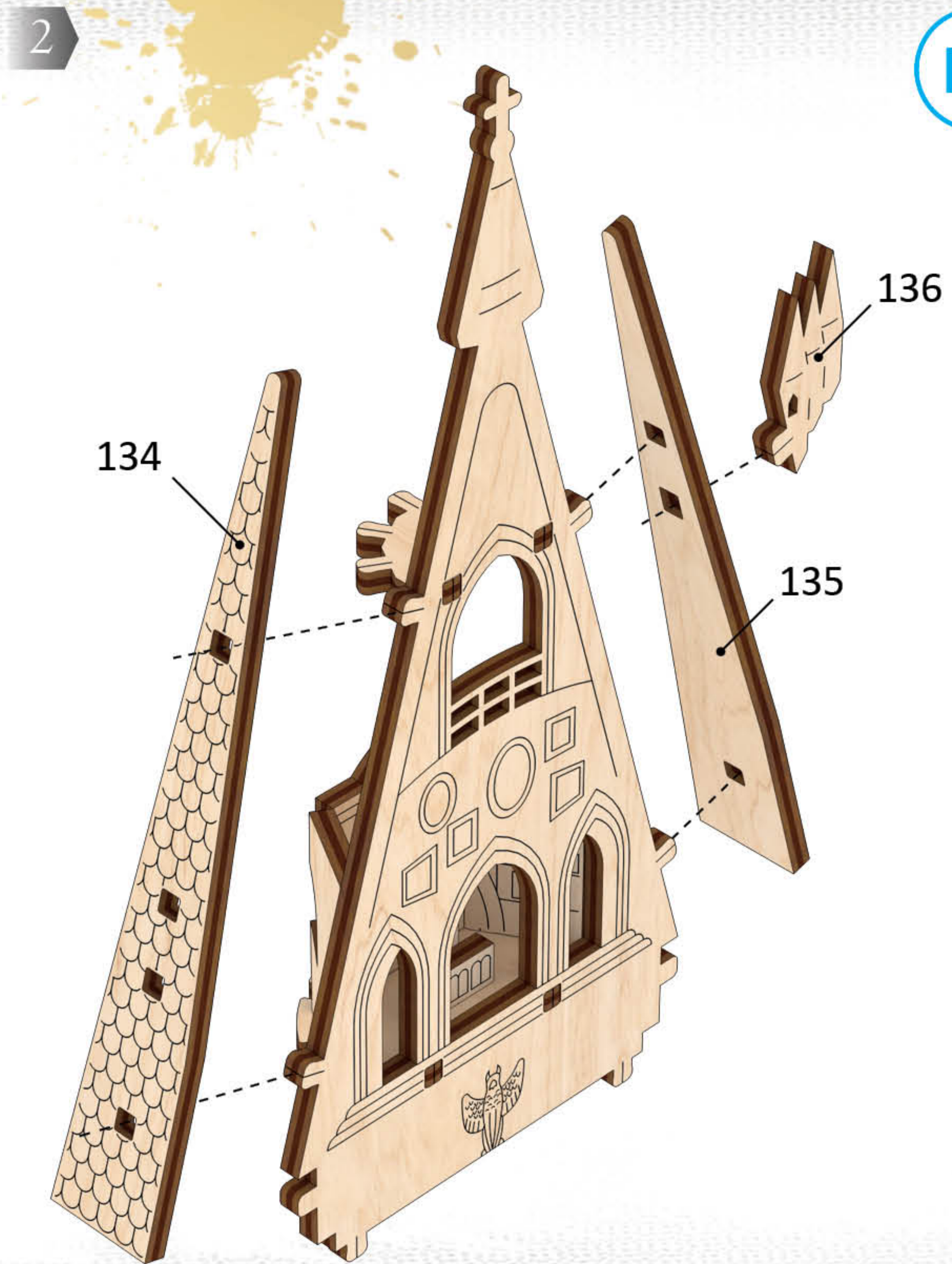
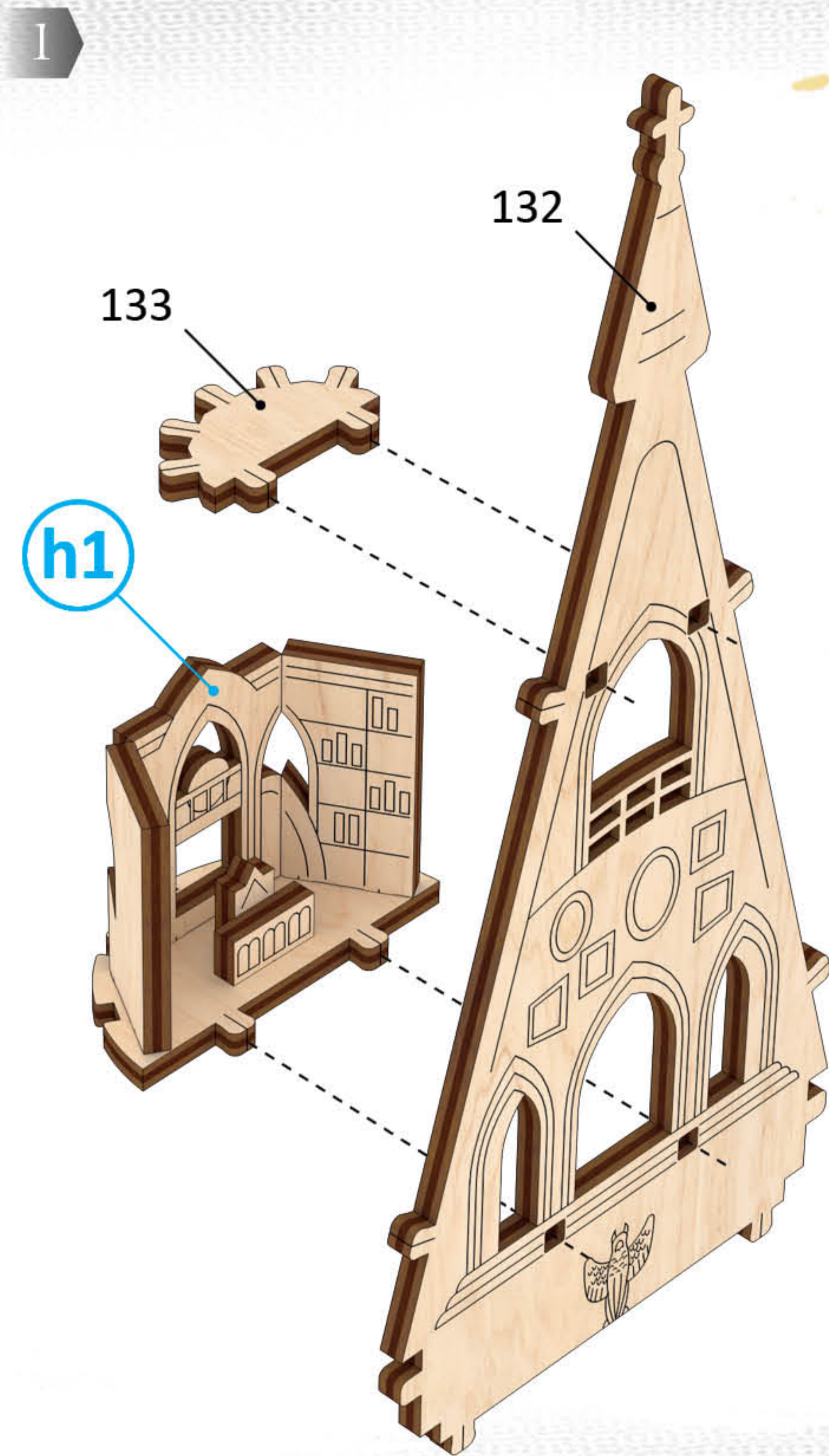
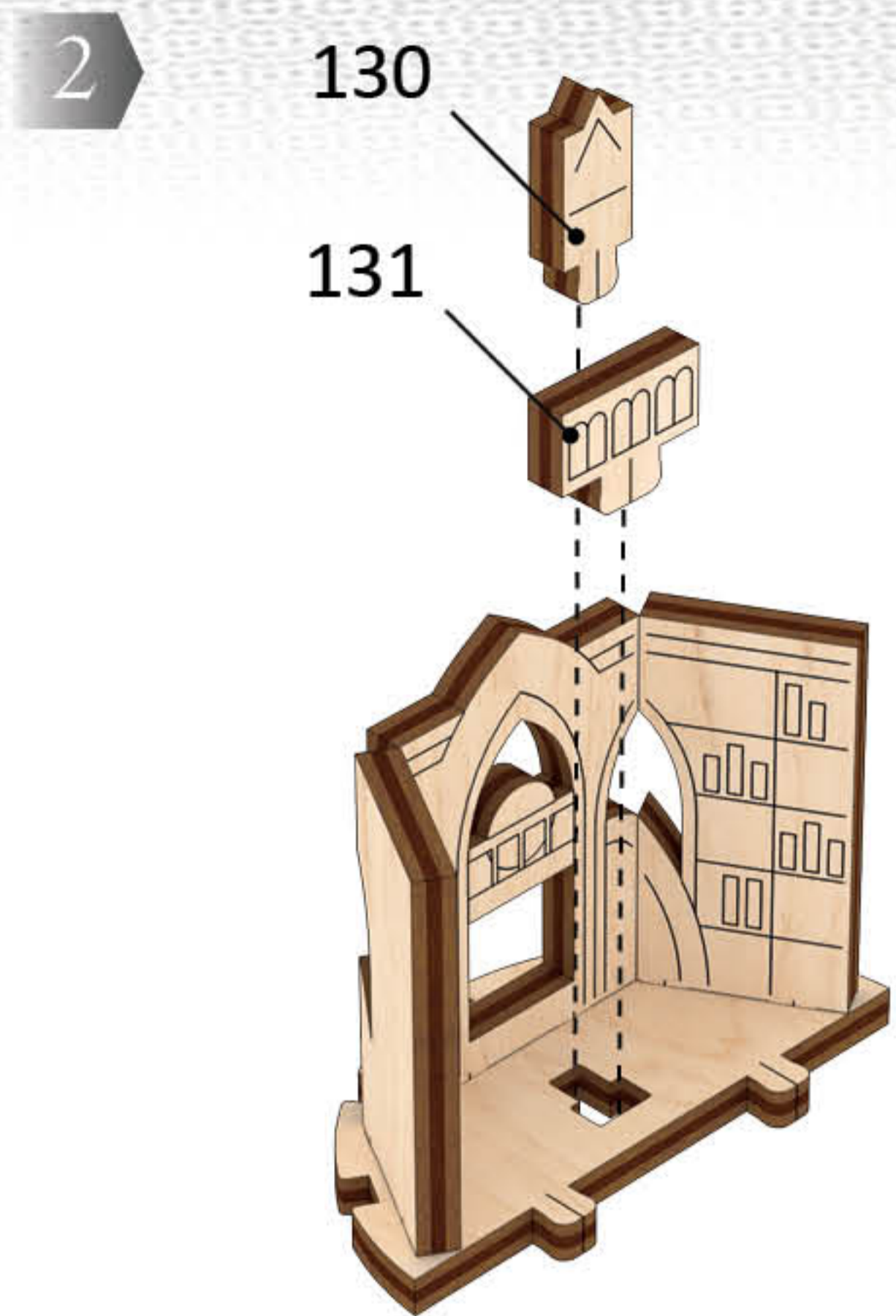
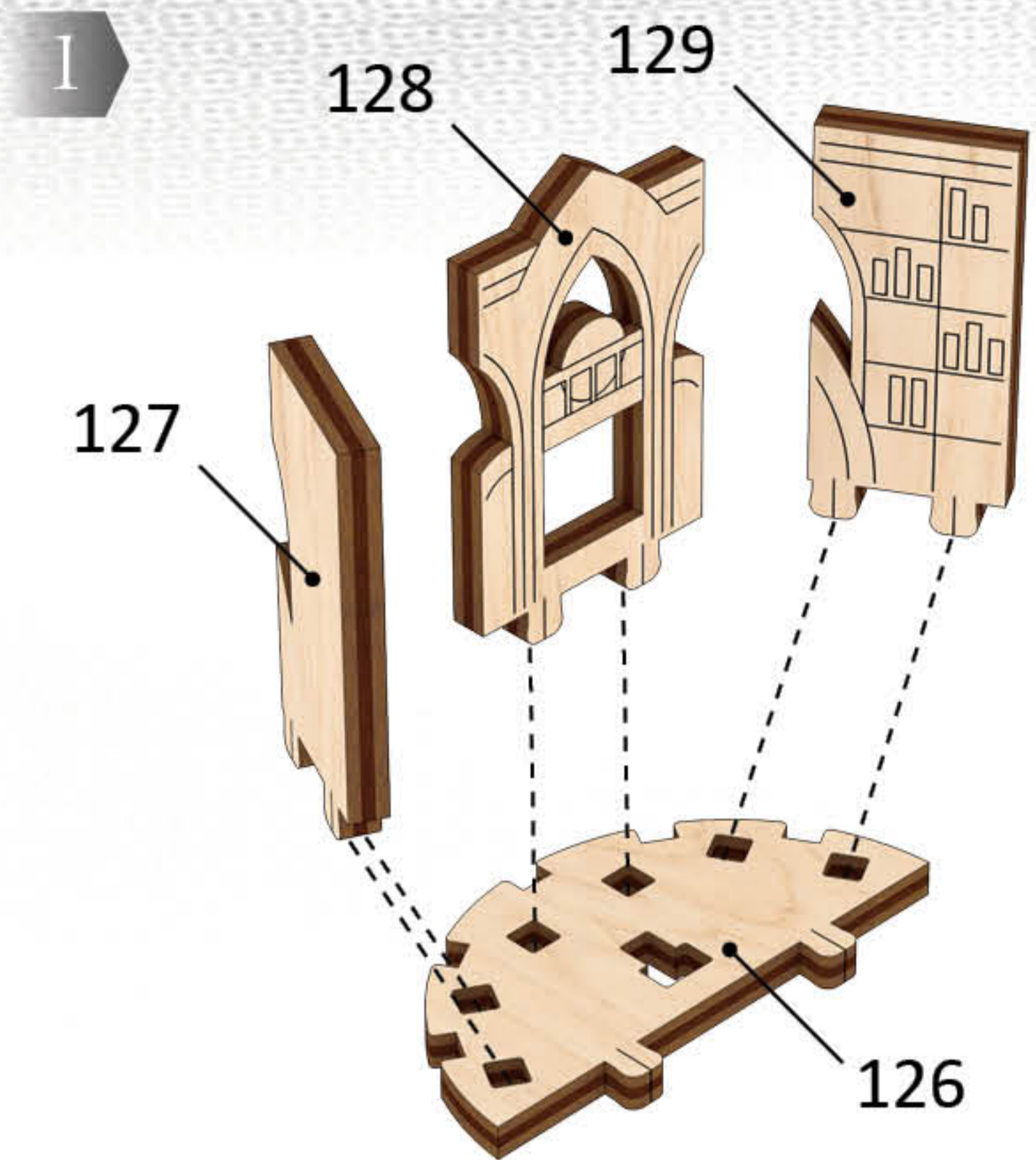

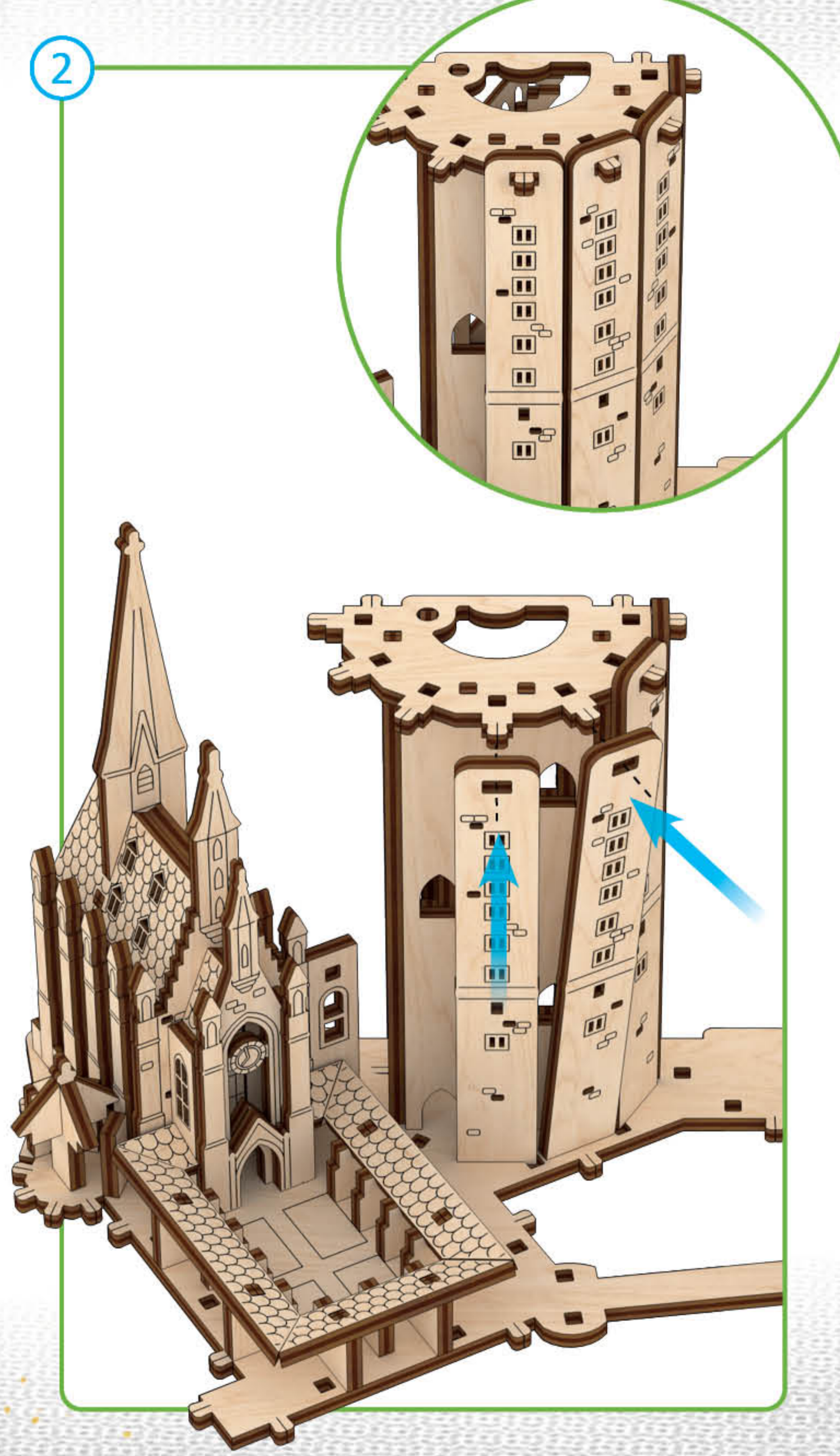
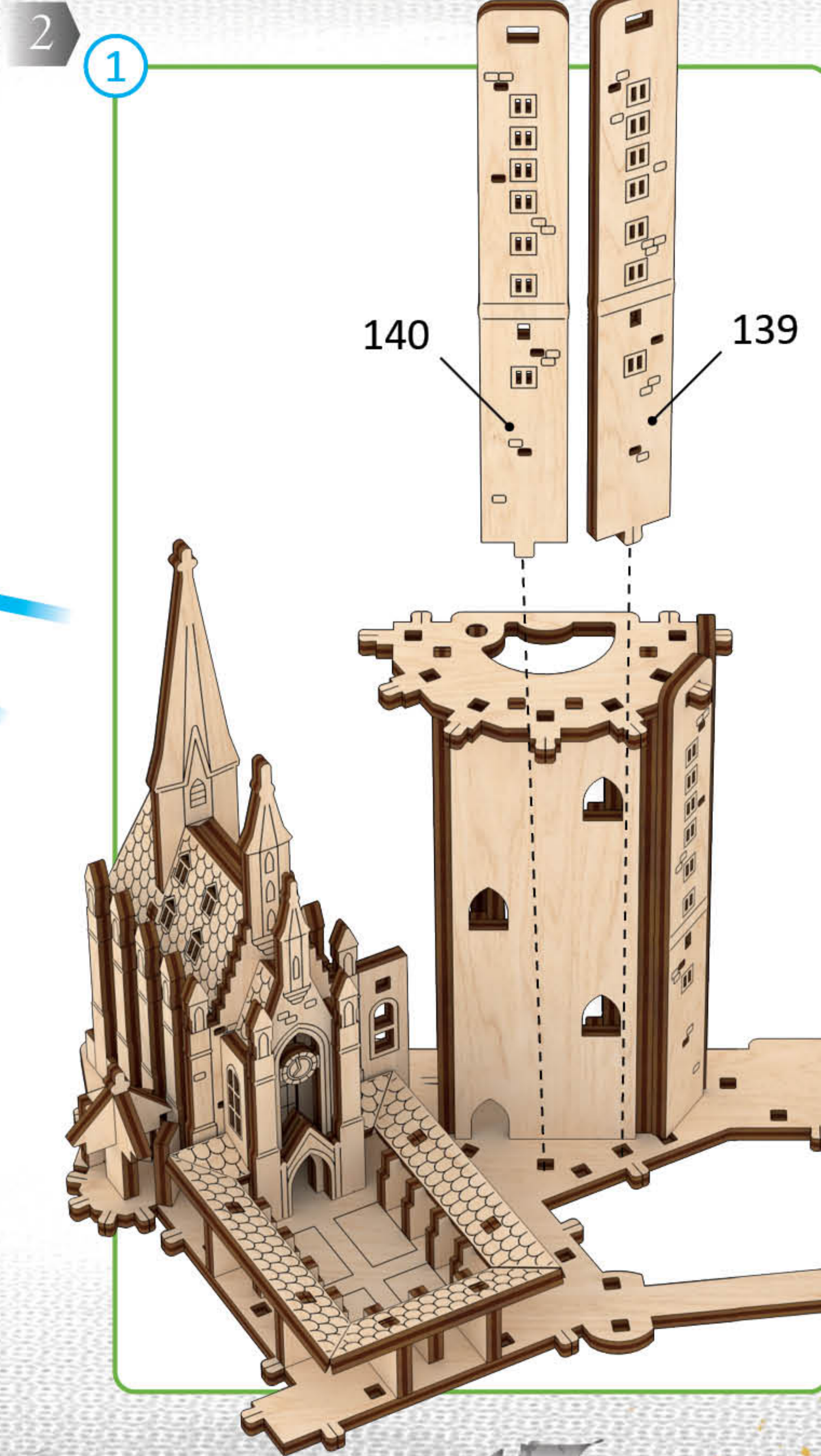
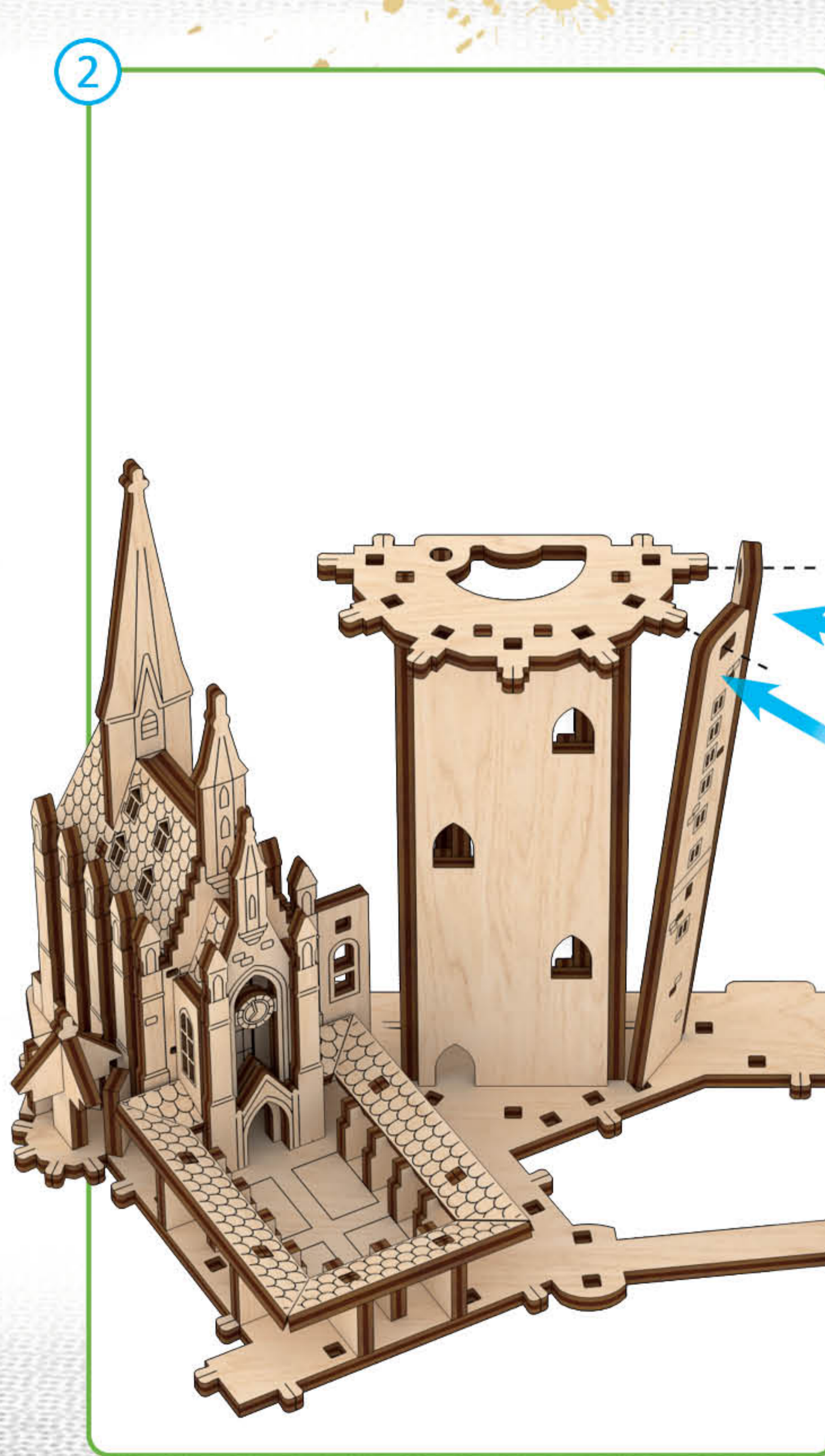
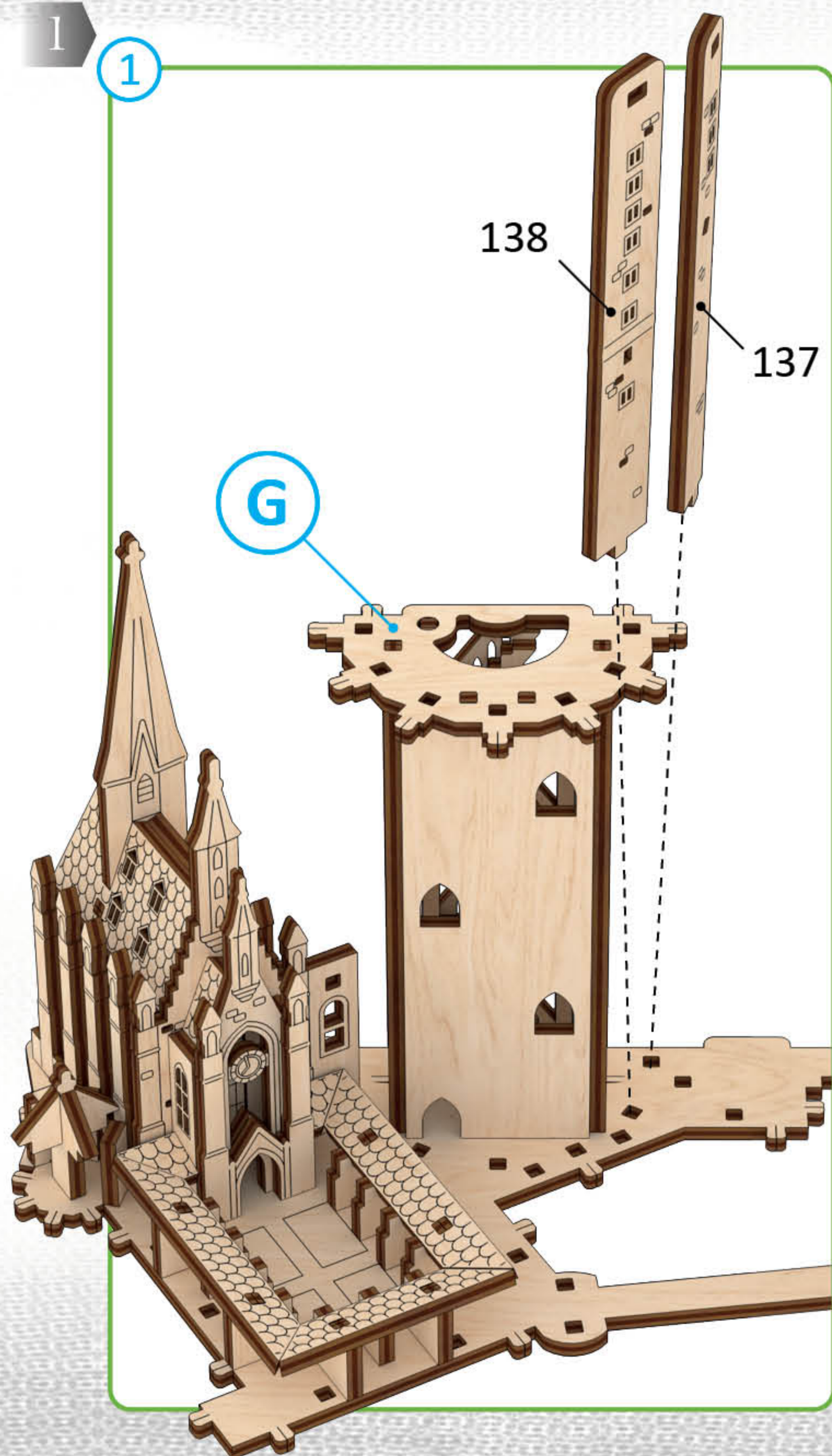
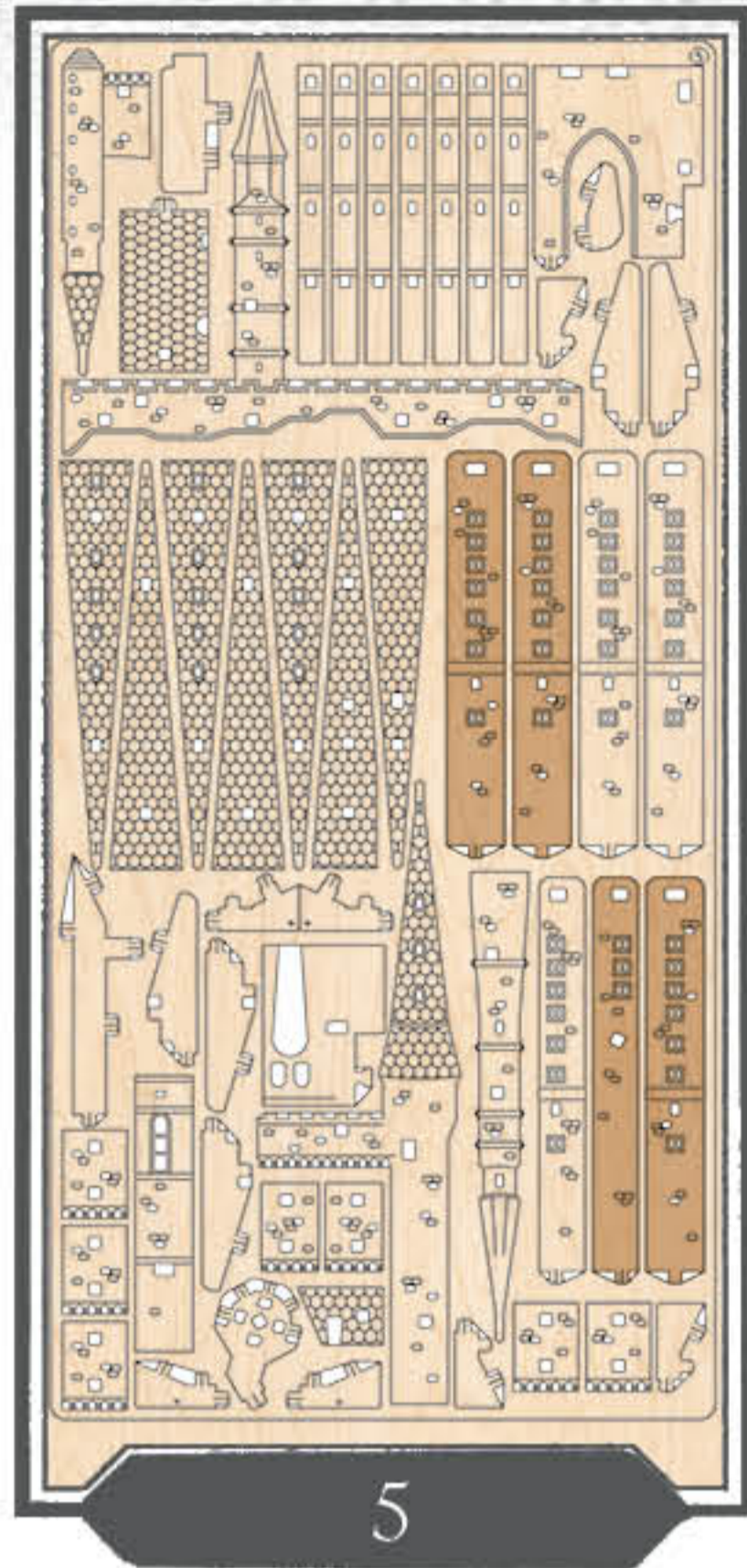

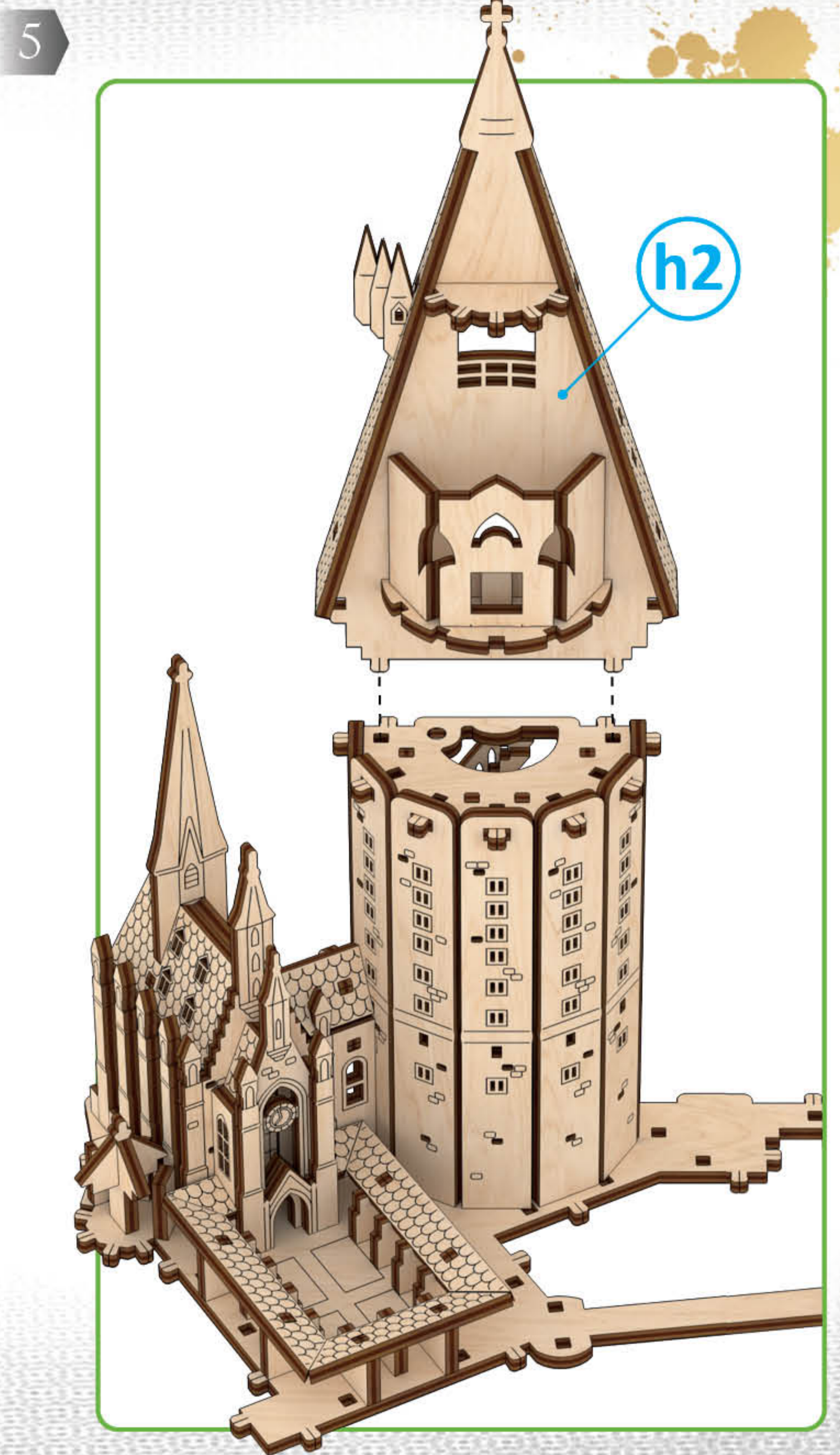
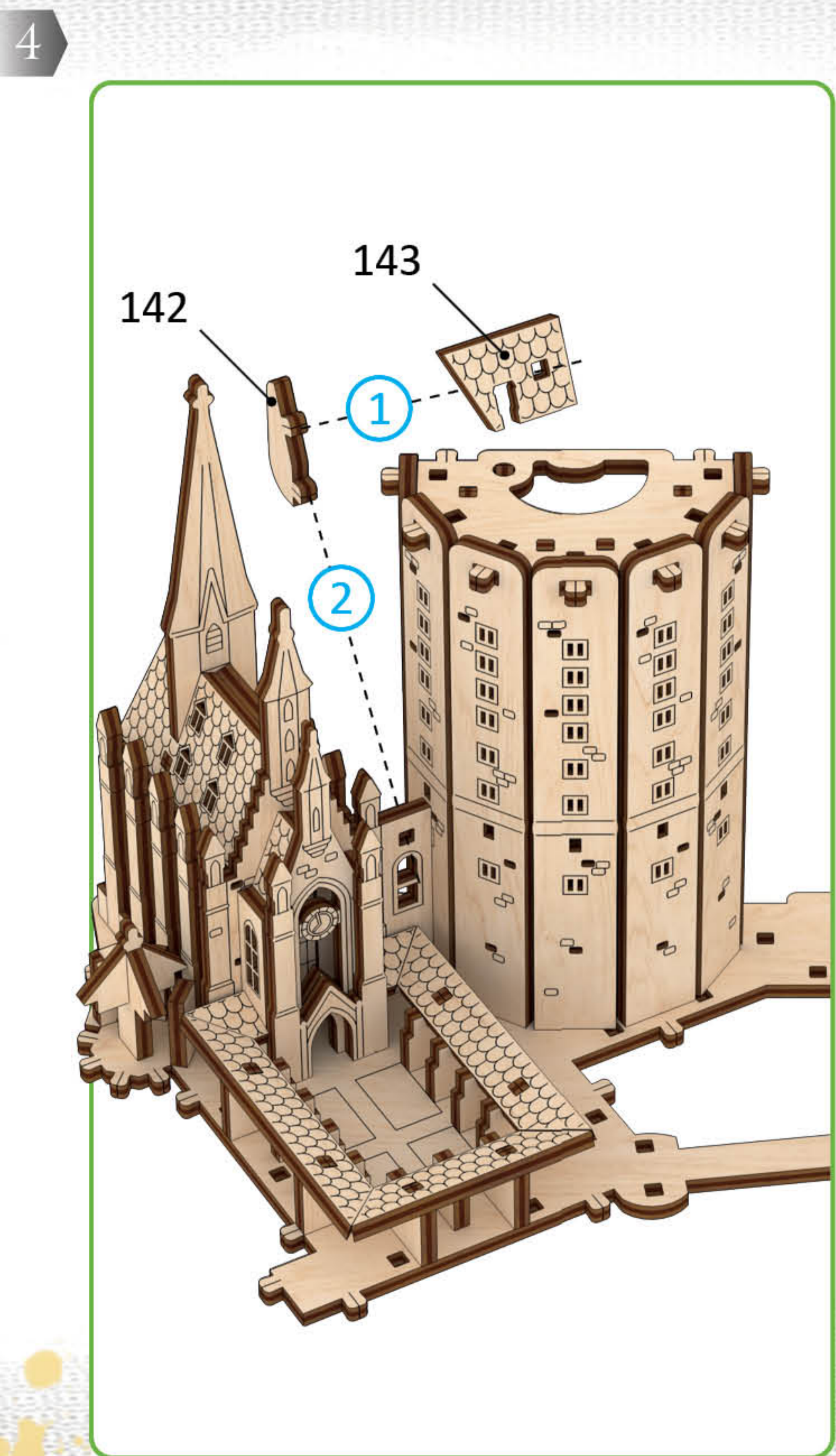
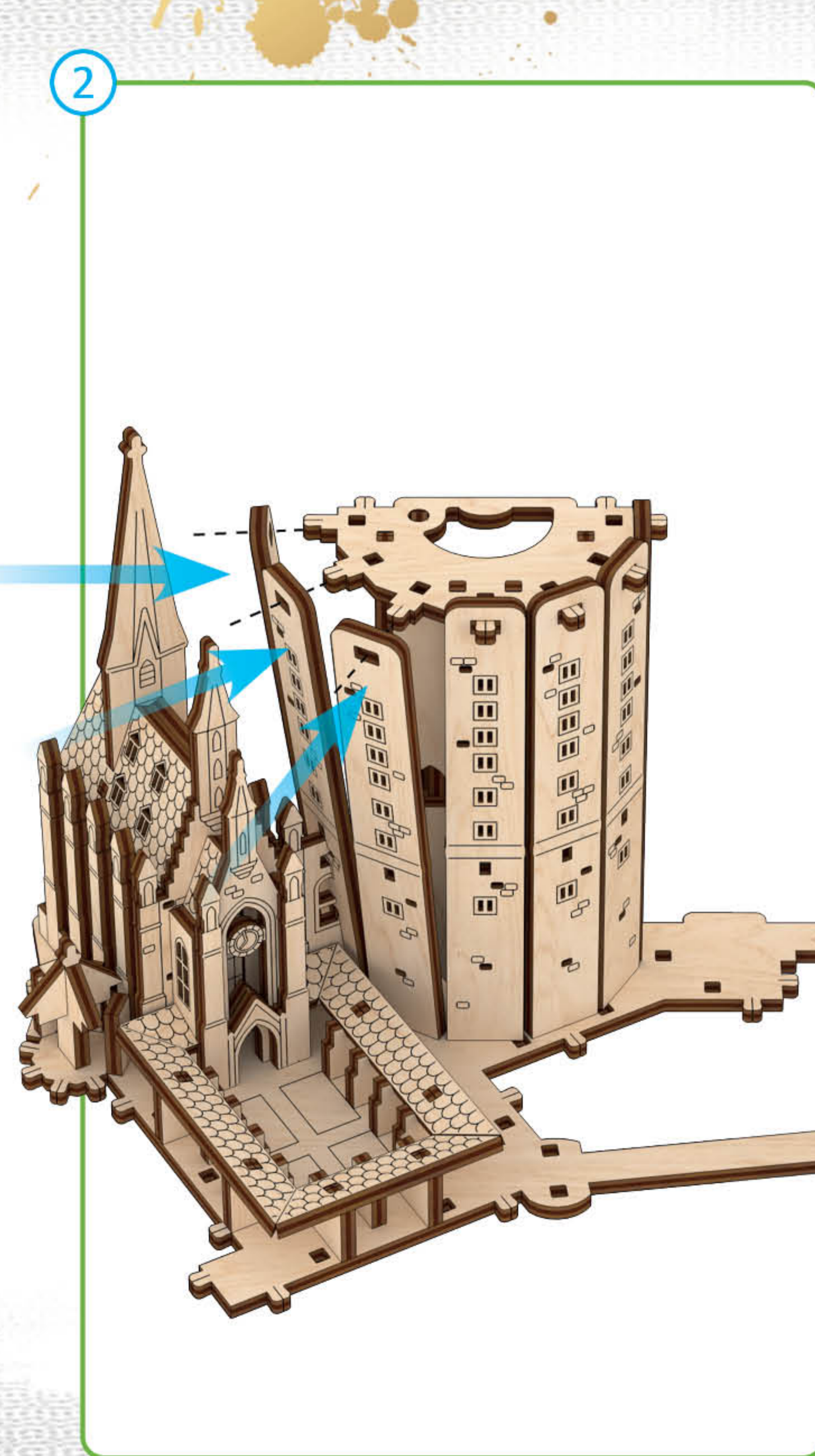
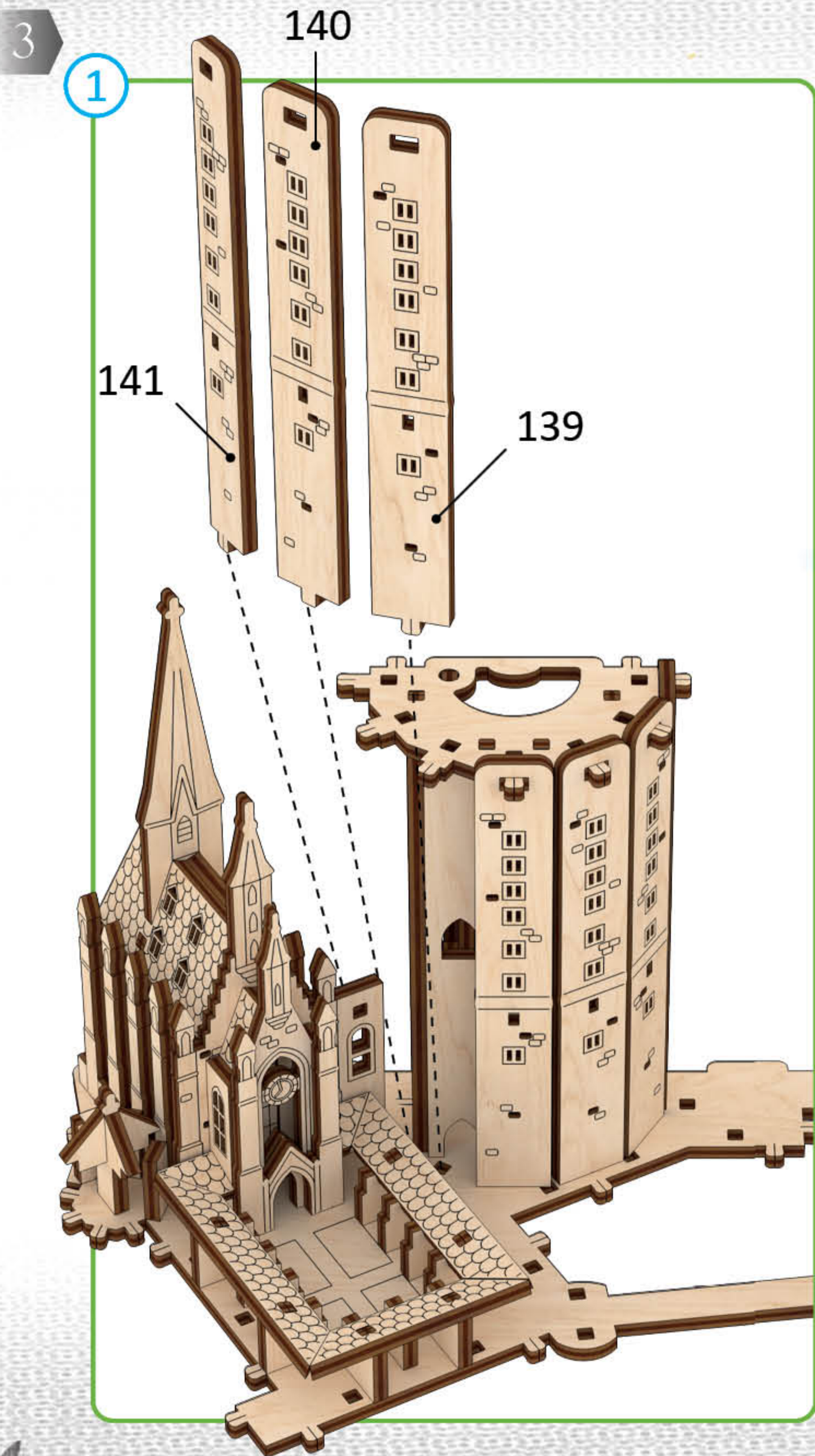
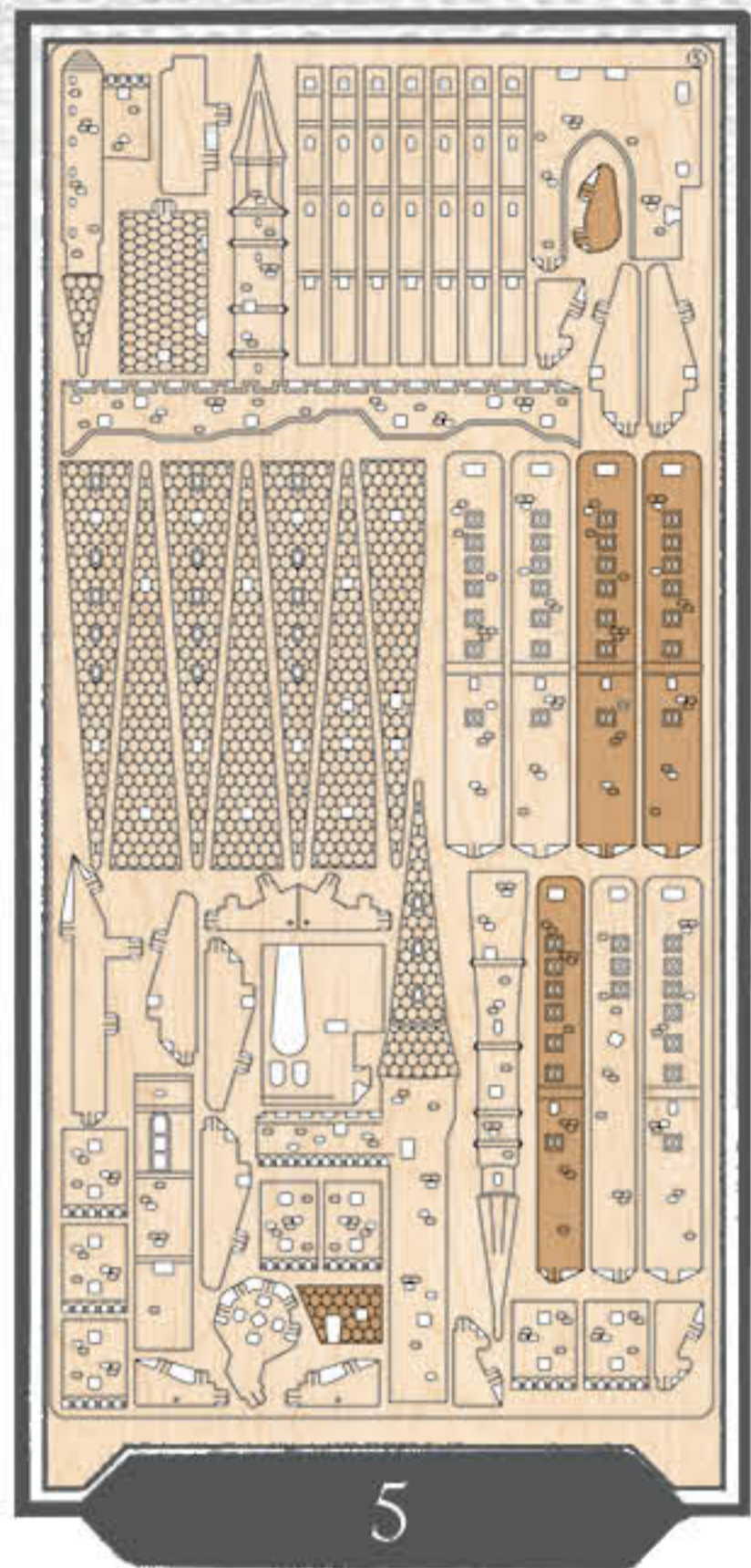

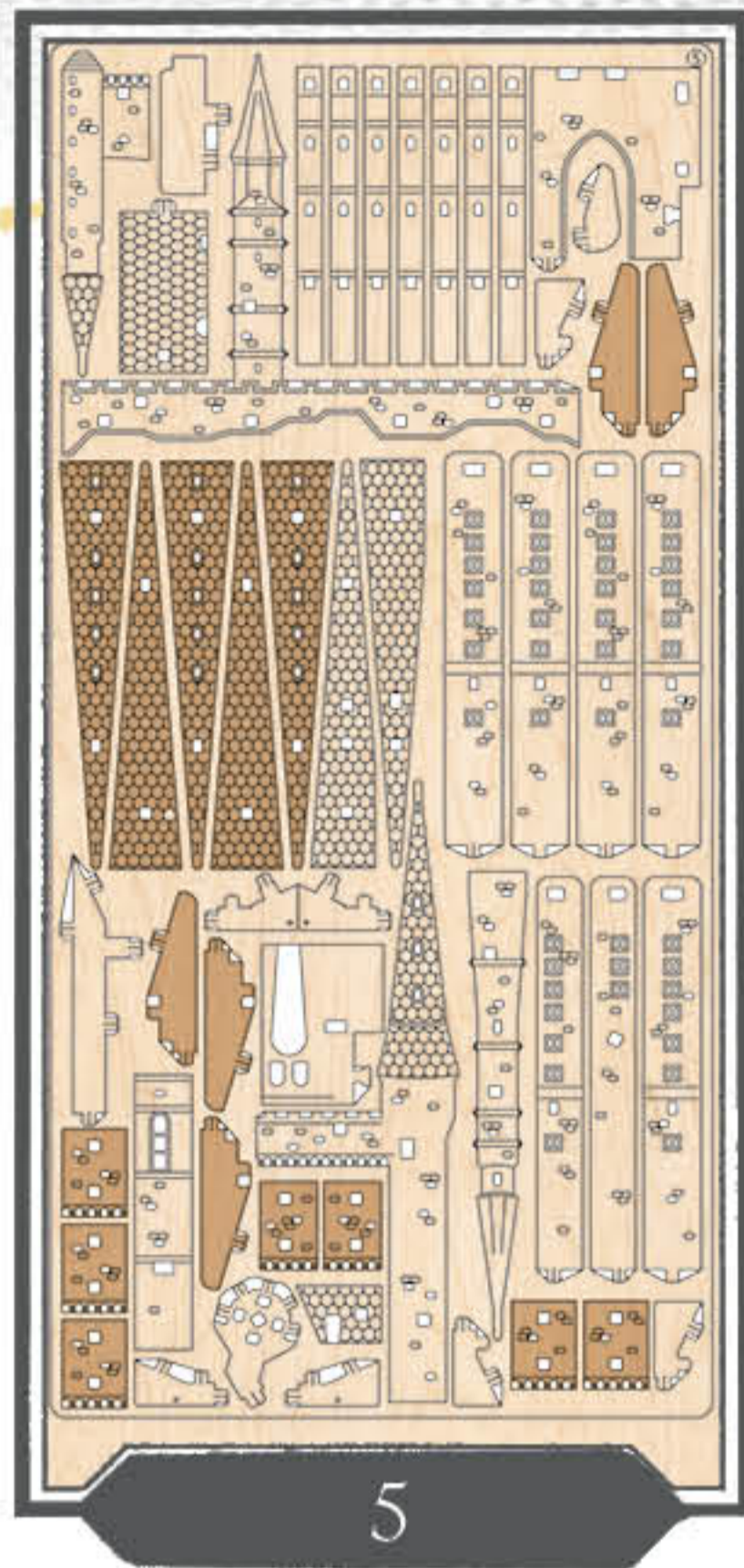

5

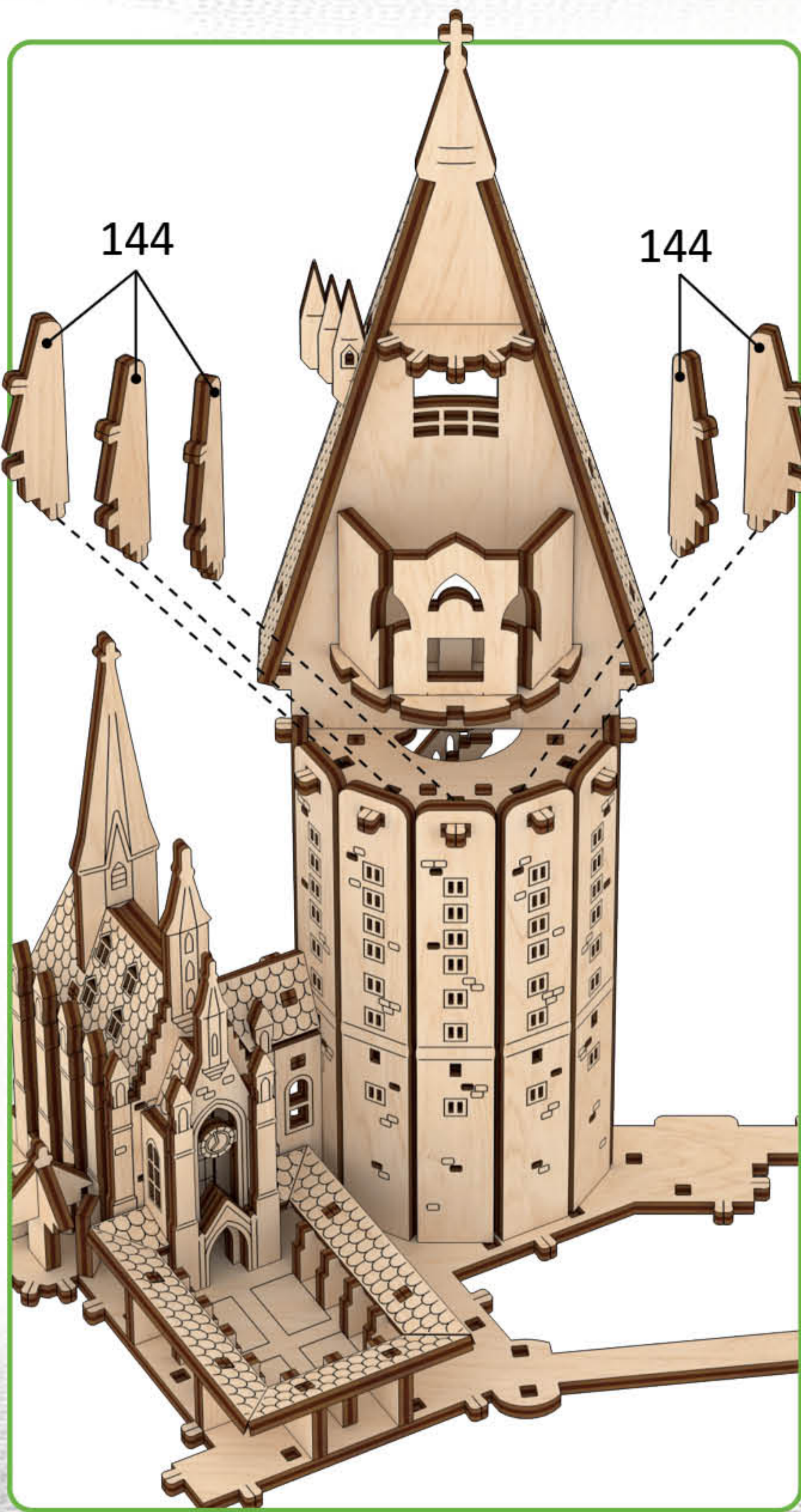

6

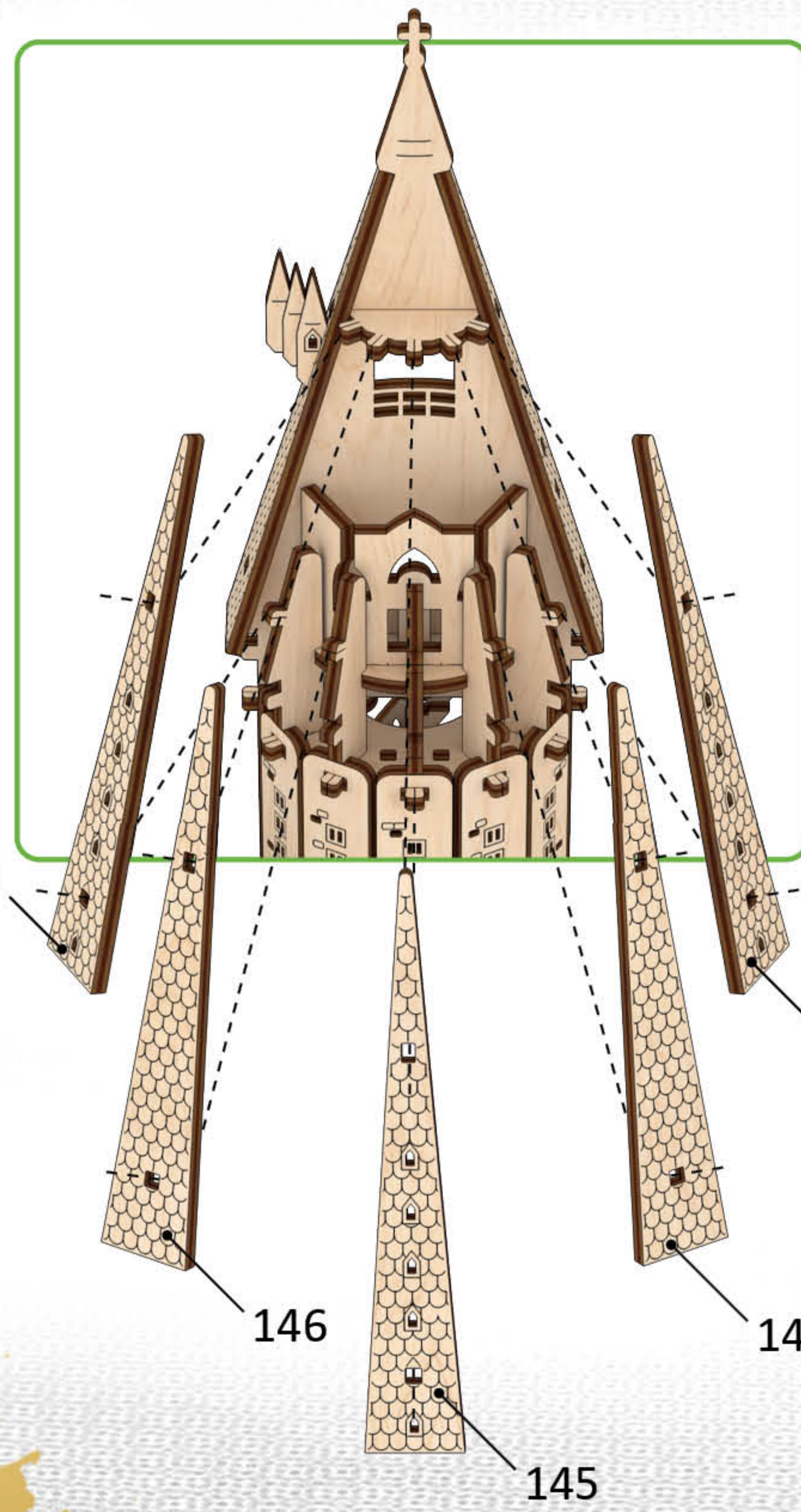

7

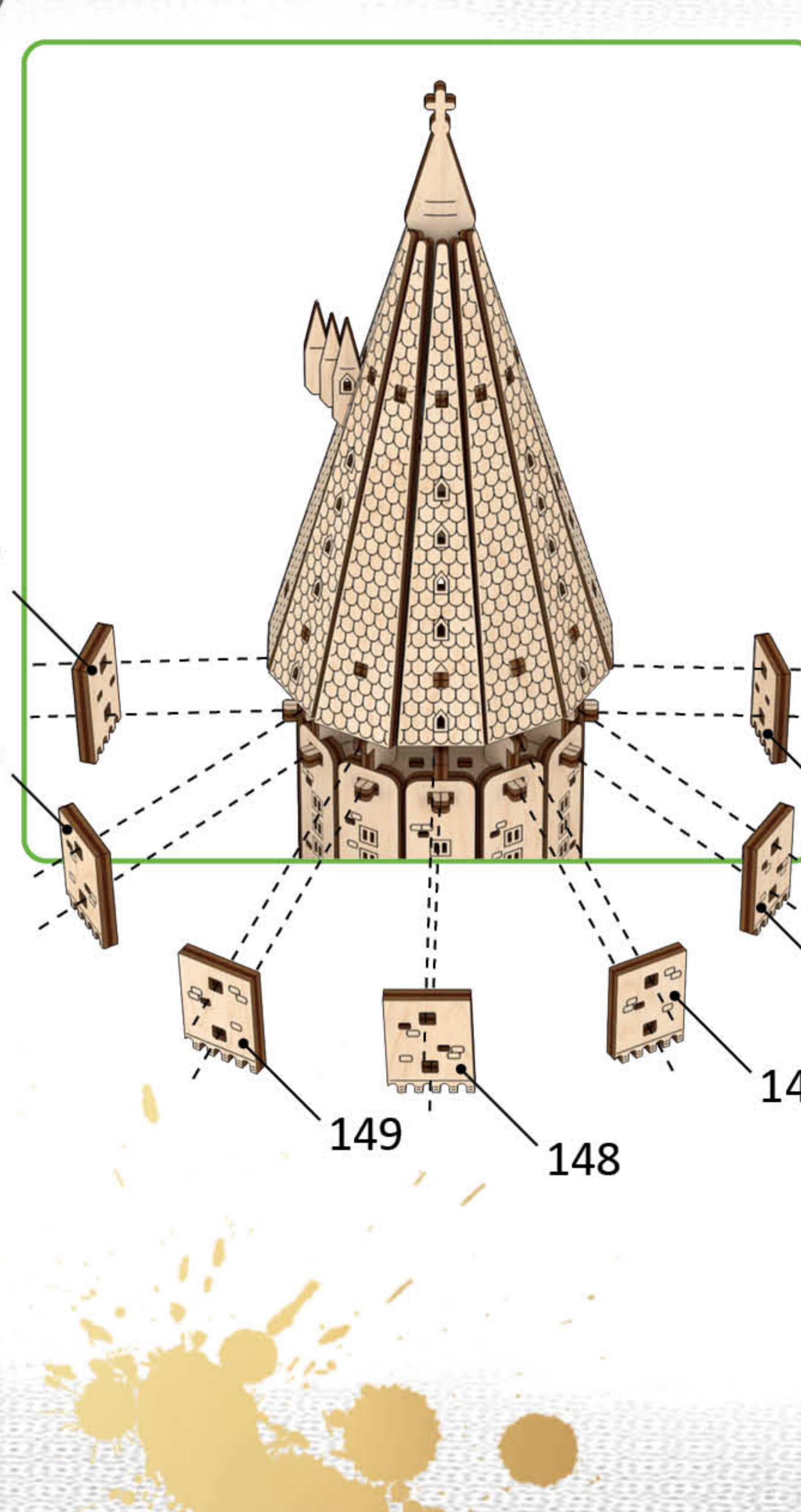

H



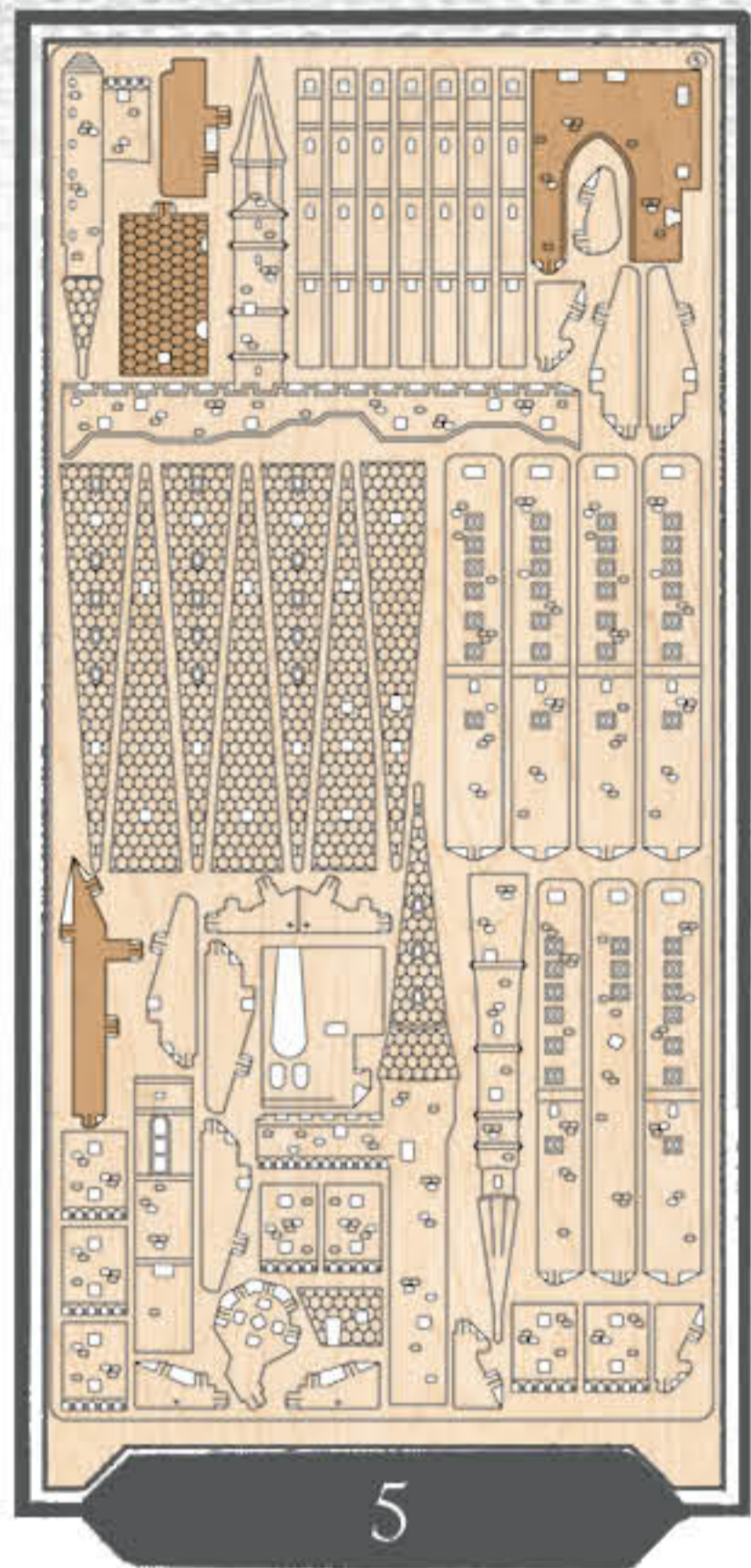

1

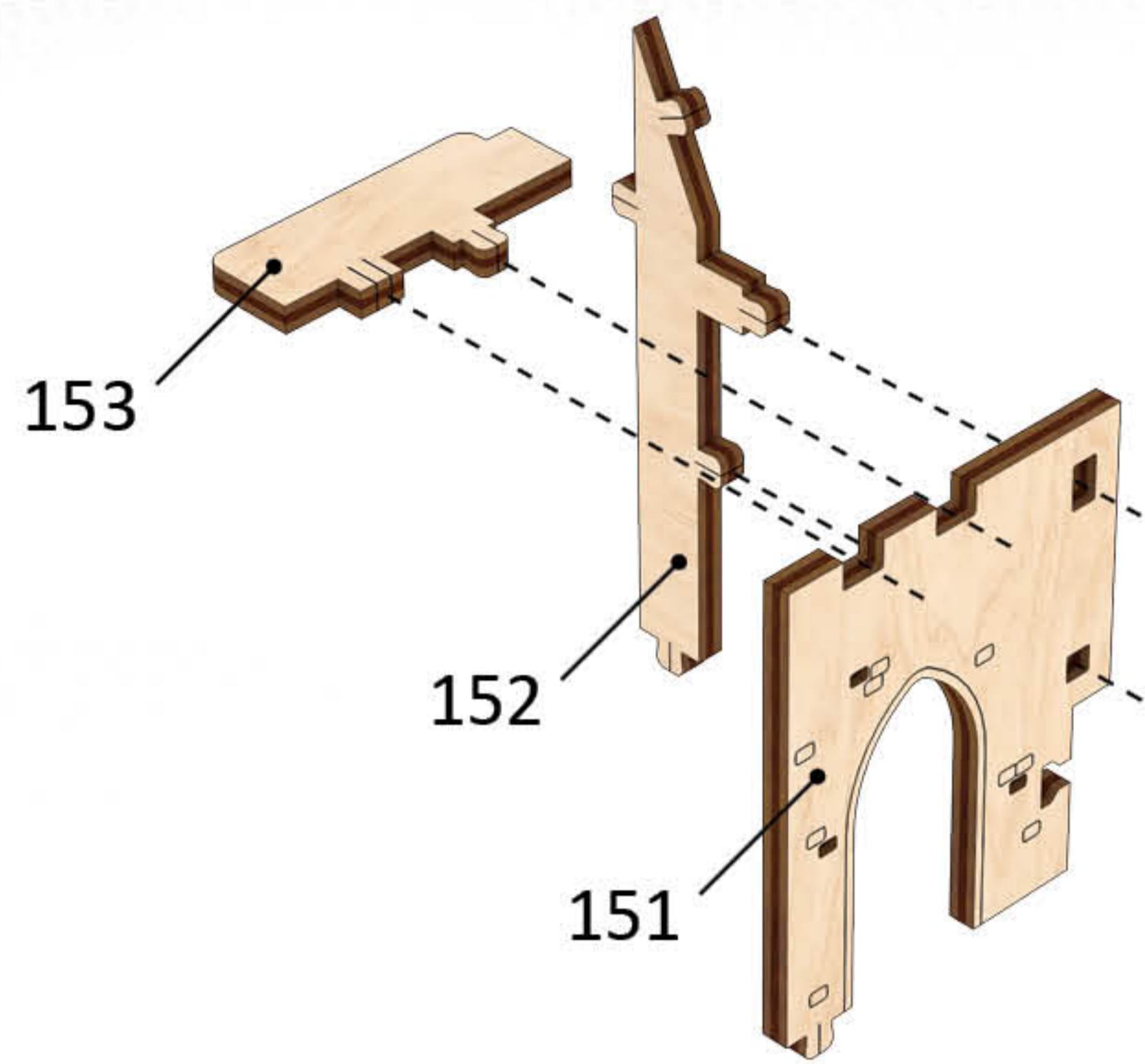

i1



1

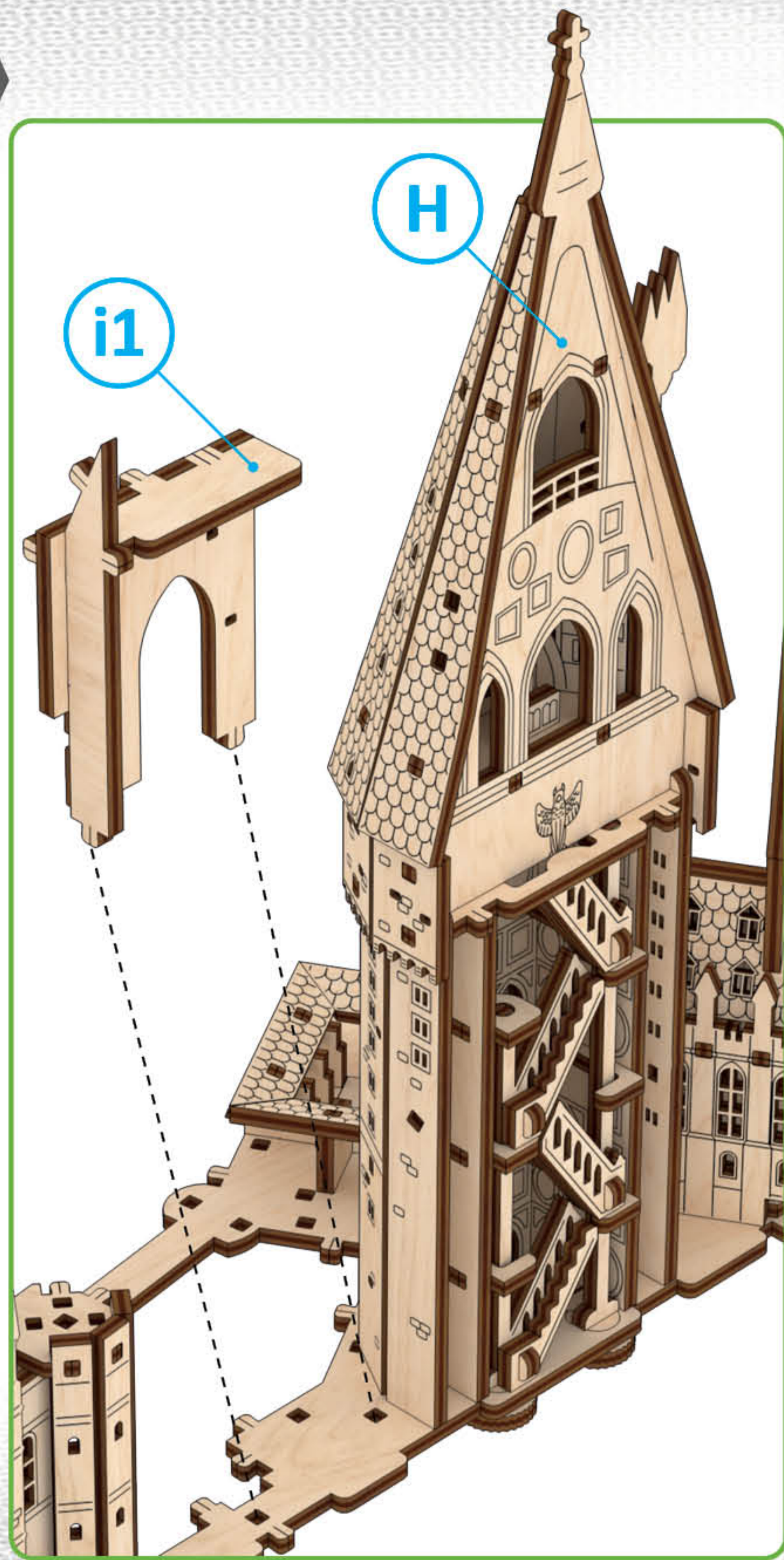

2

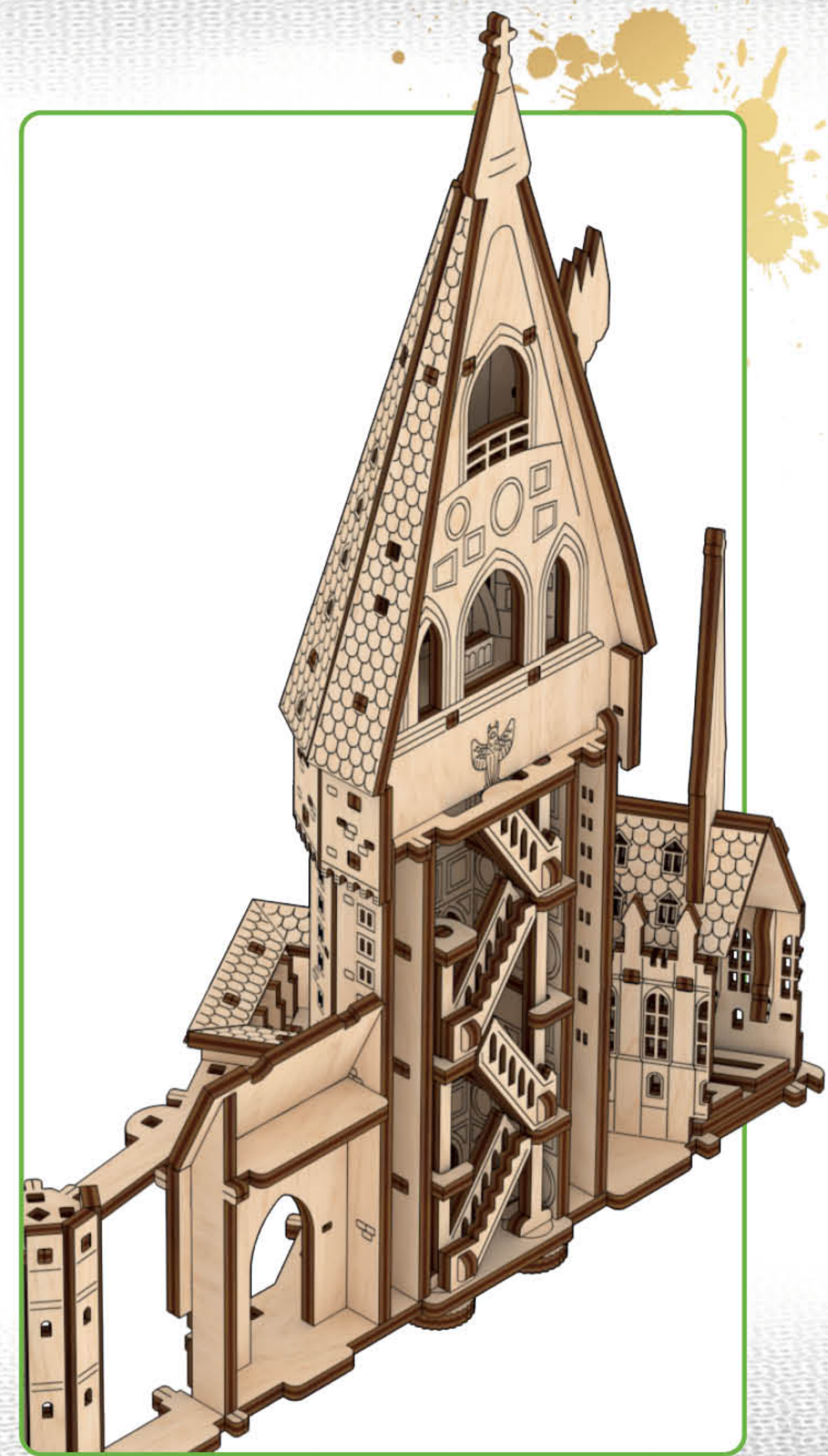
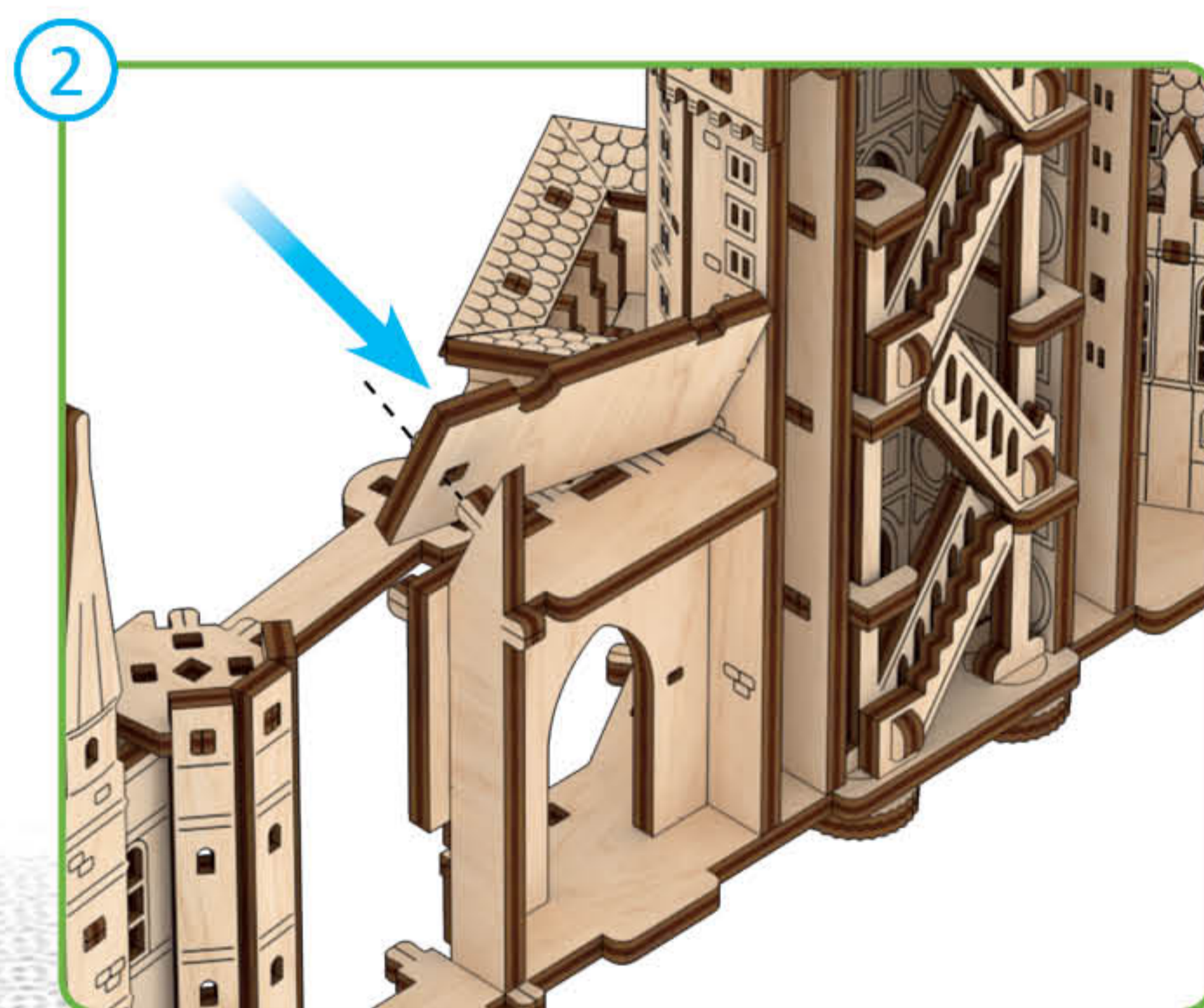
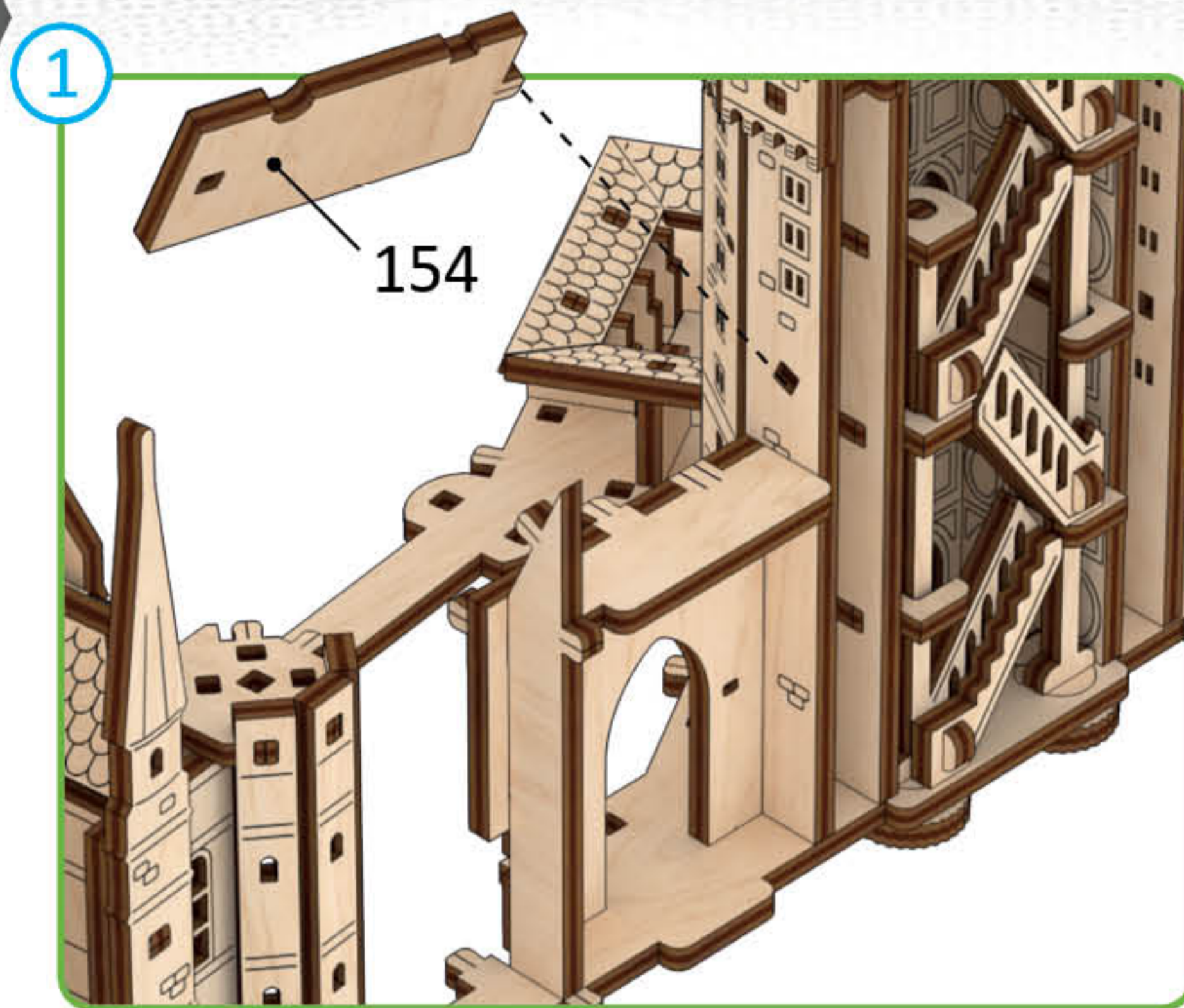

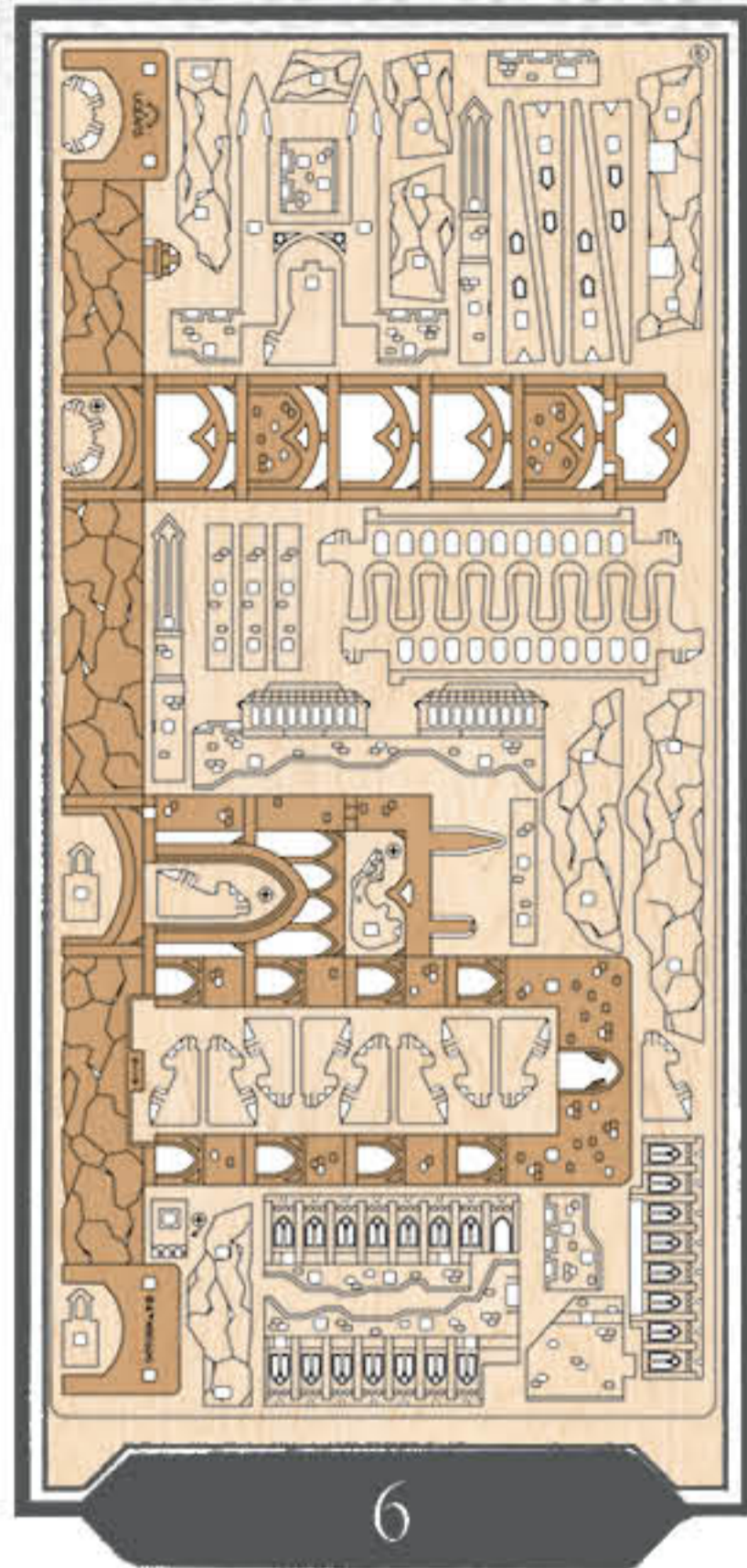

1

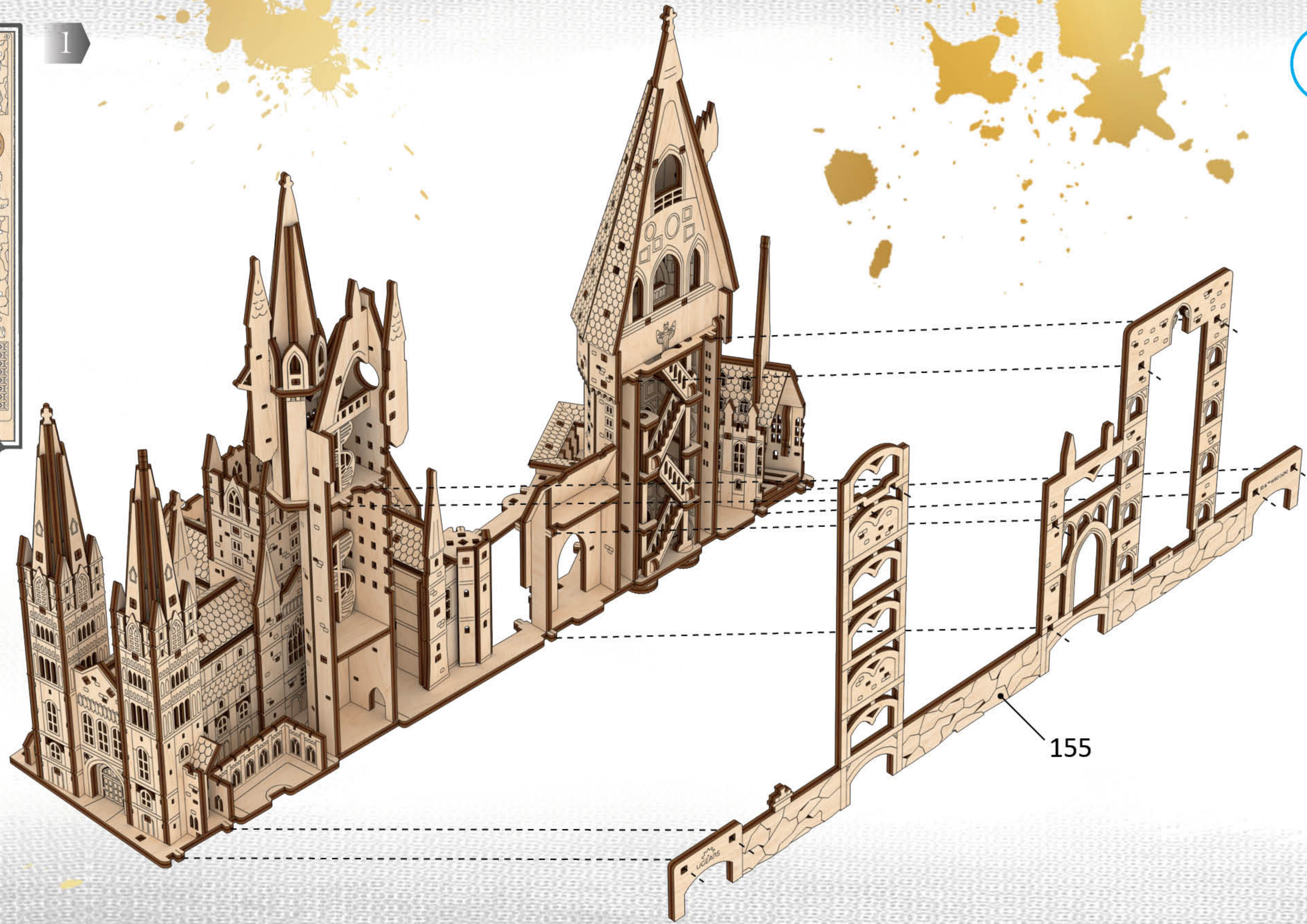

1

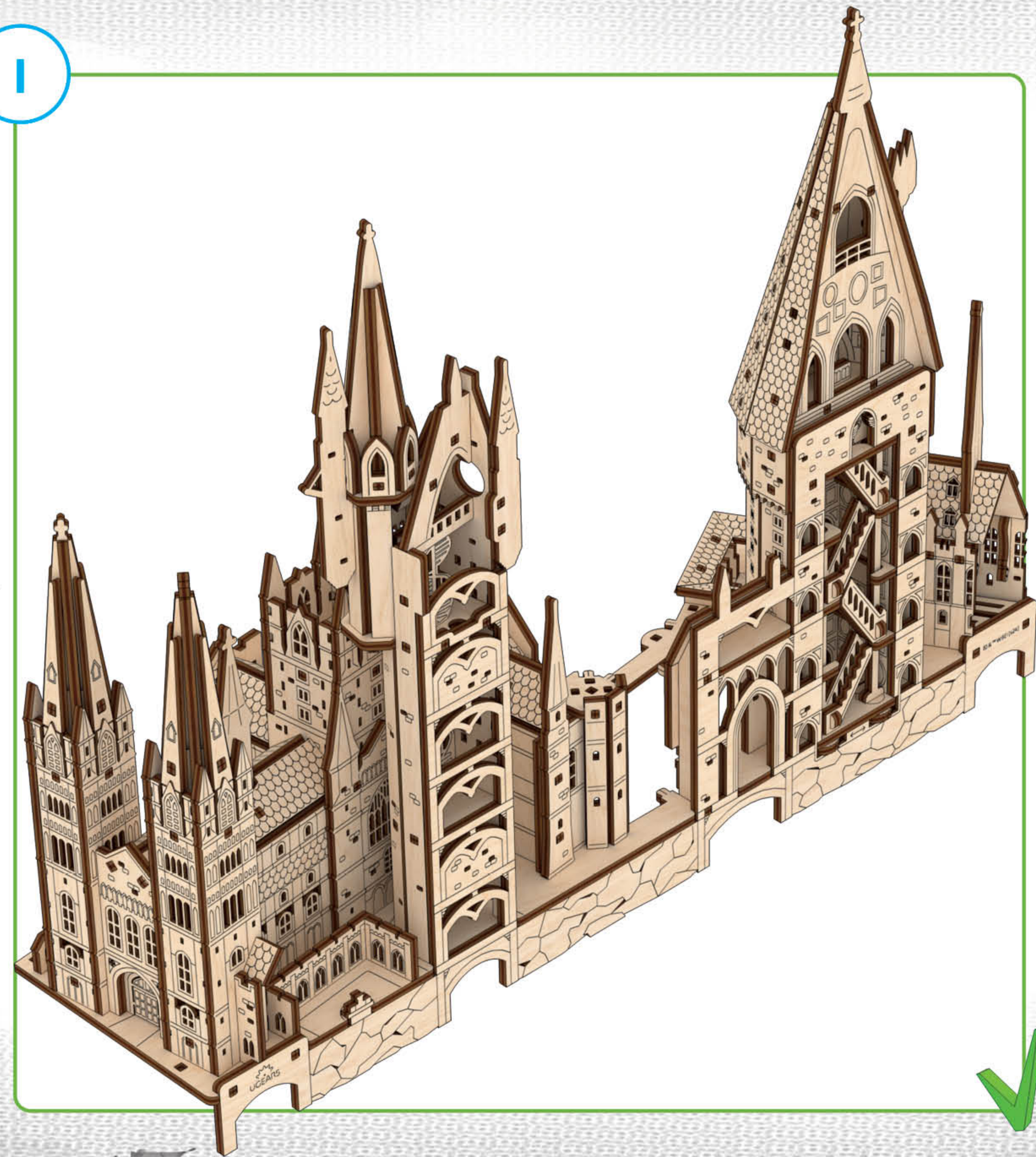

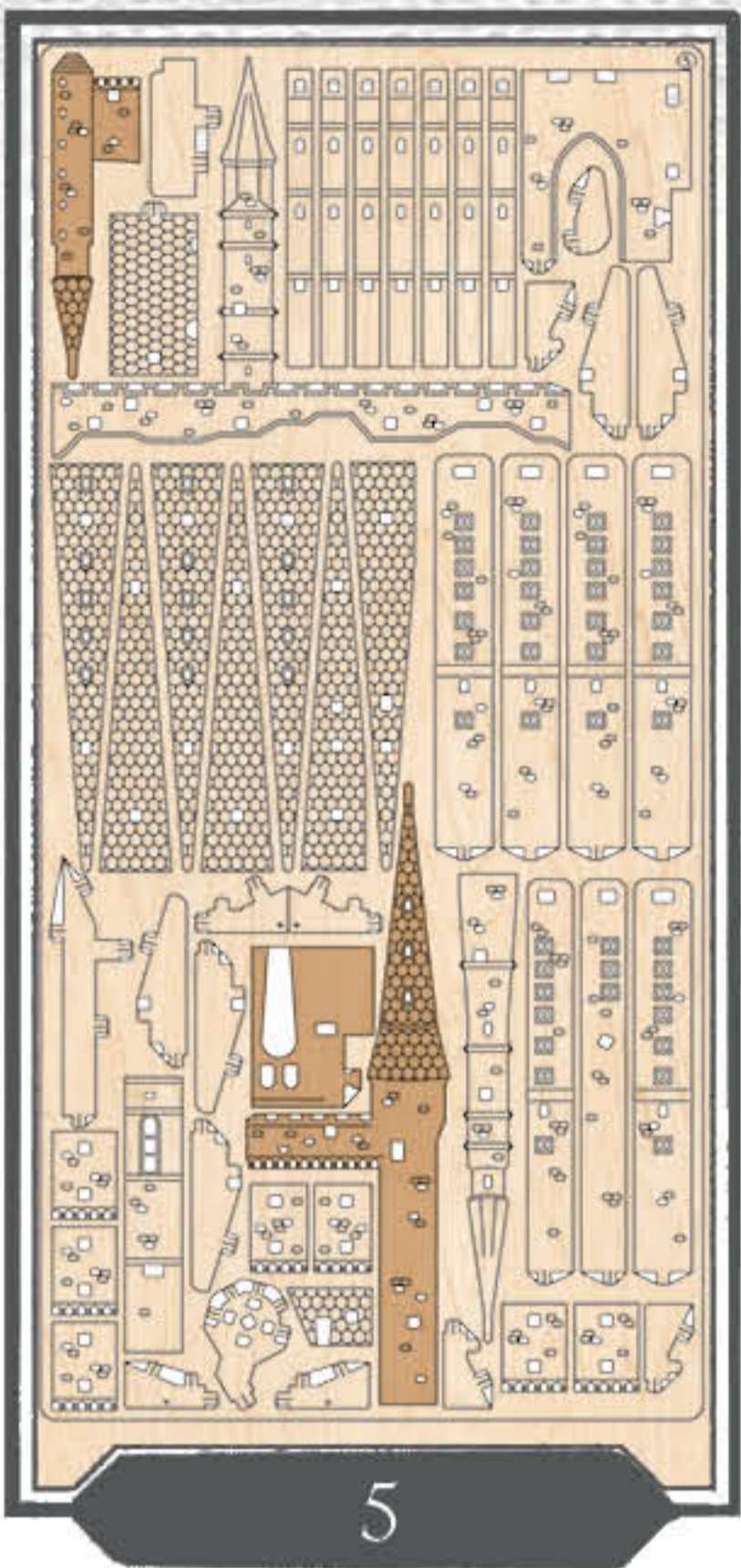

1

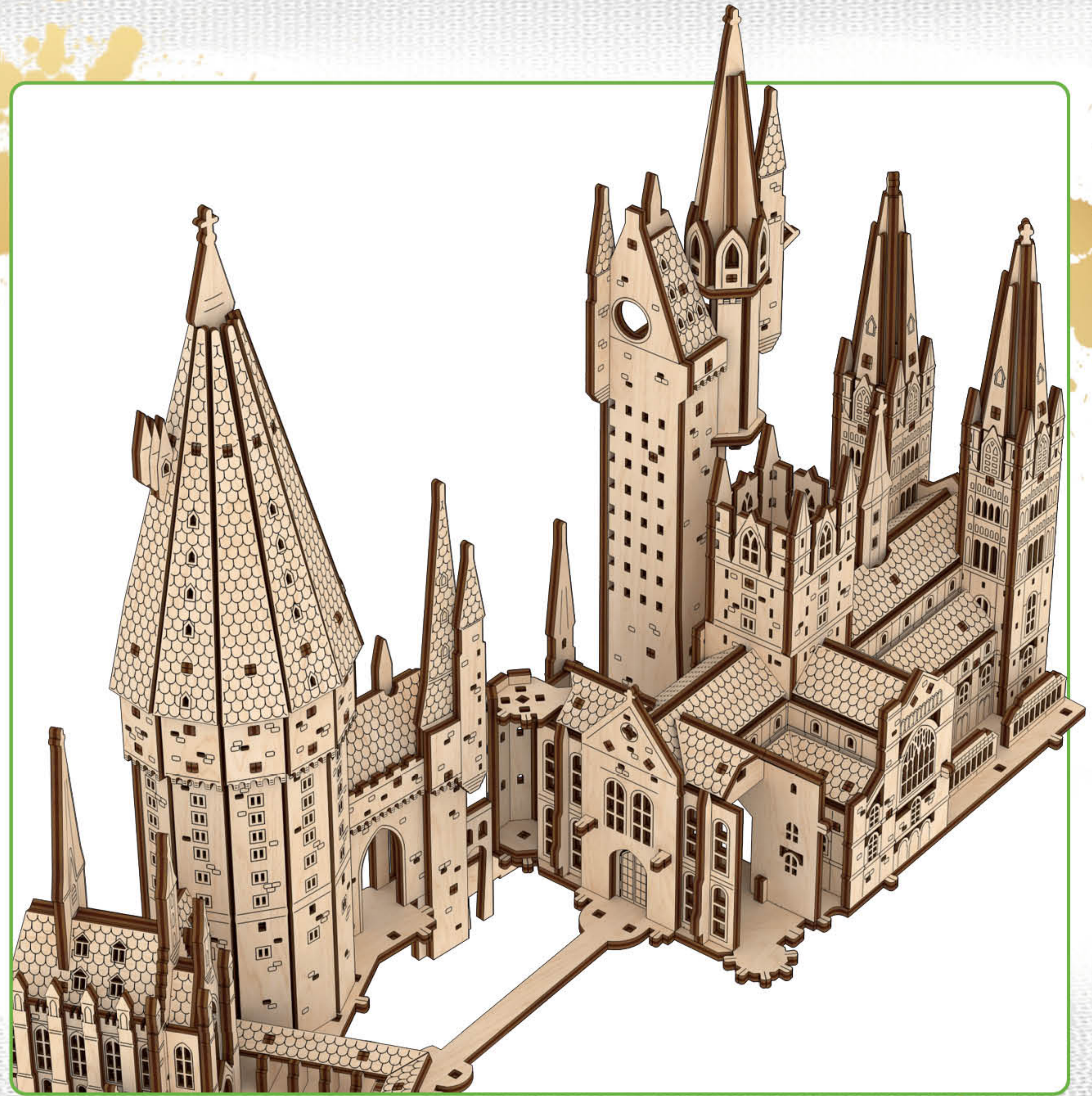
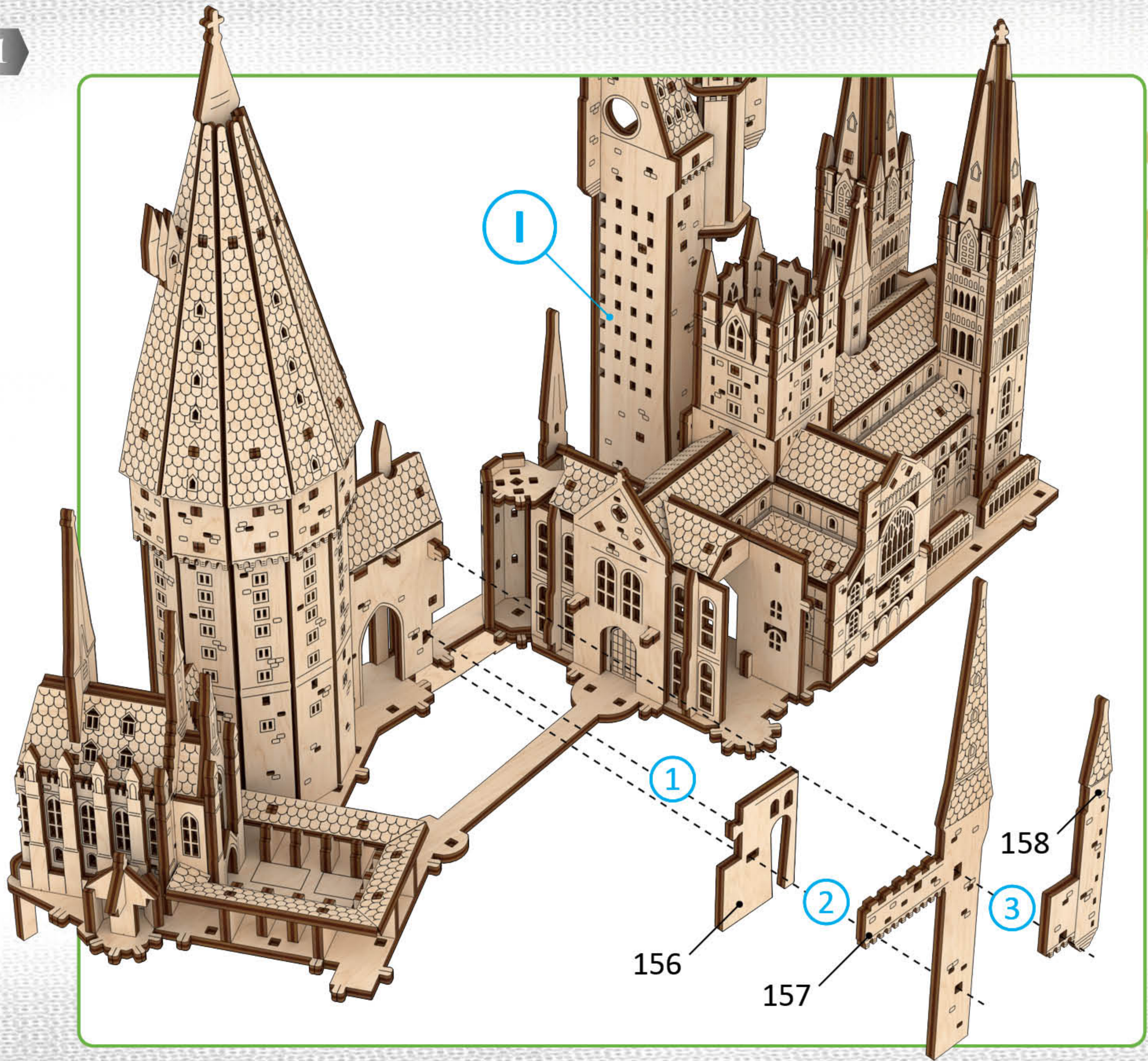

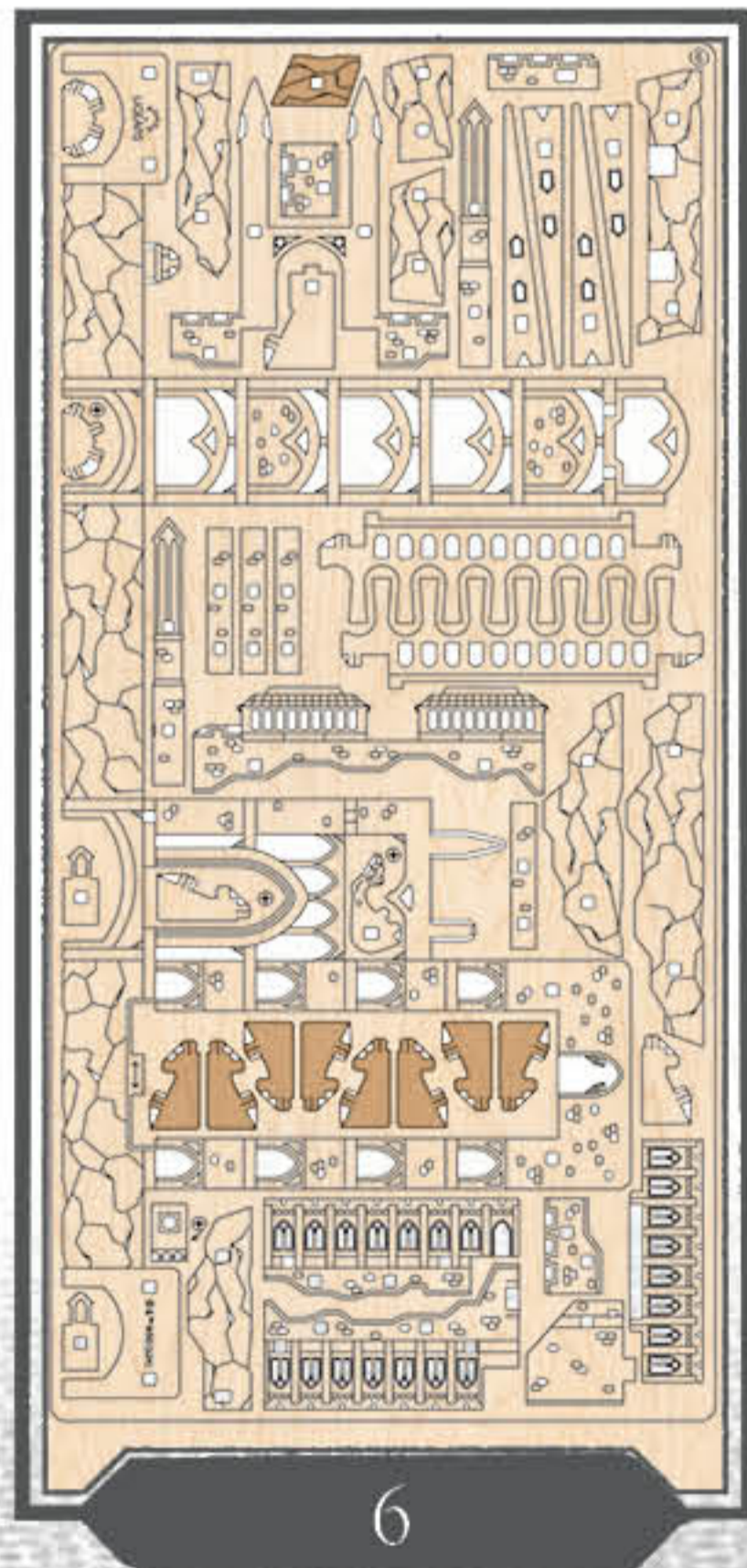
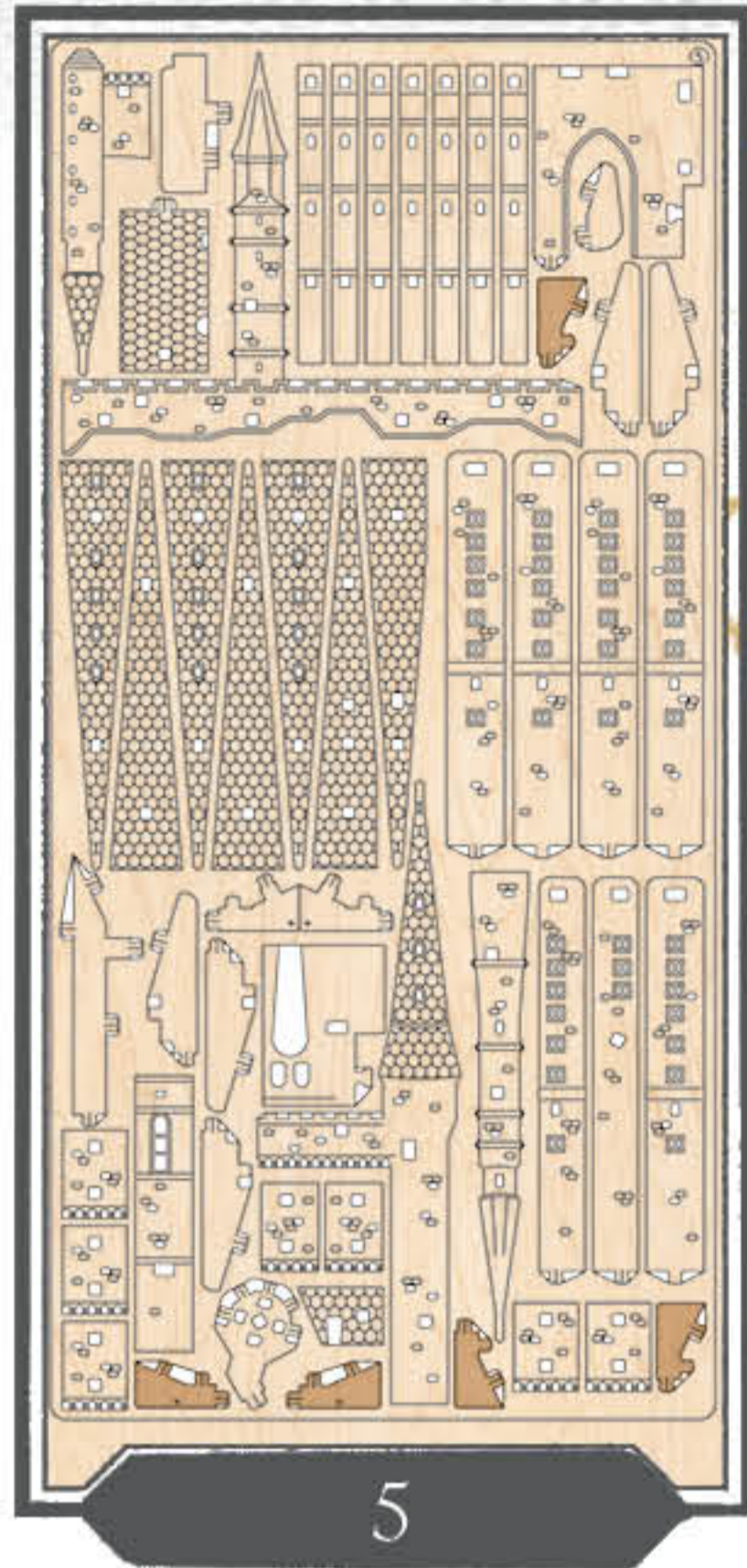

1

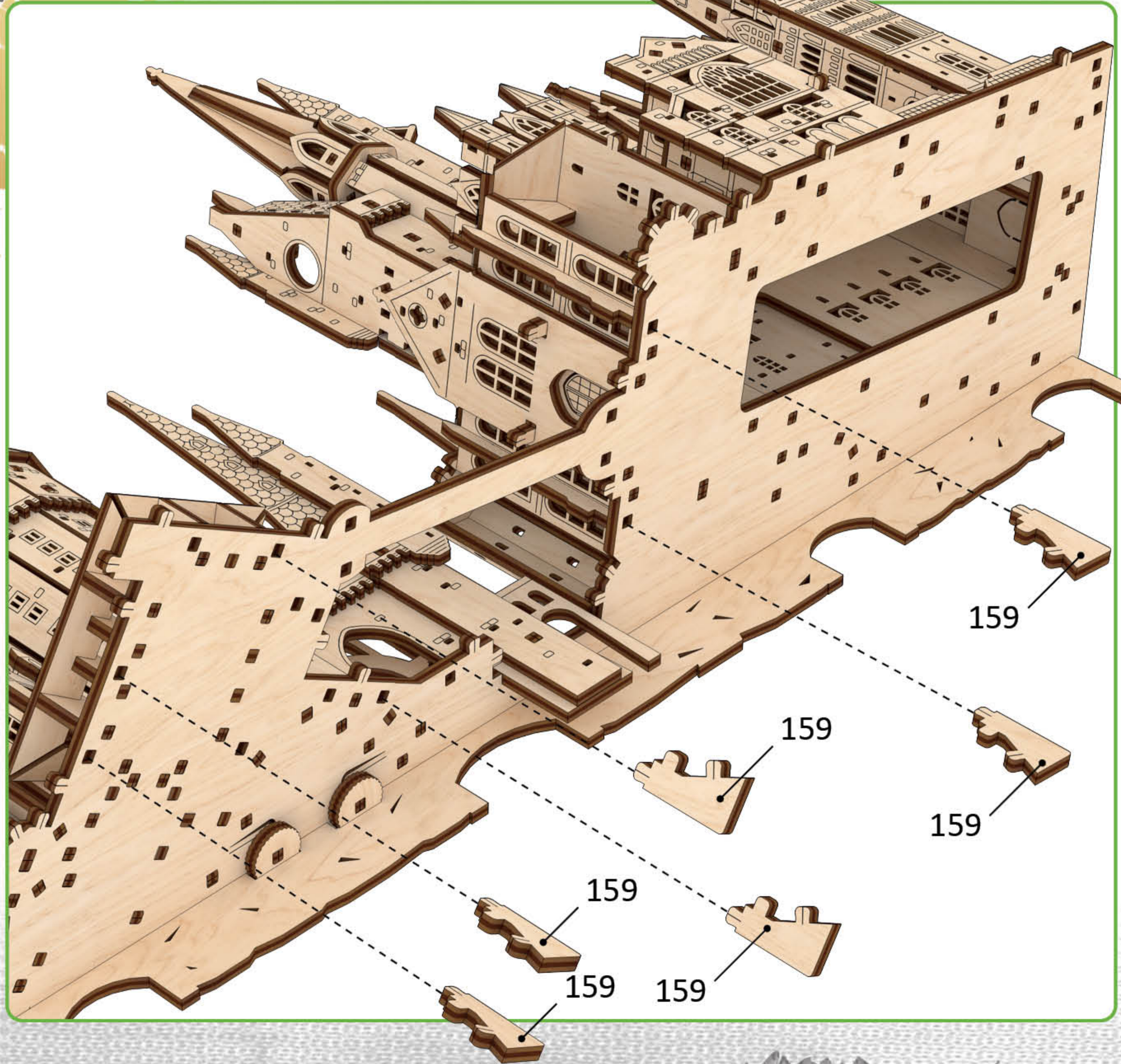

2

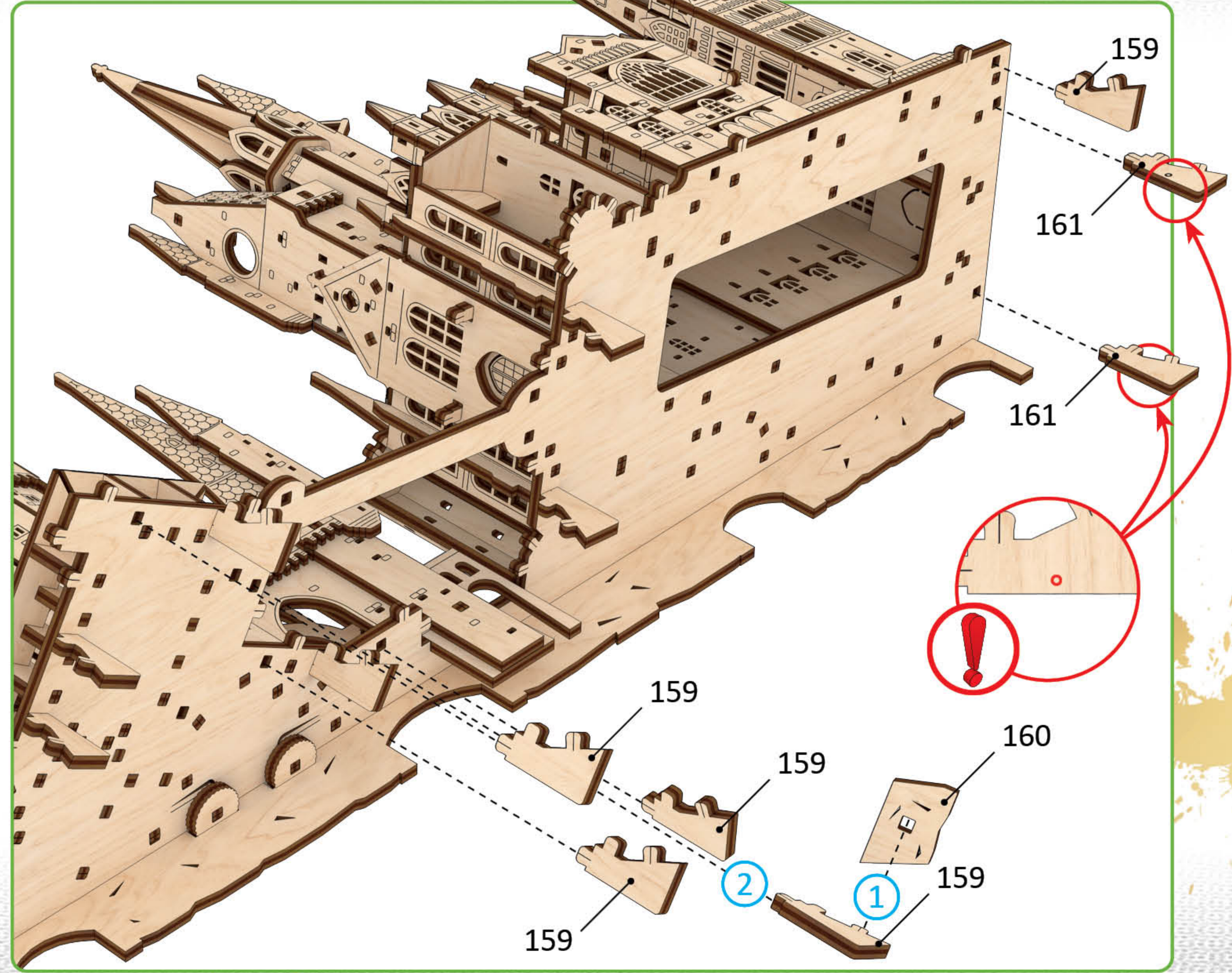

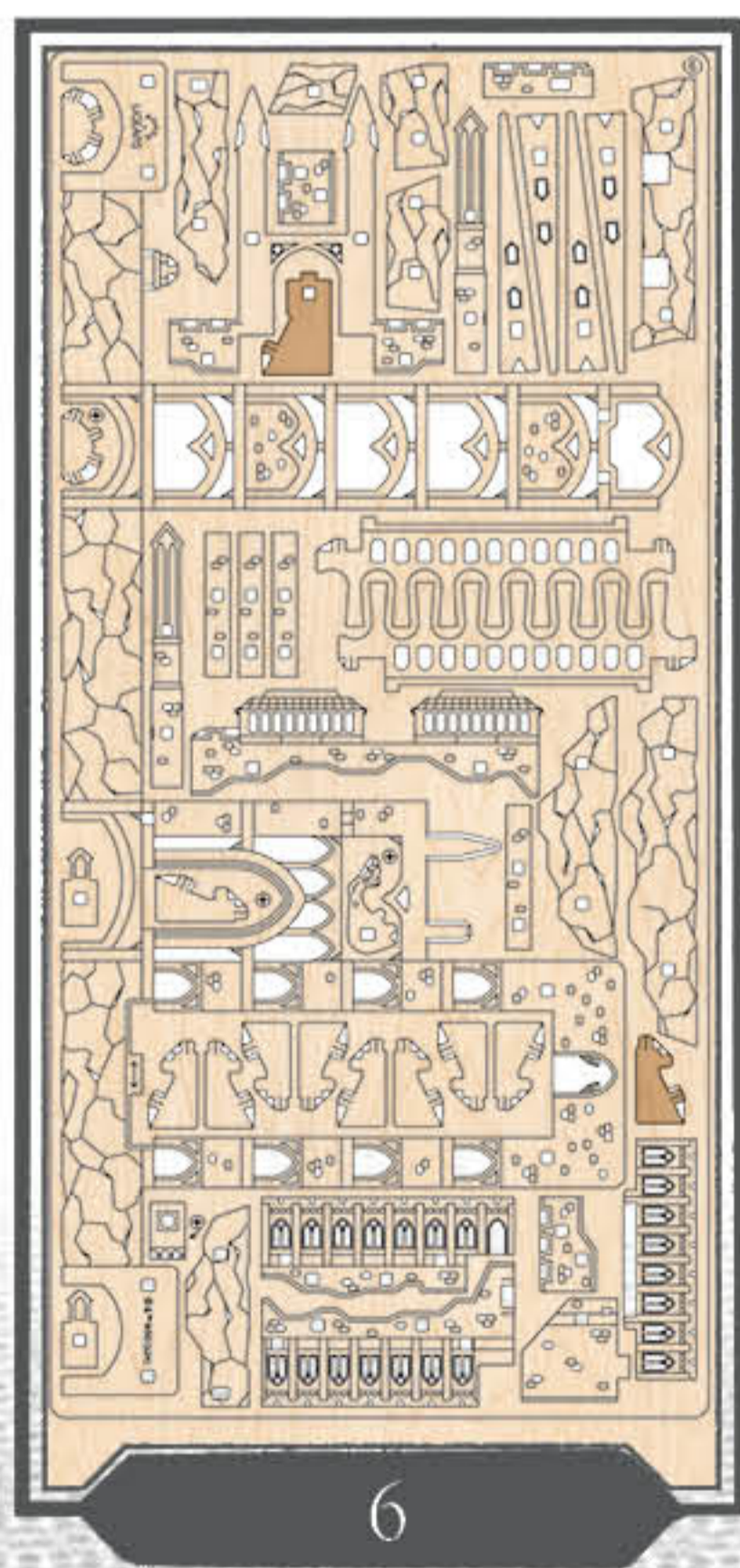
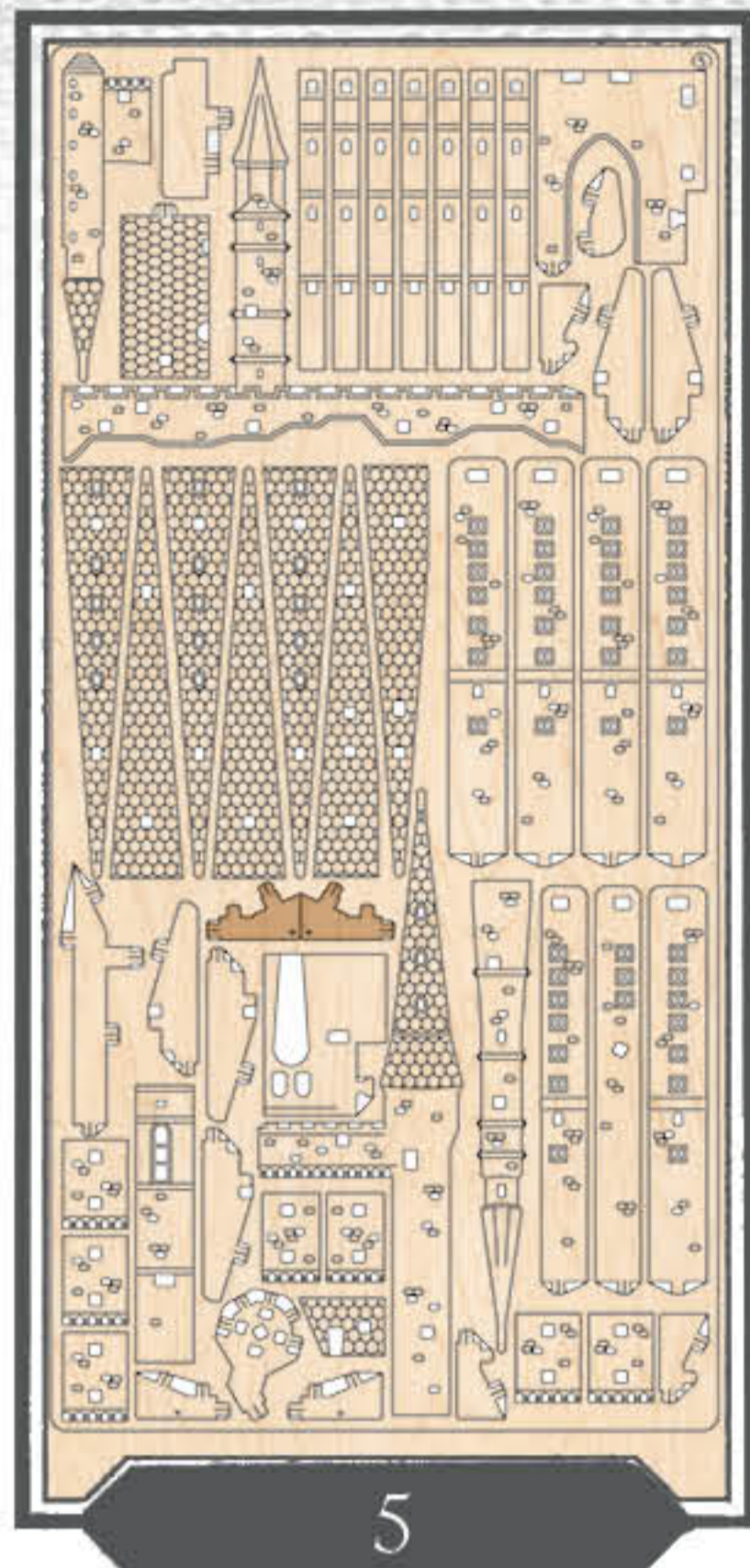

1

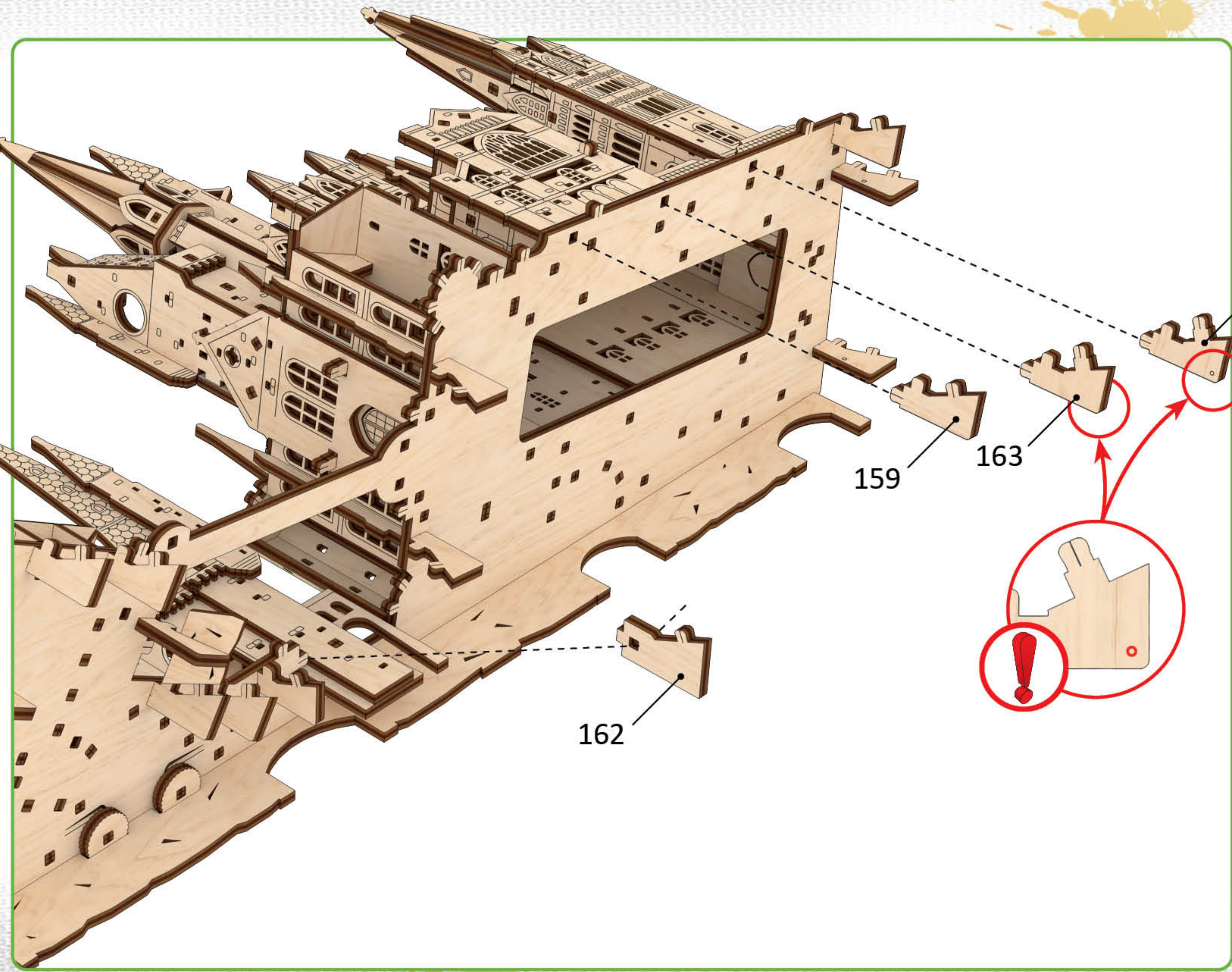

J

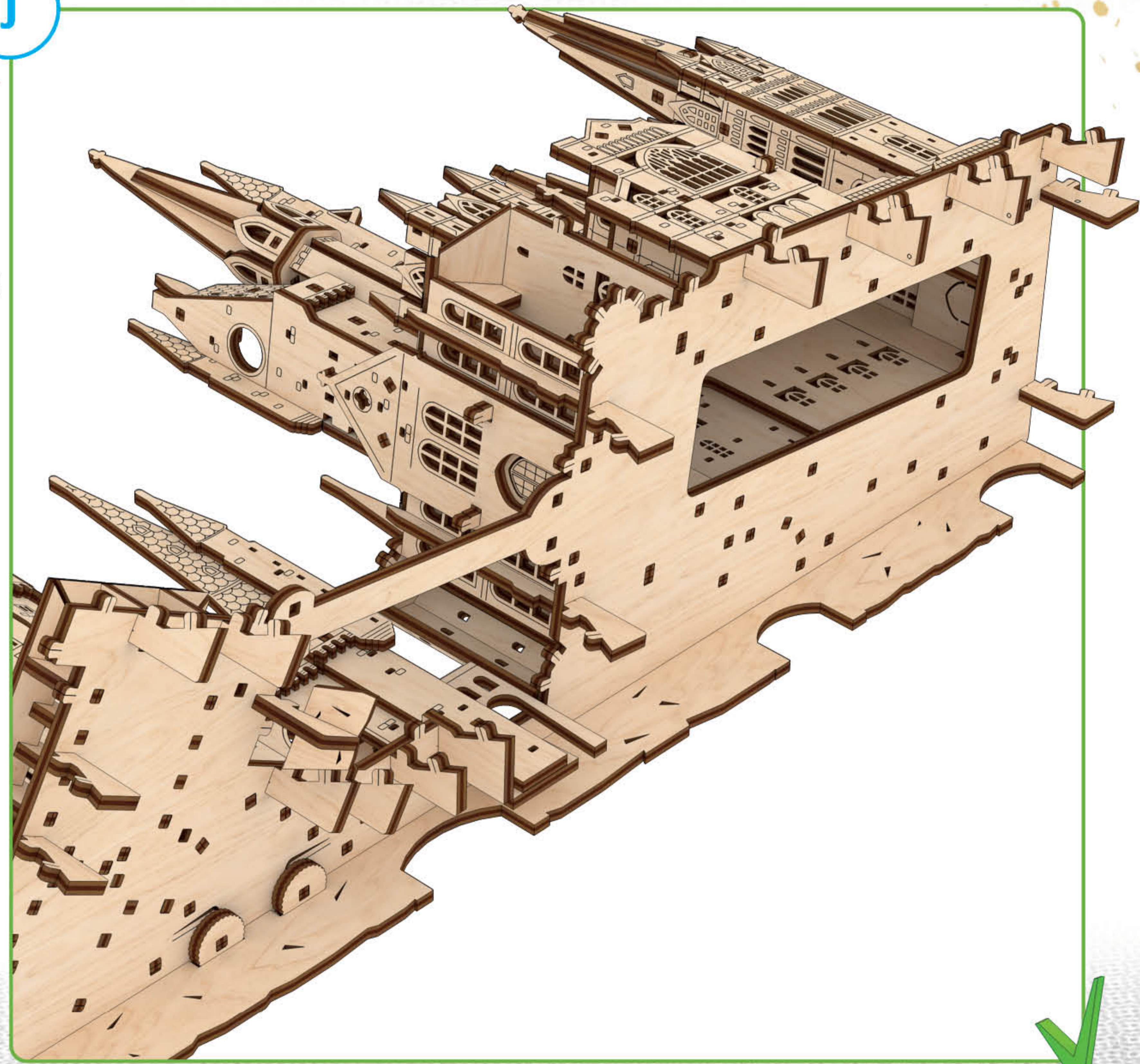

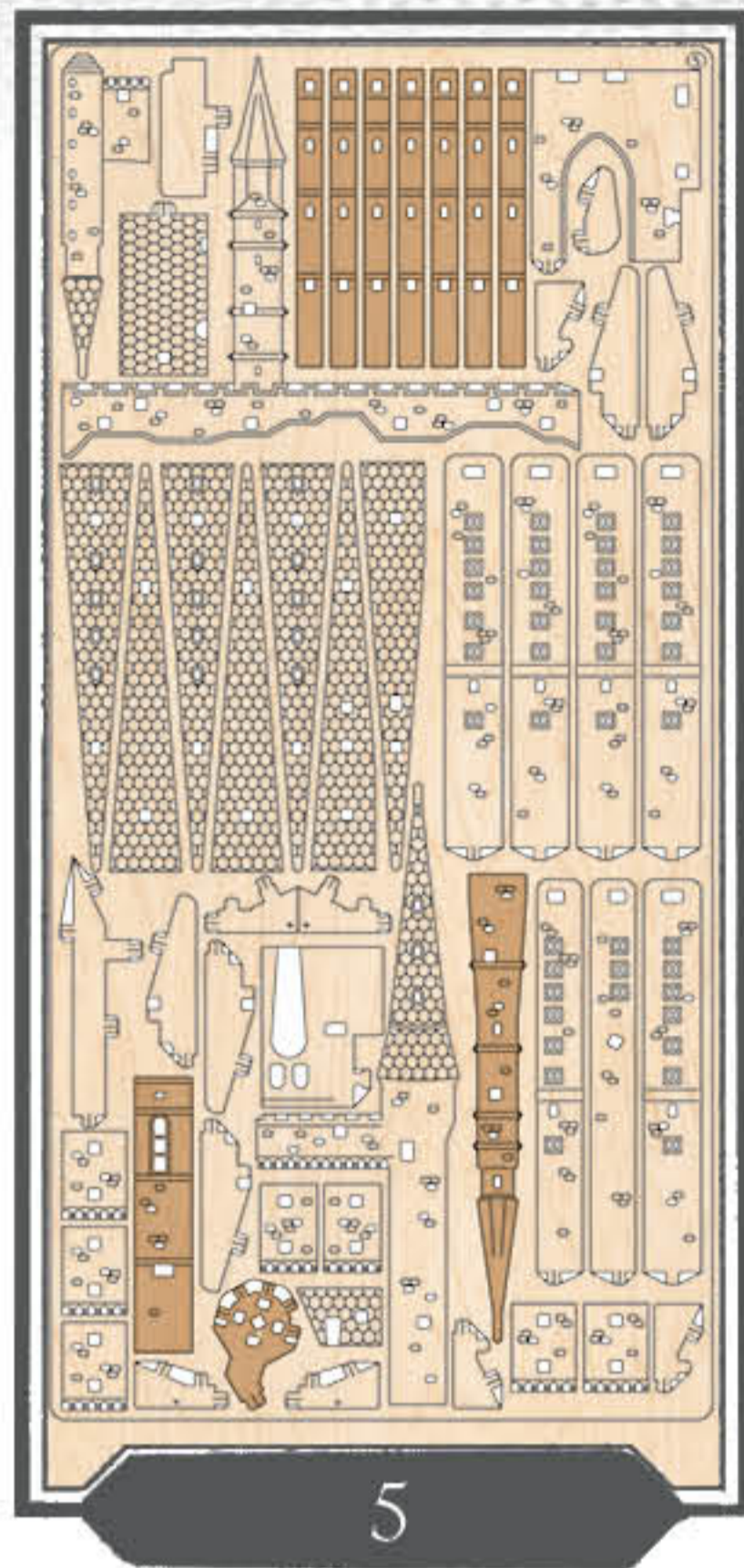

1

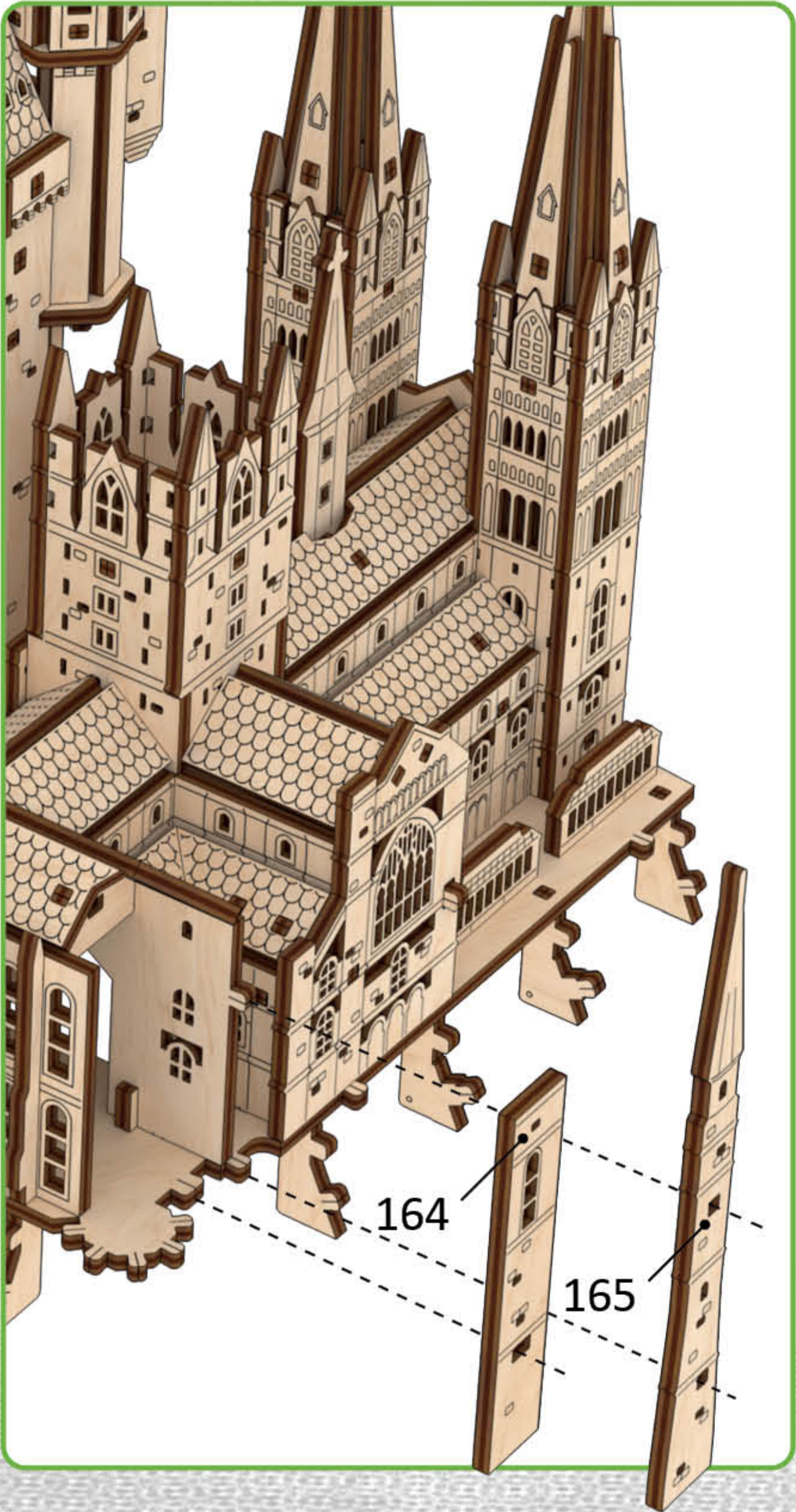

2

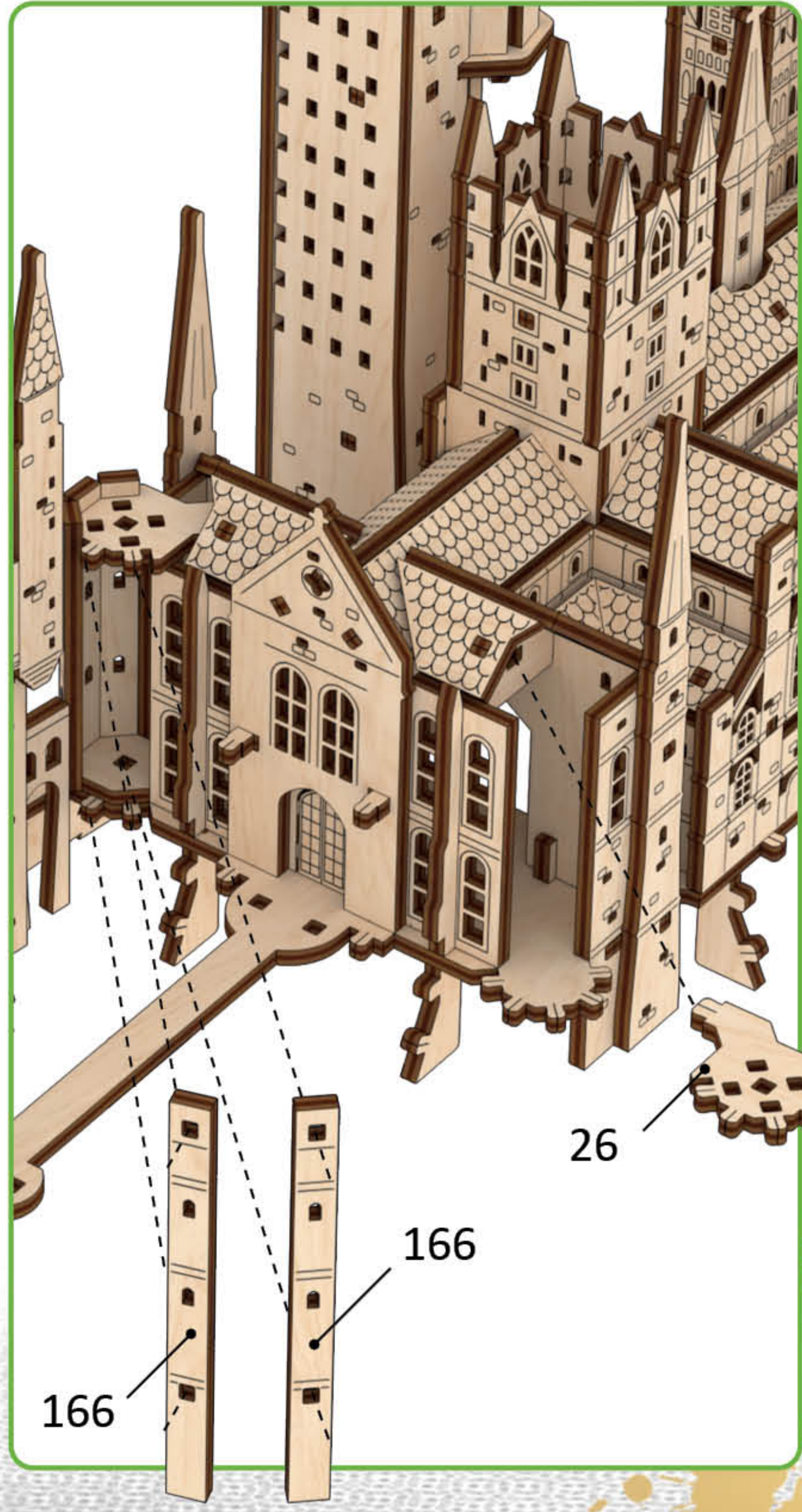

3

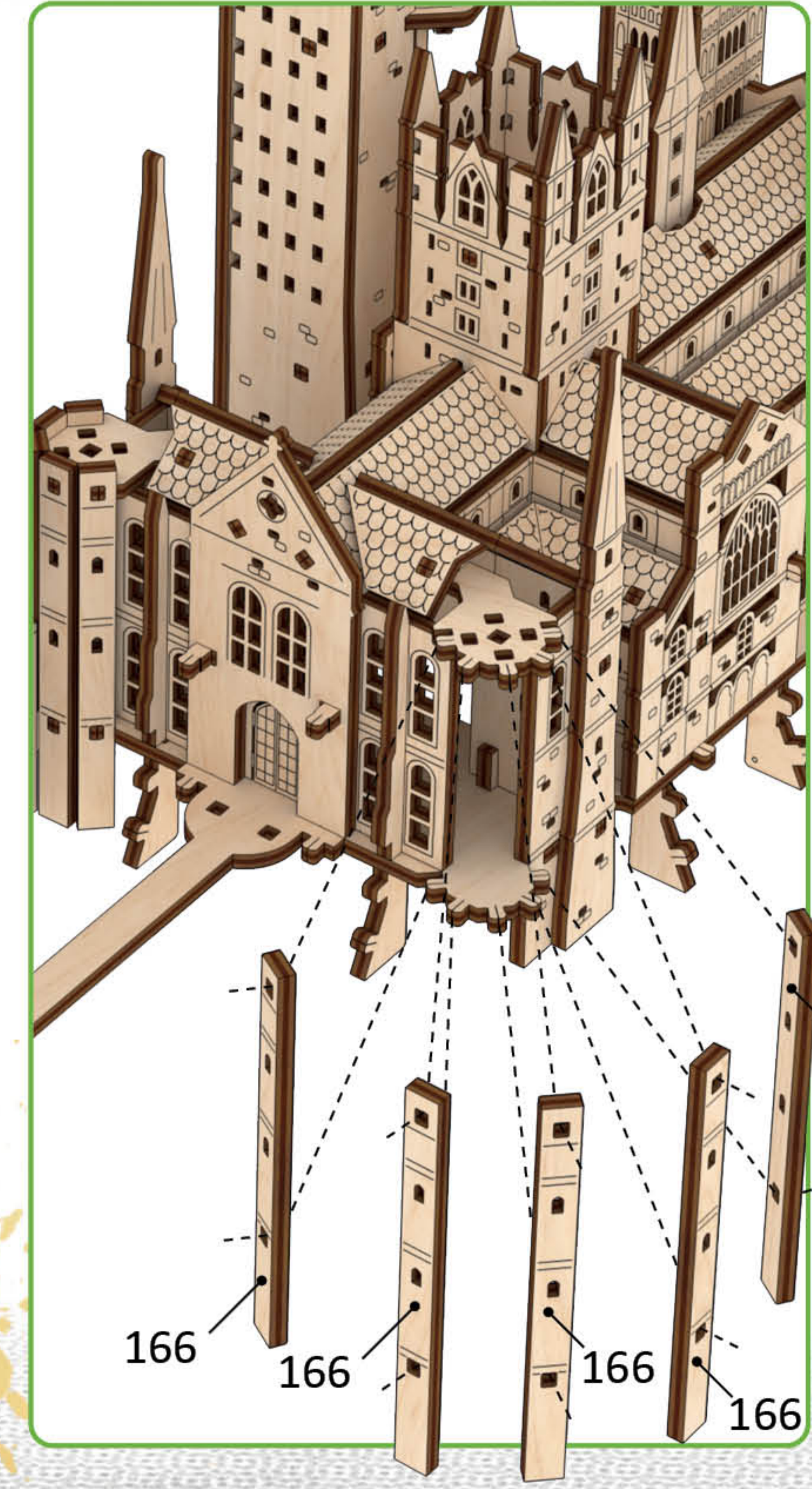

k1

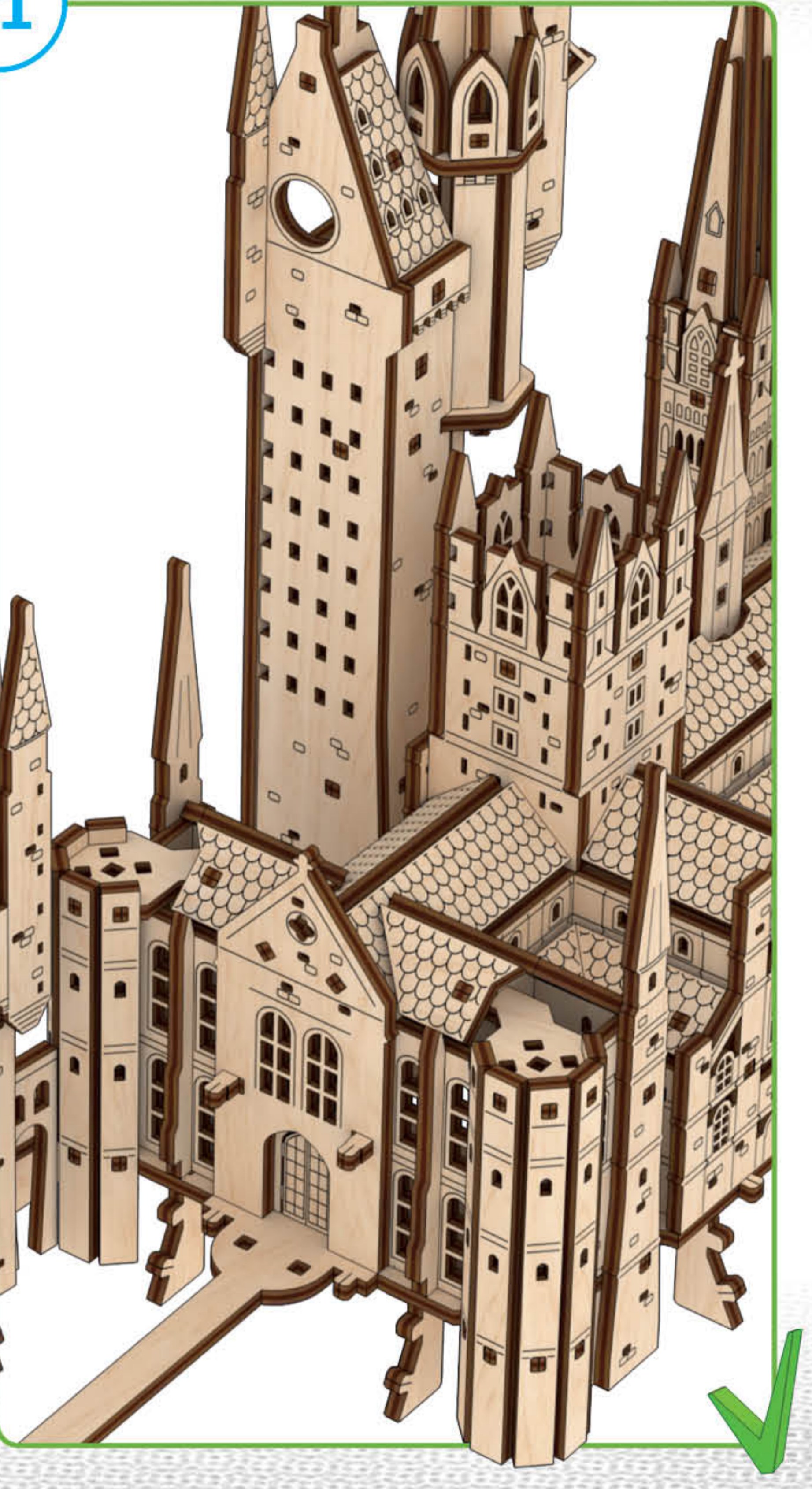

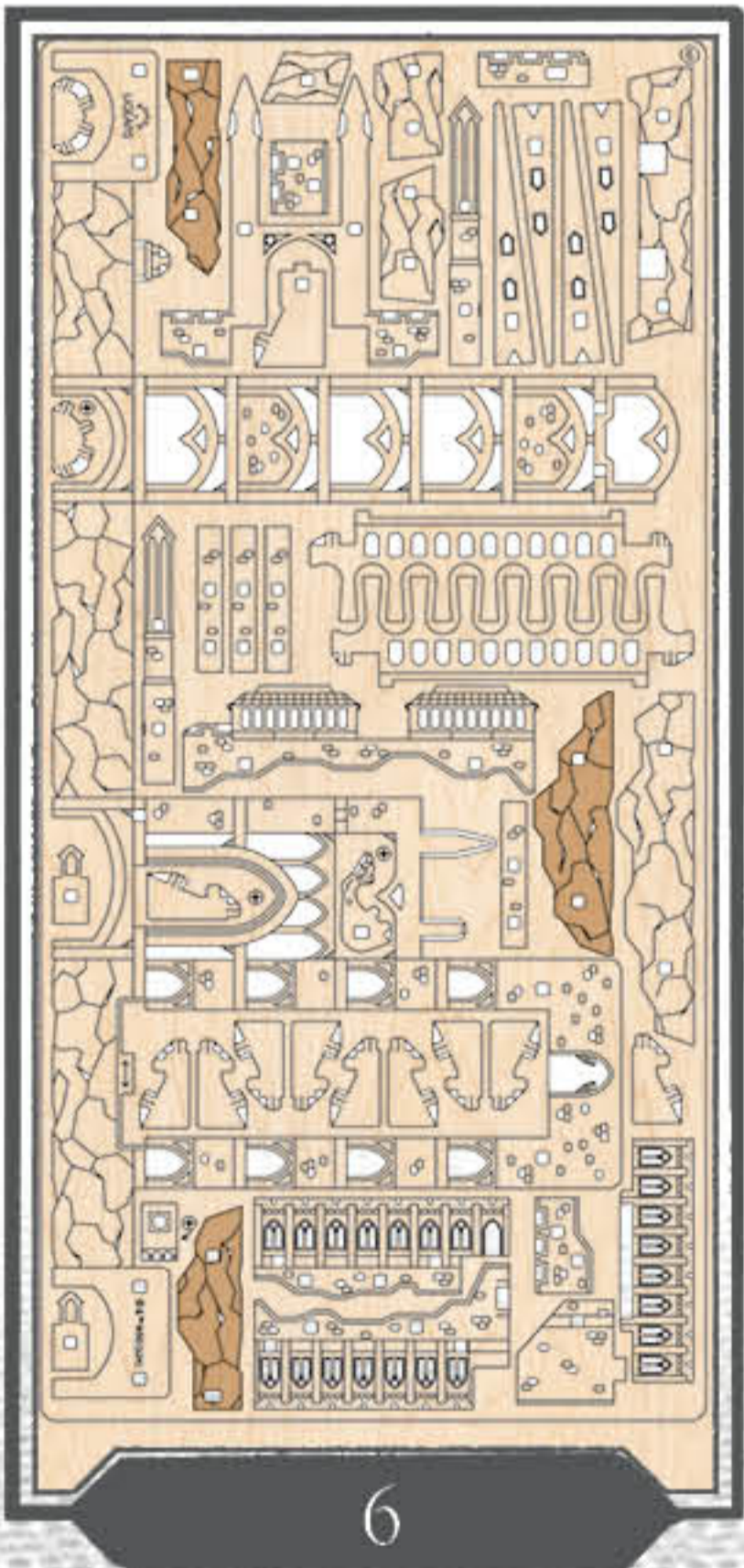
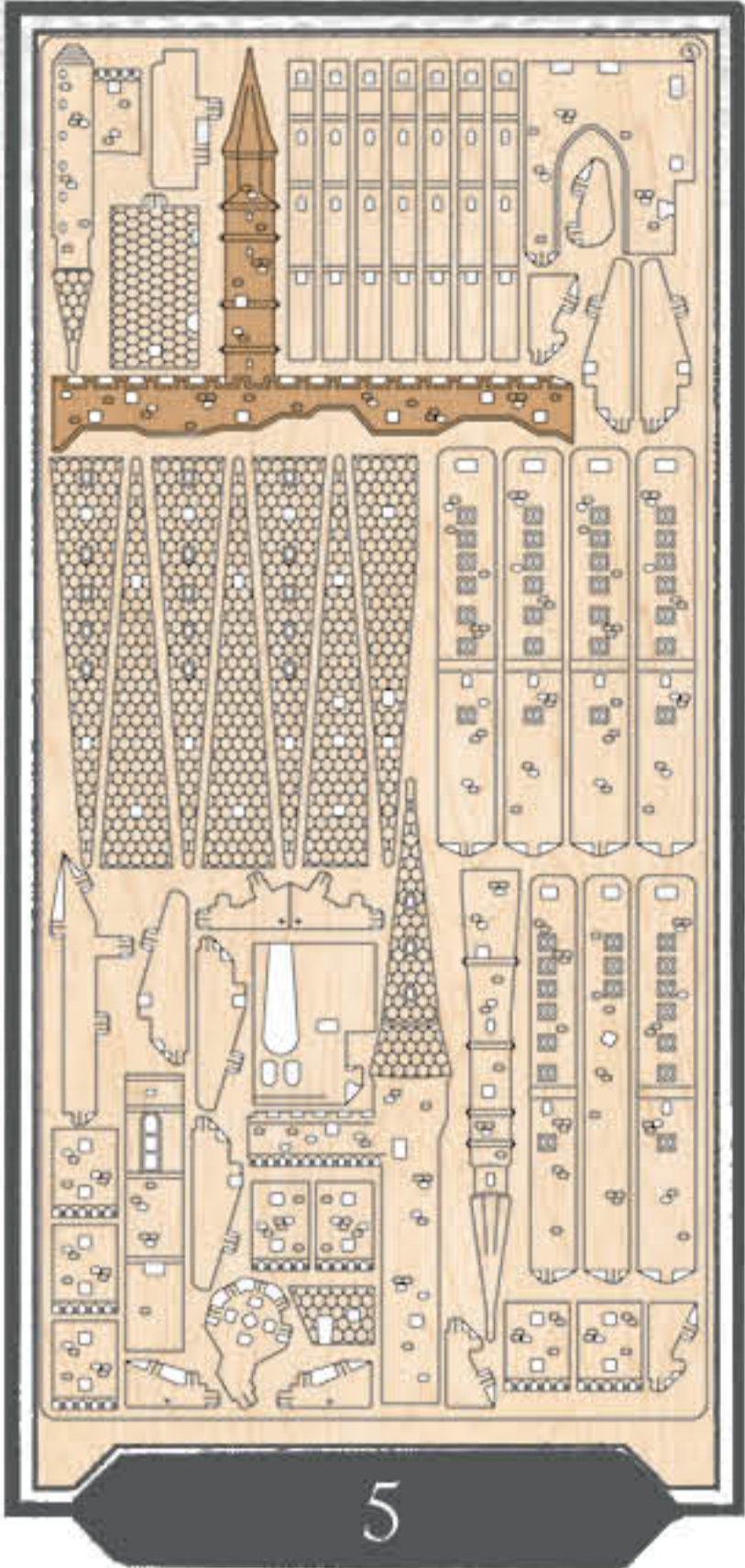

1

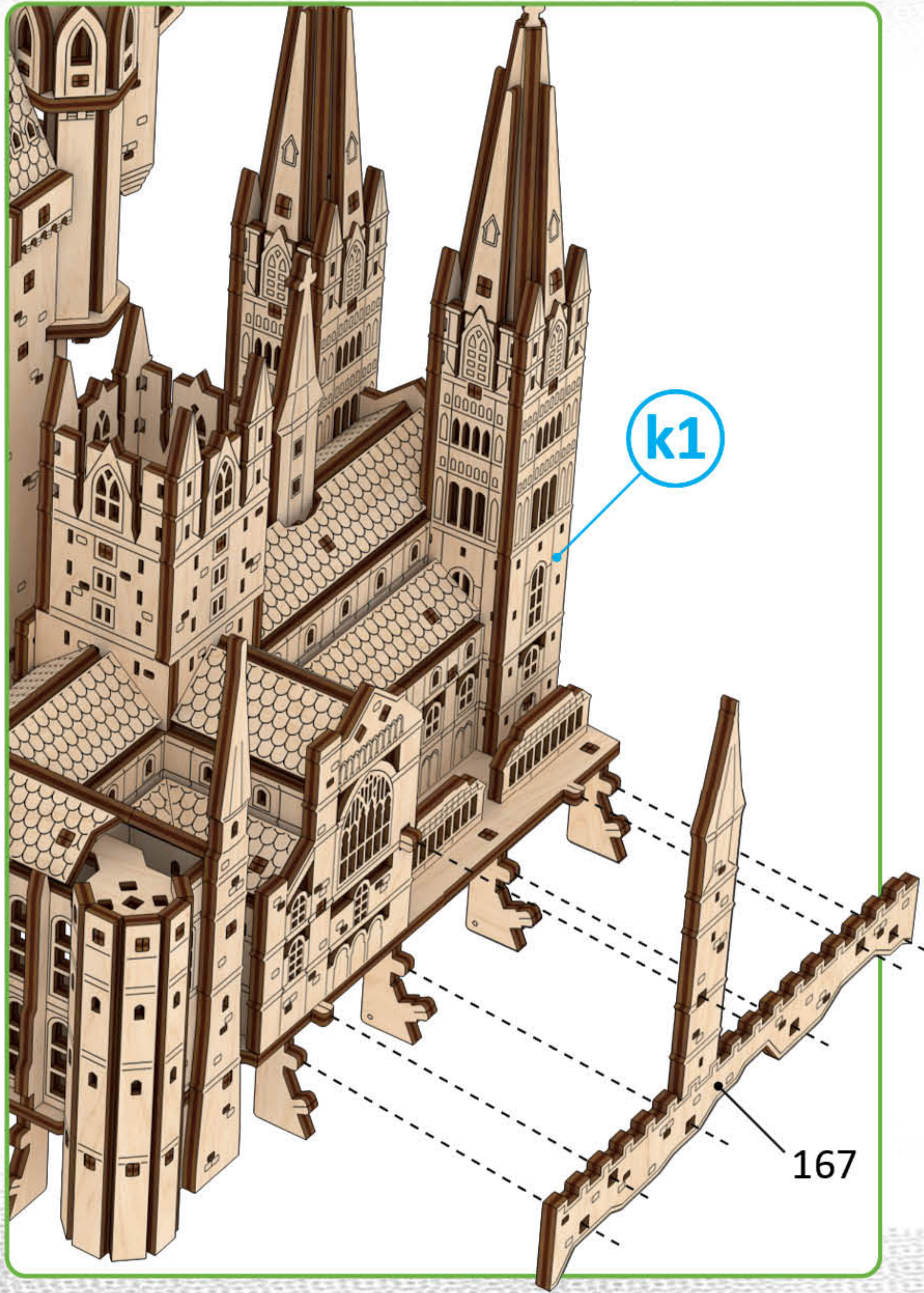

2

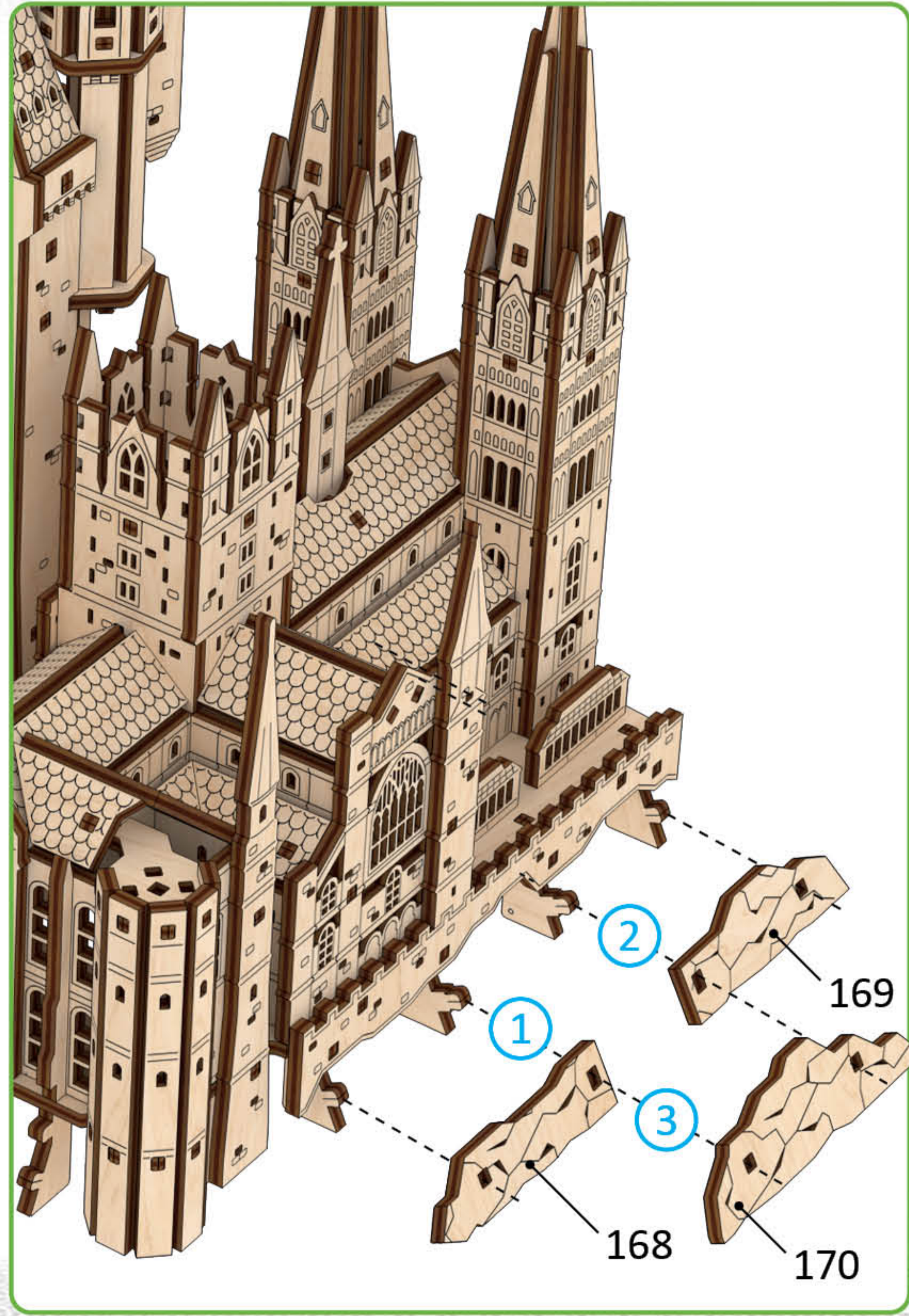

k2

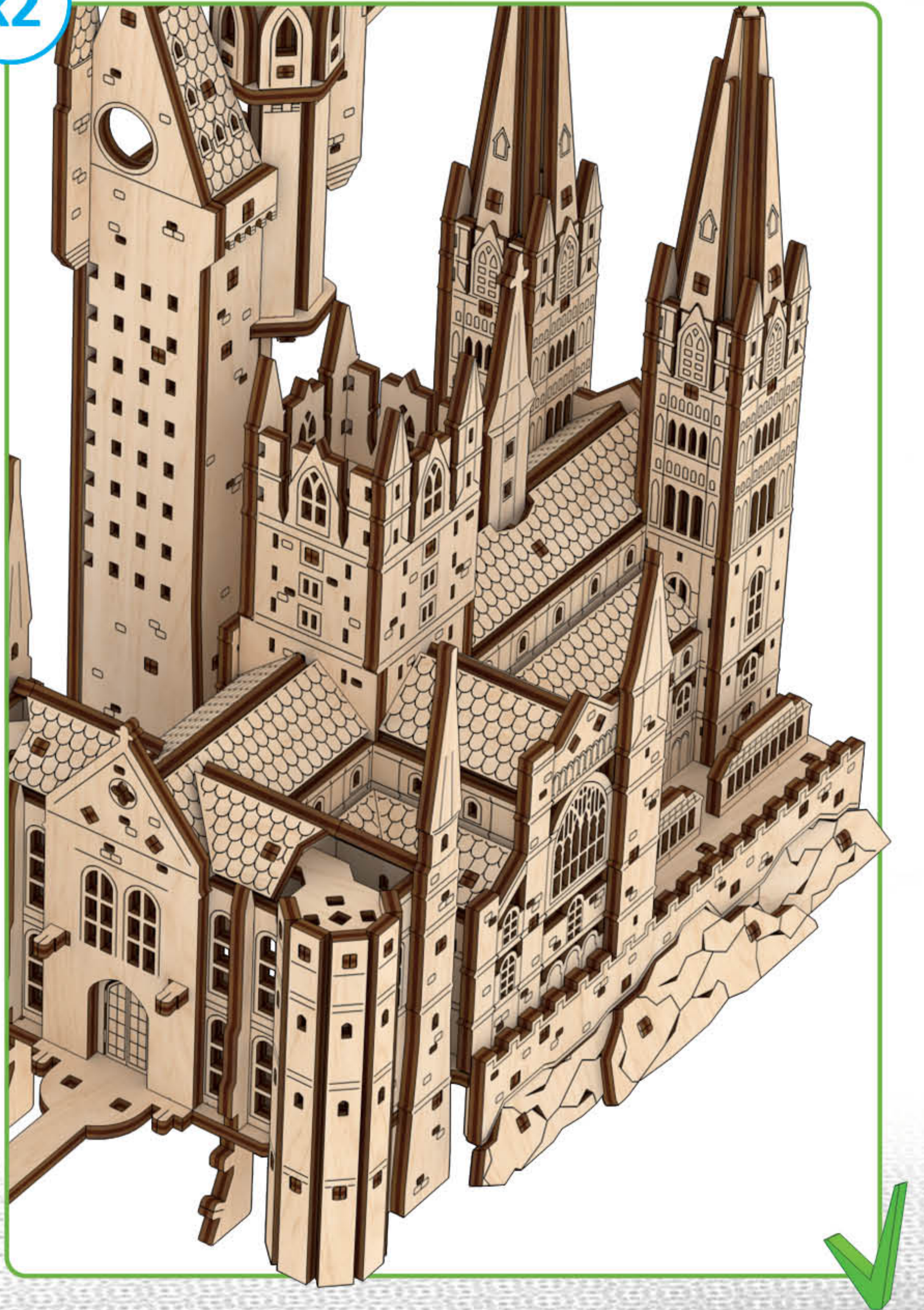

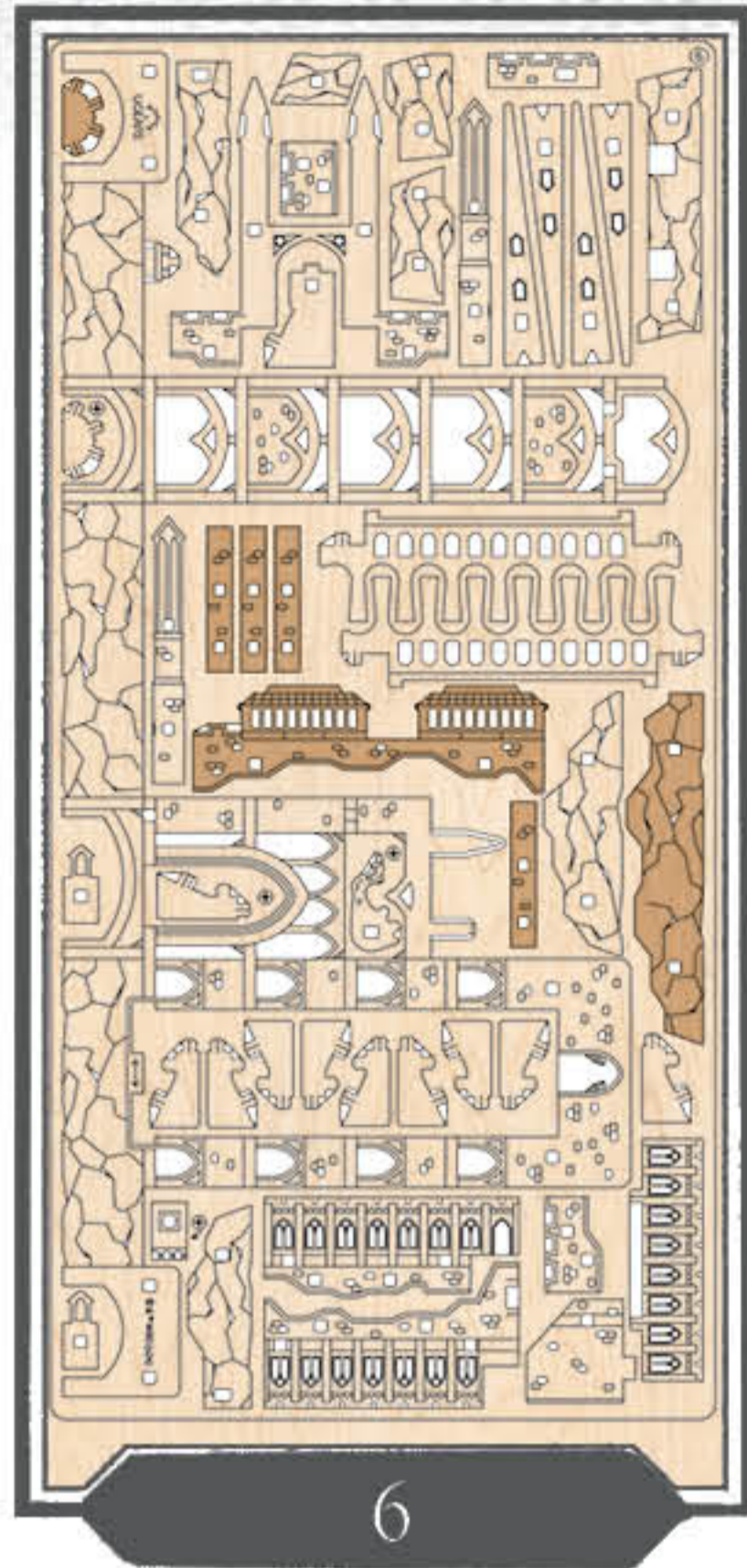

1

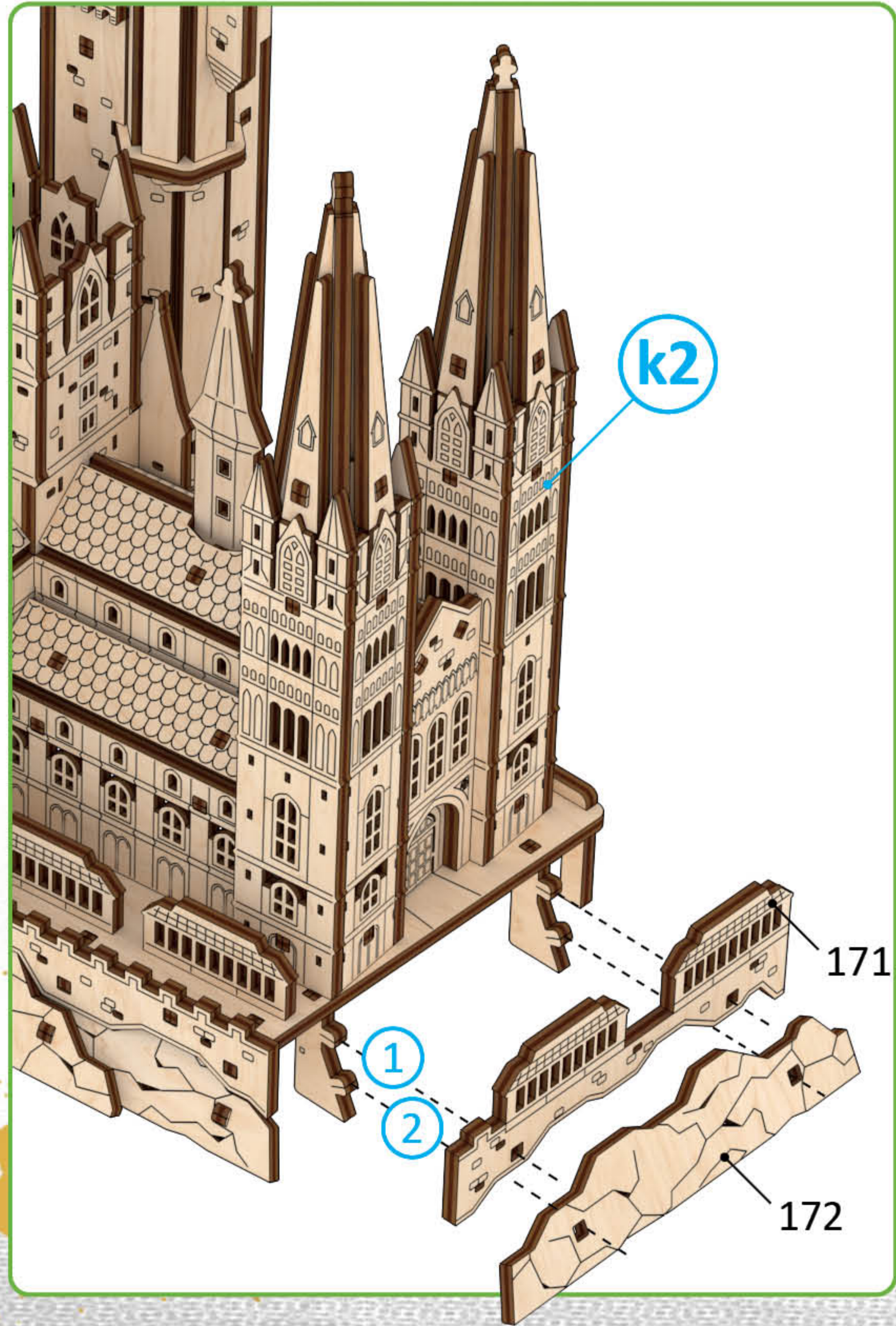

k3

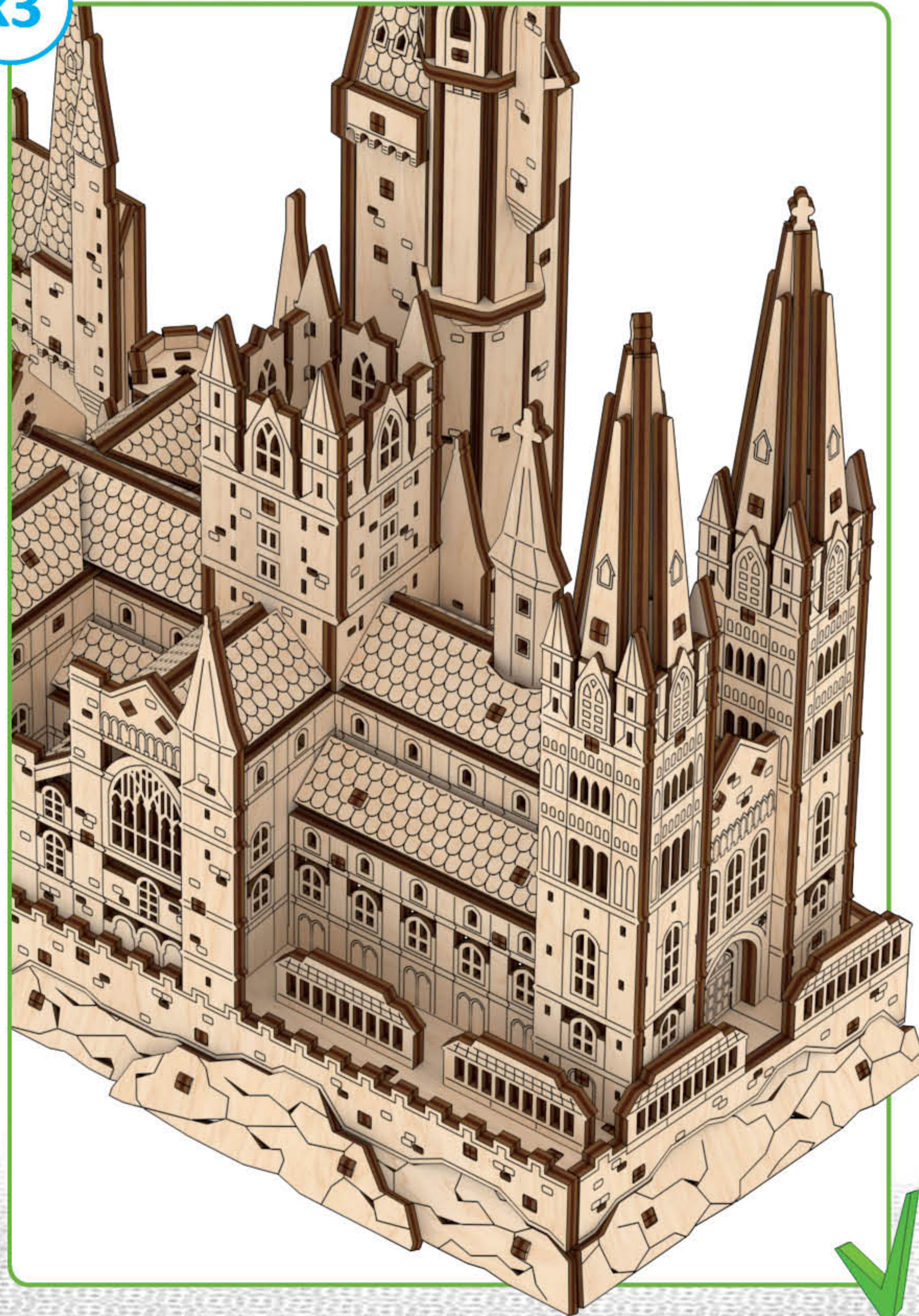

1

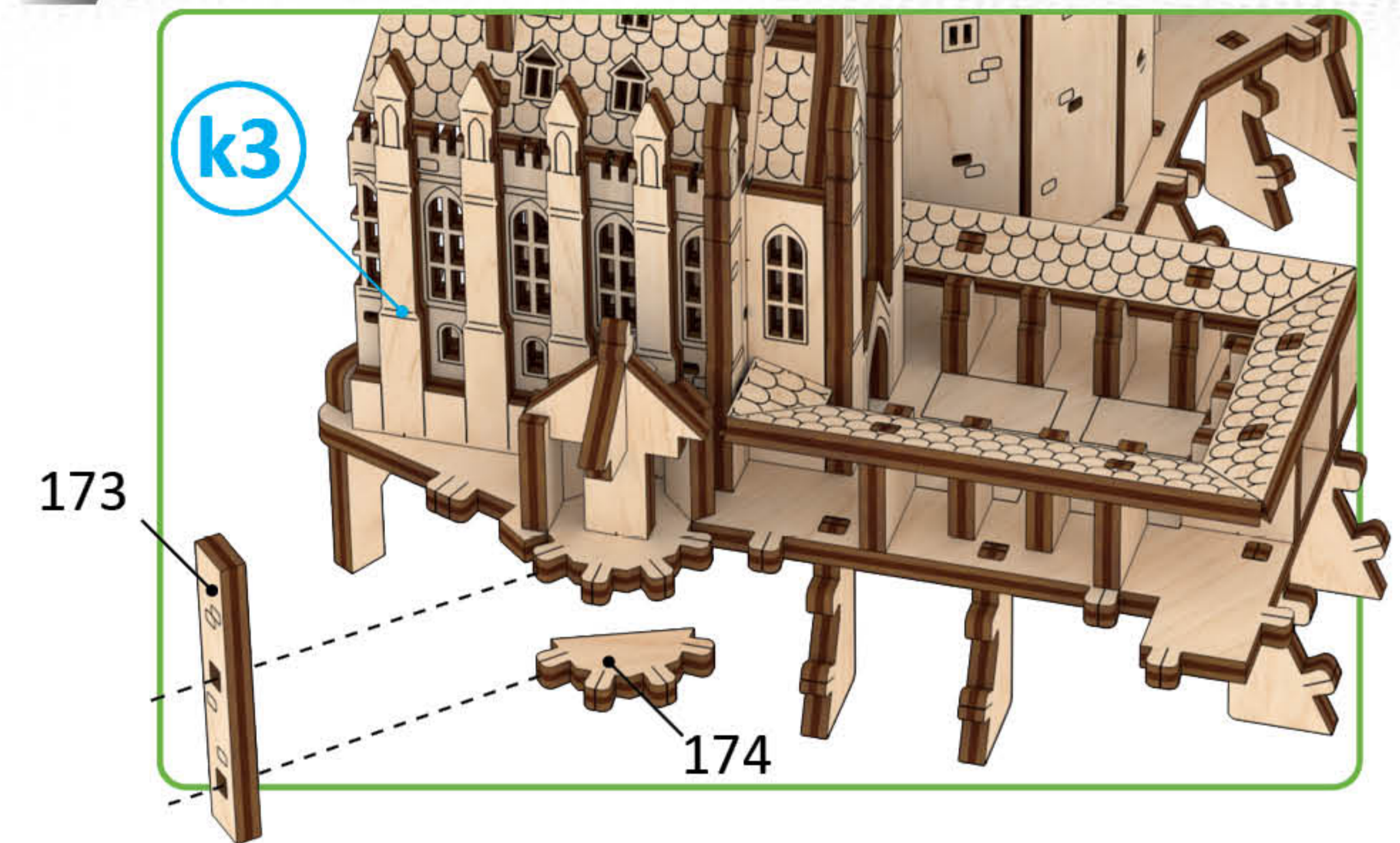

2

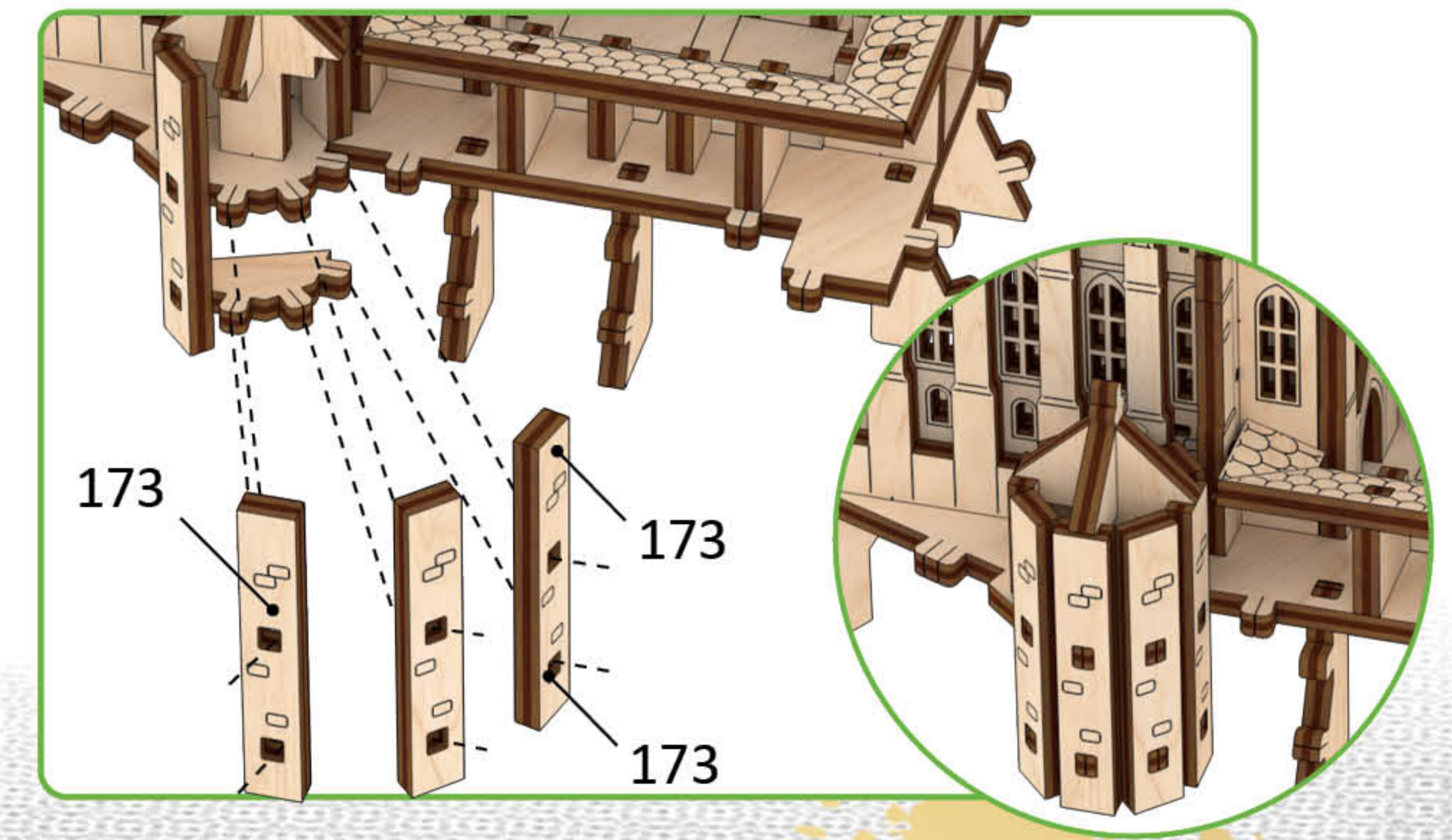

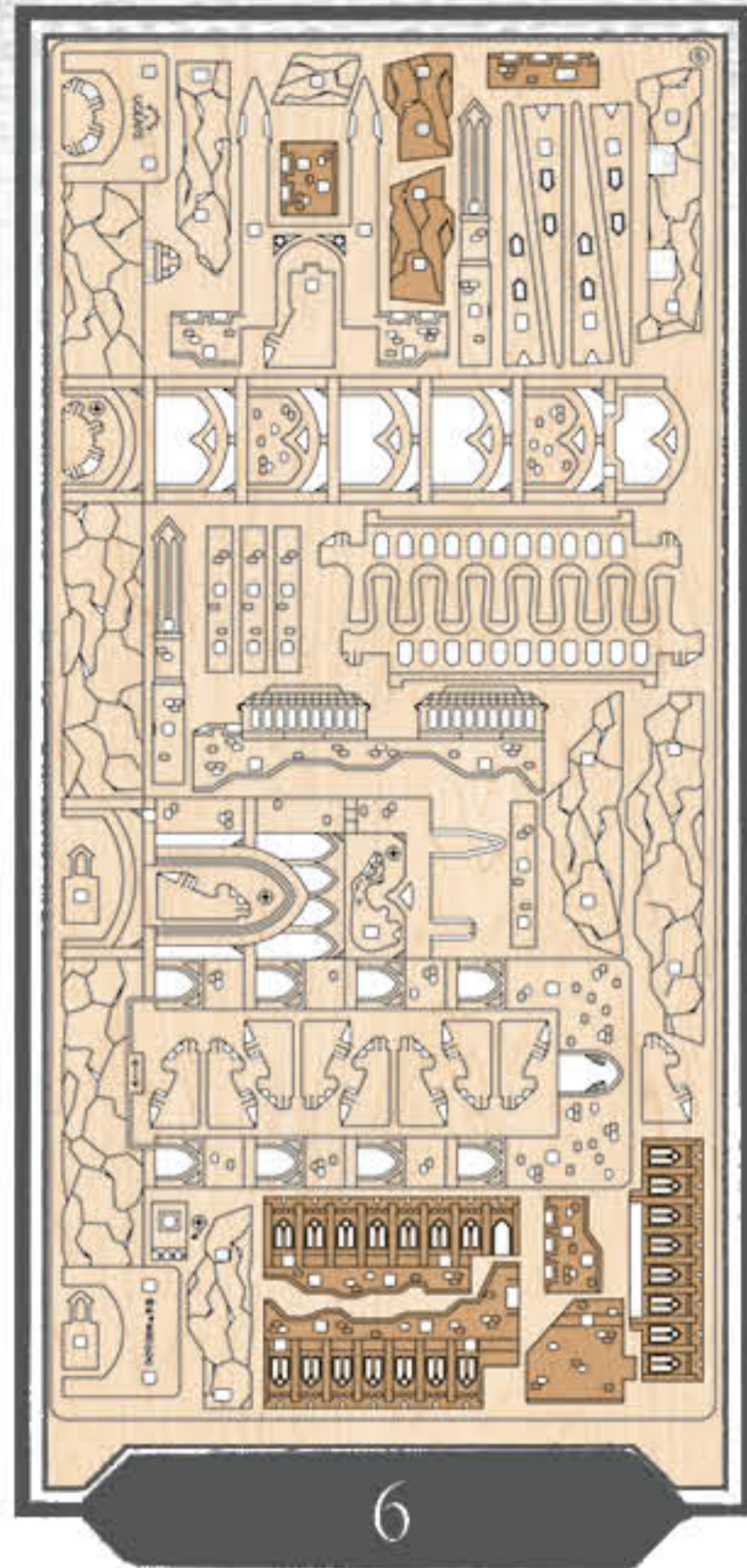

3

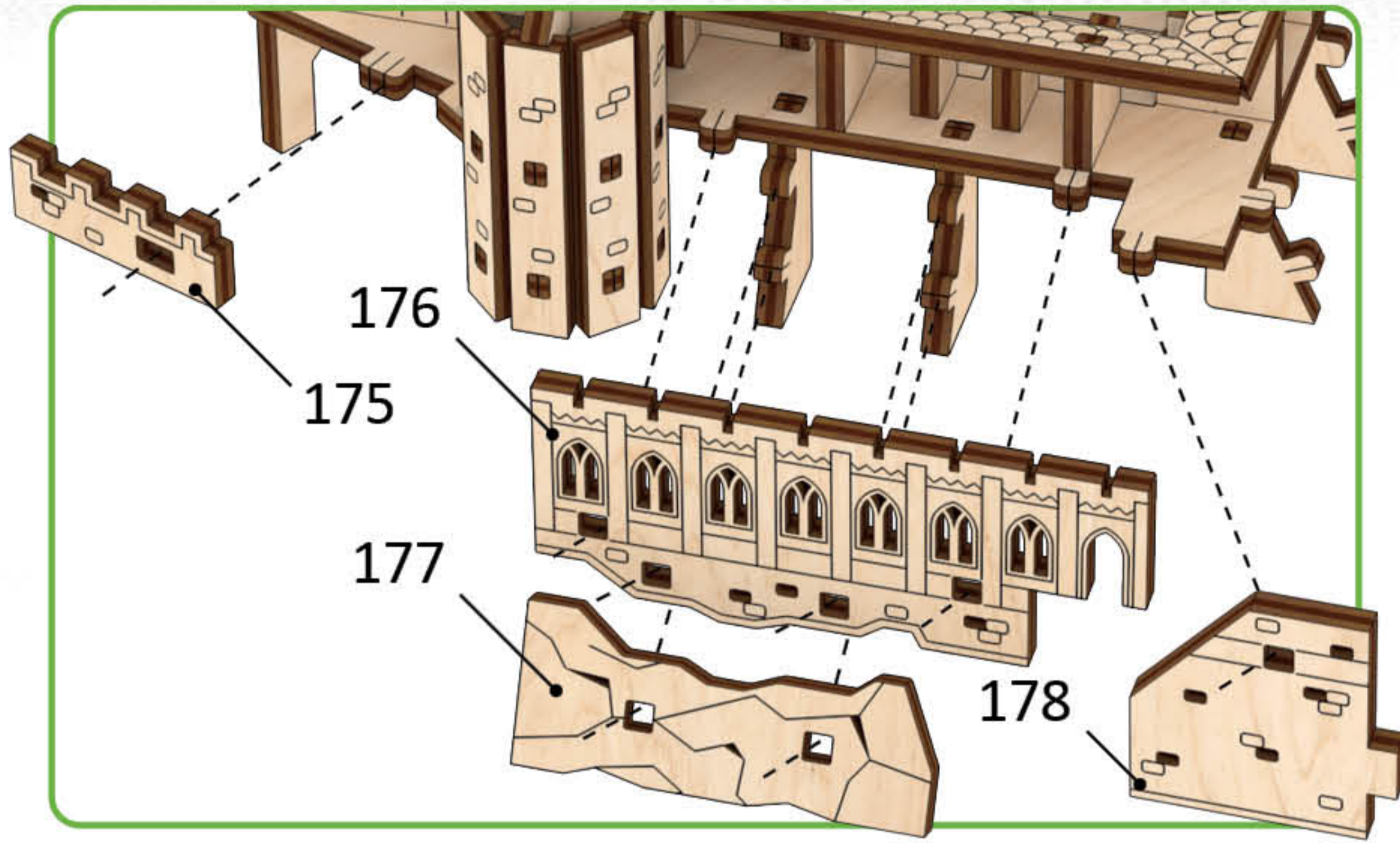

4

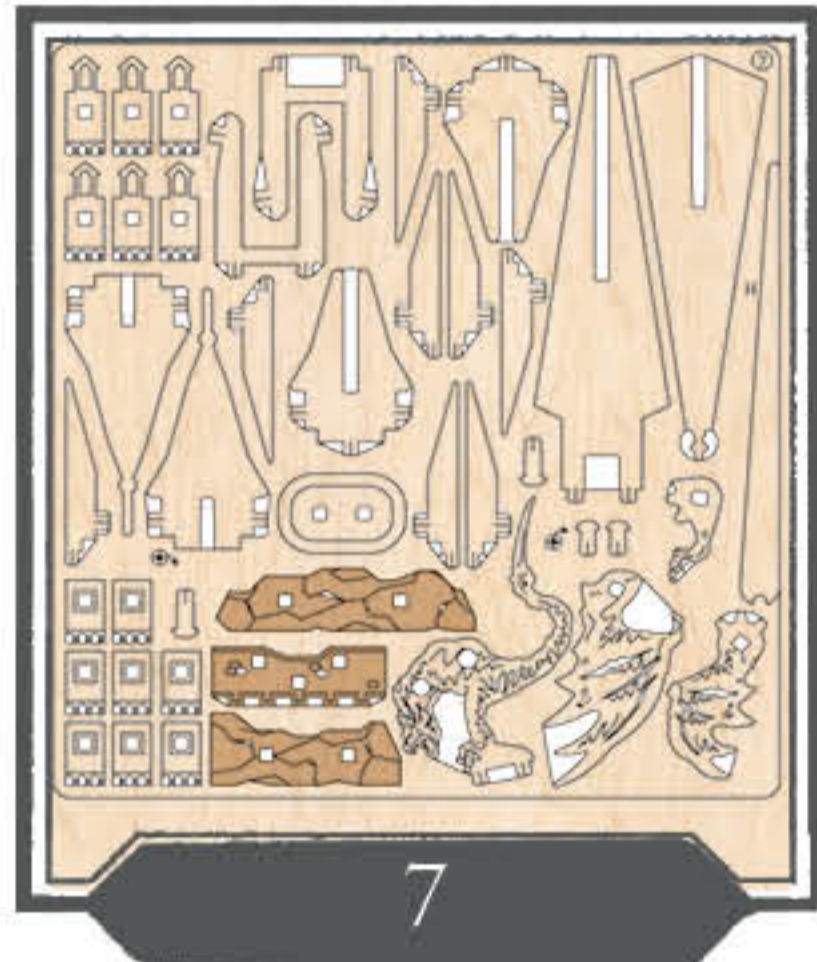
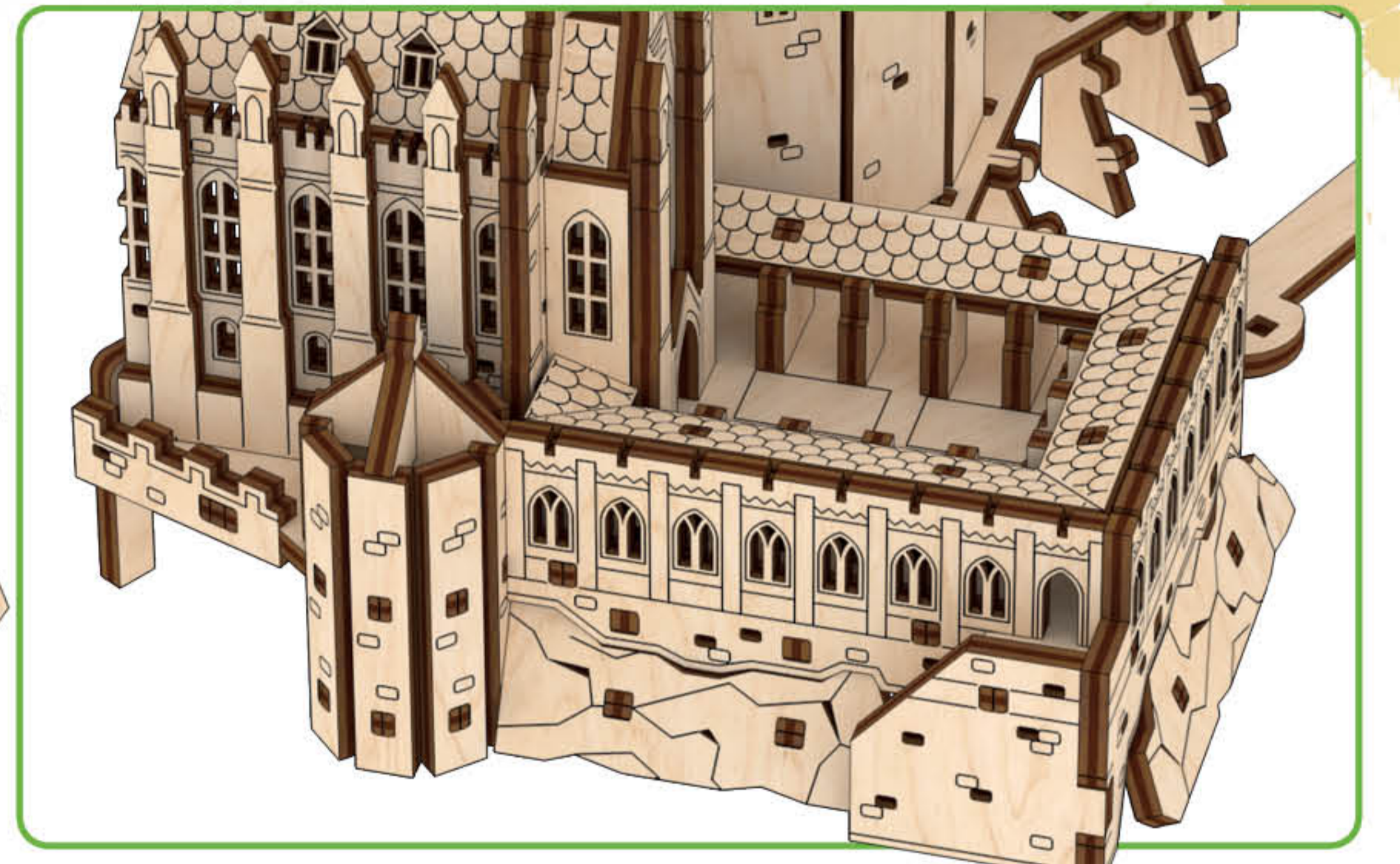
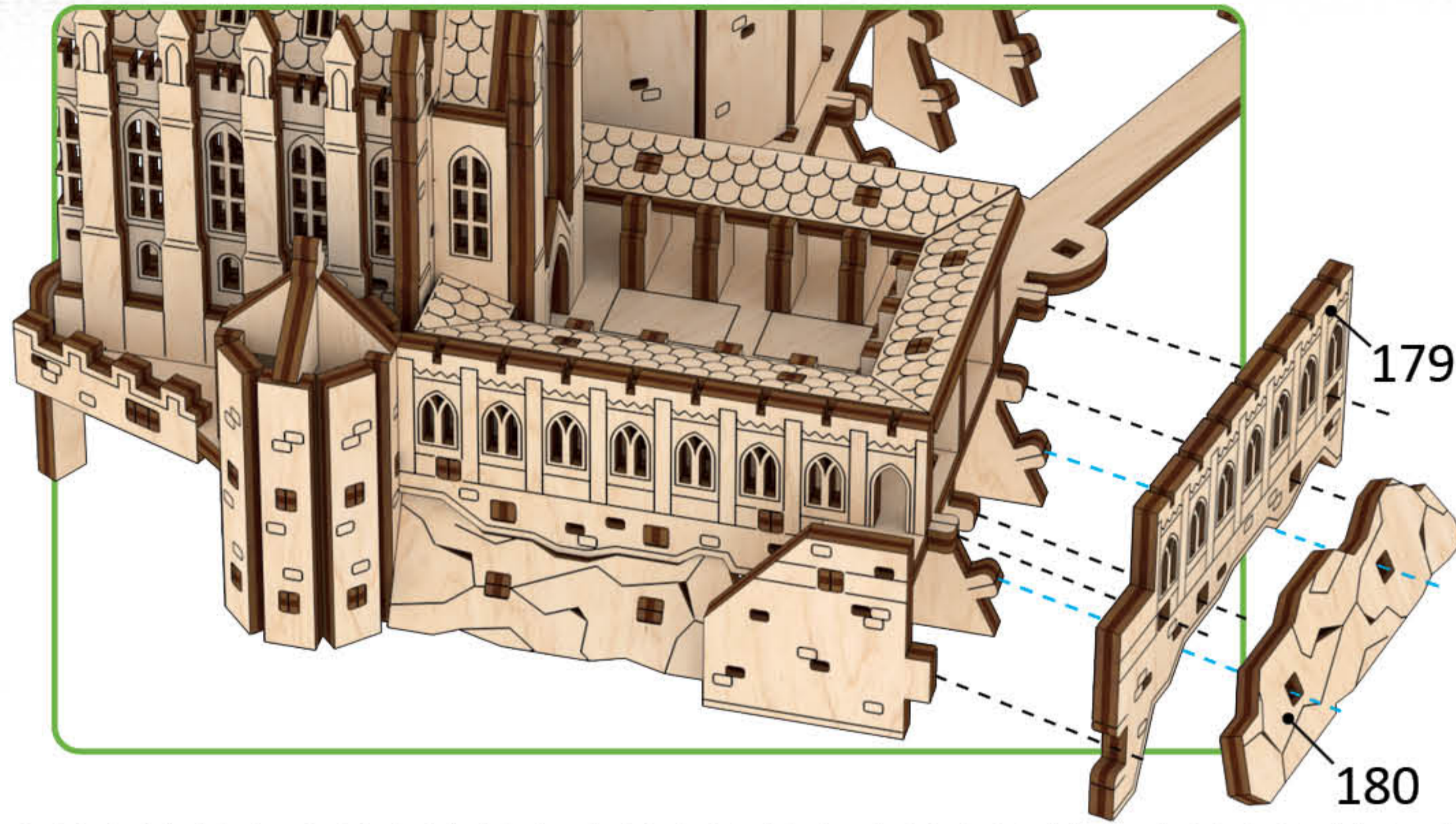

5

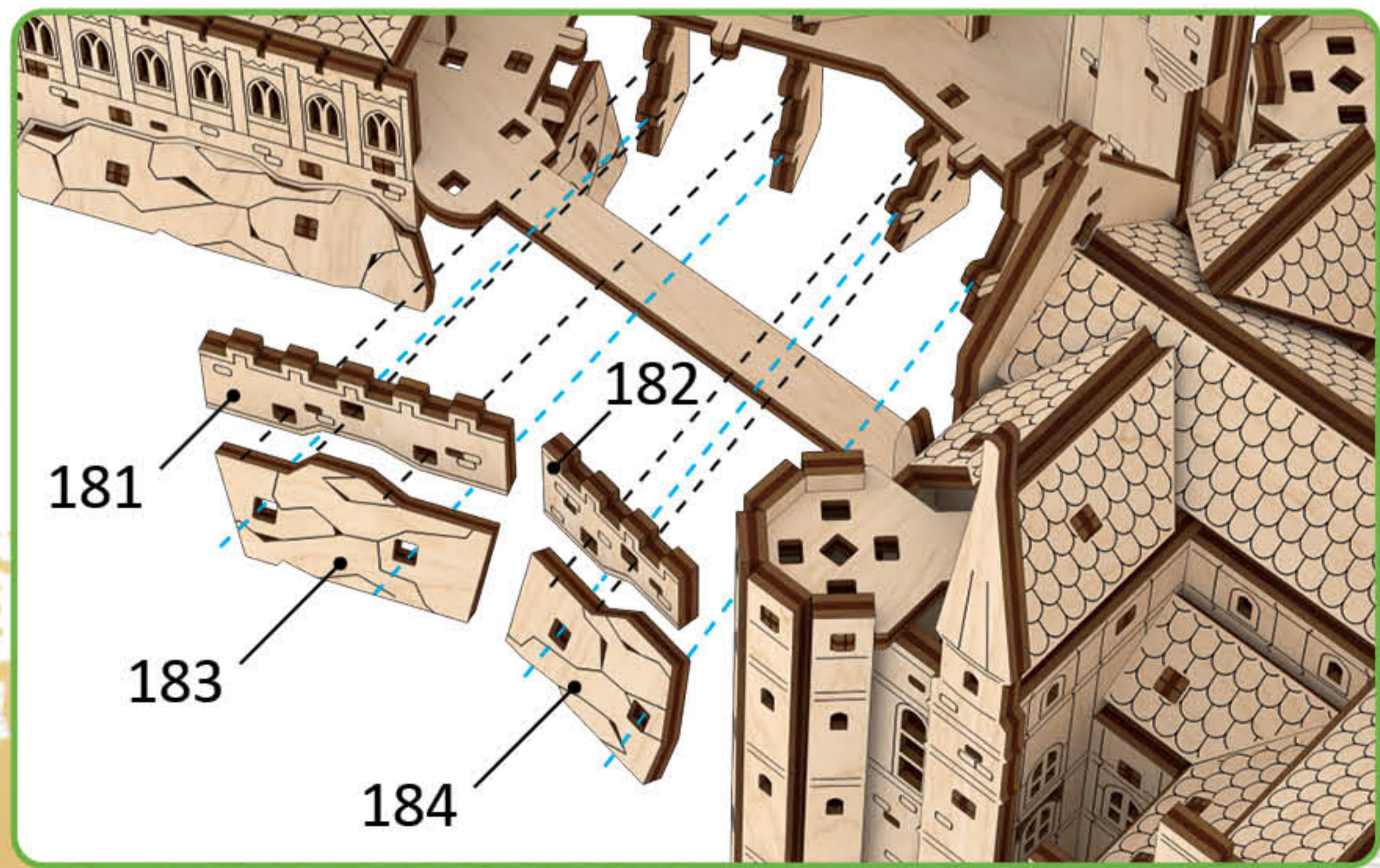

6

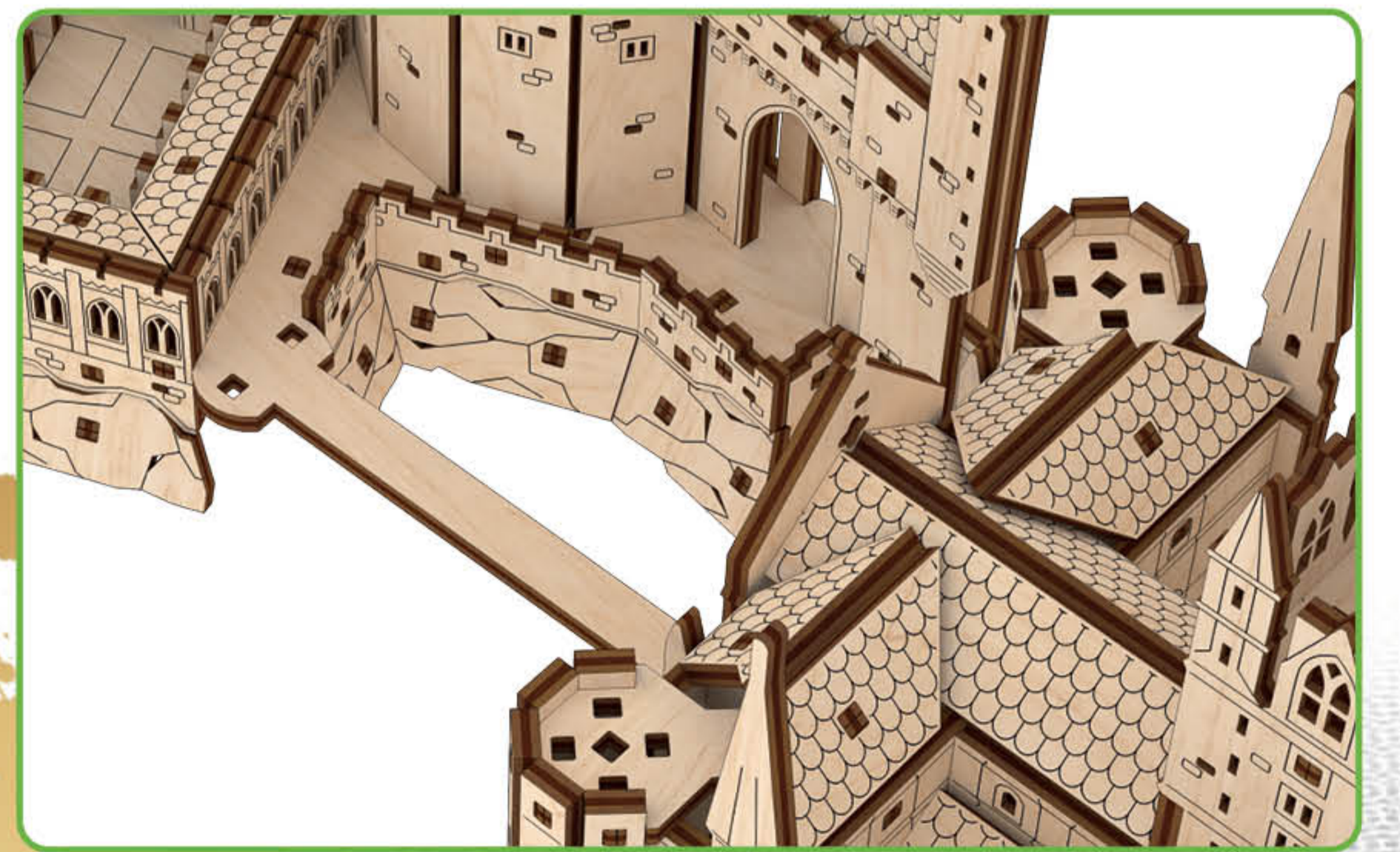
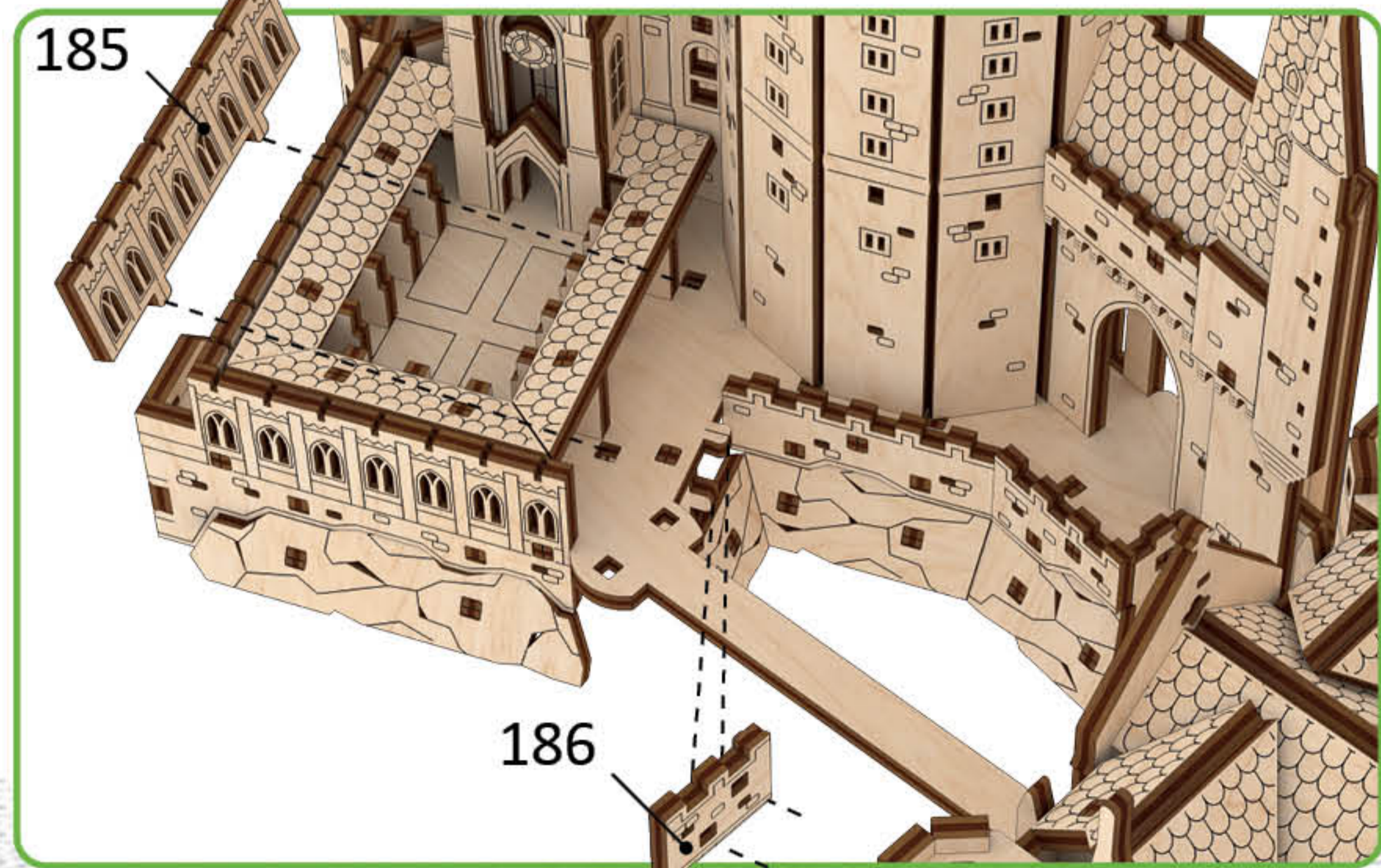

7

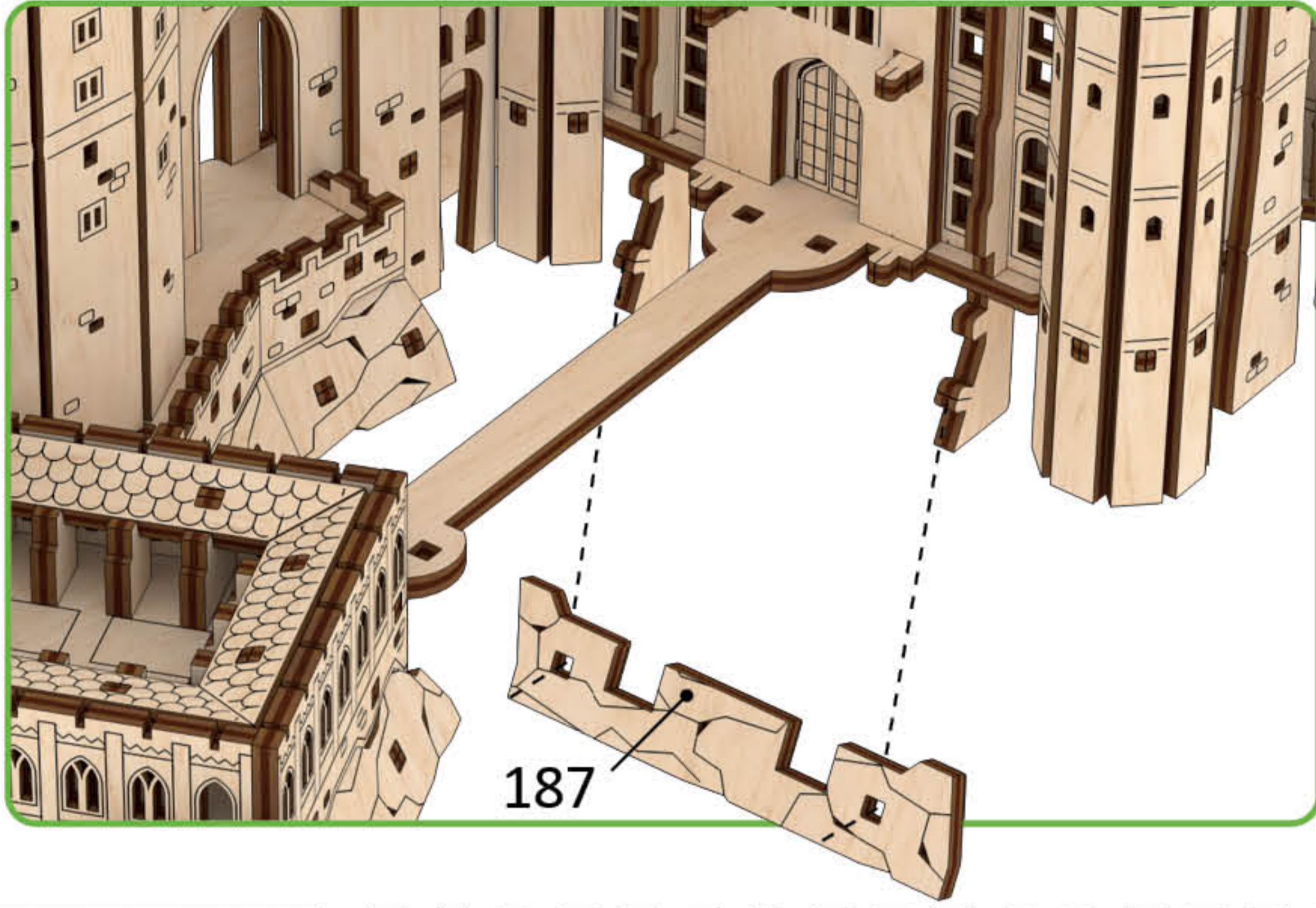

8

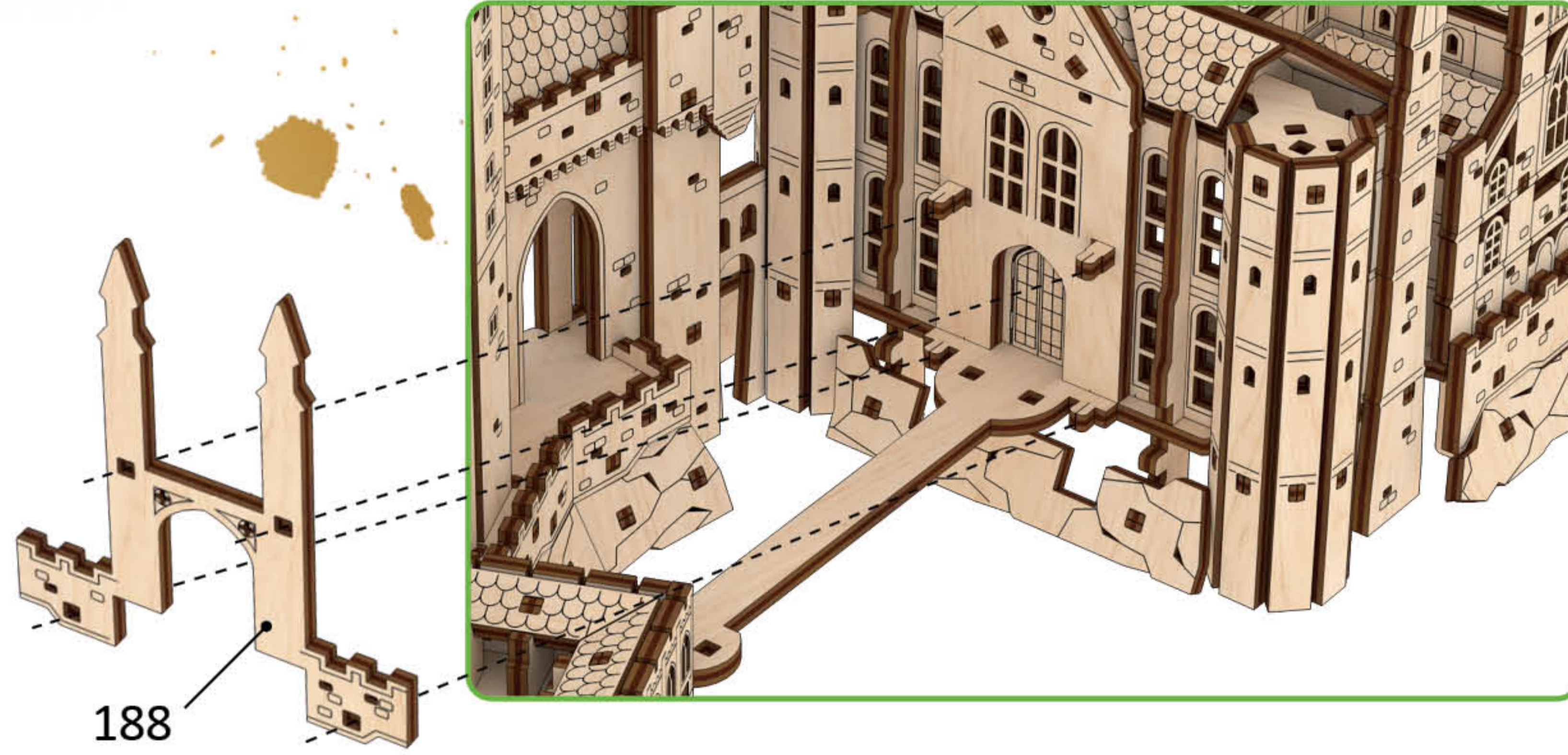

9

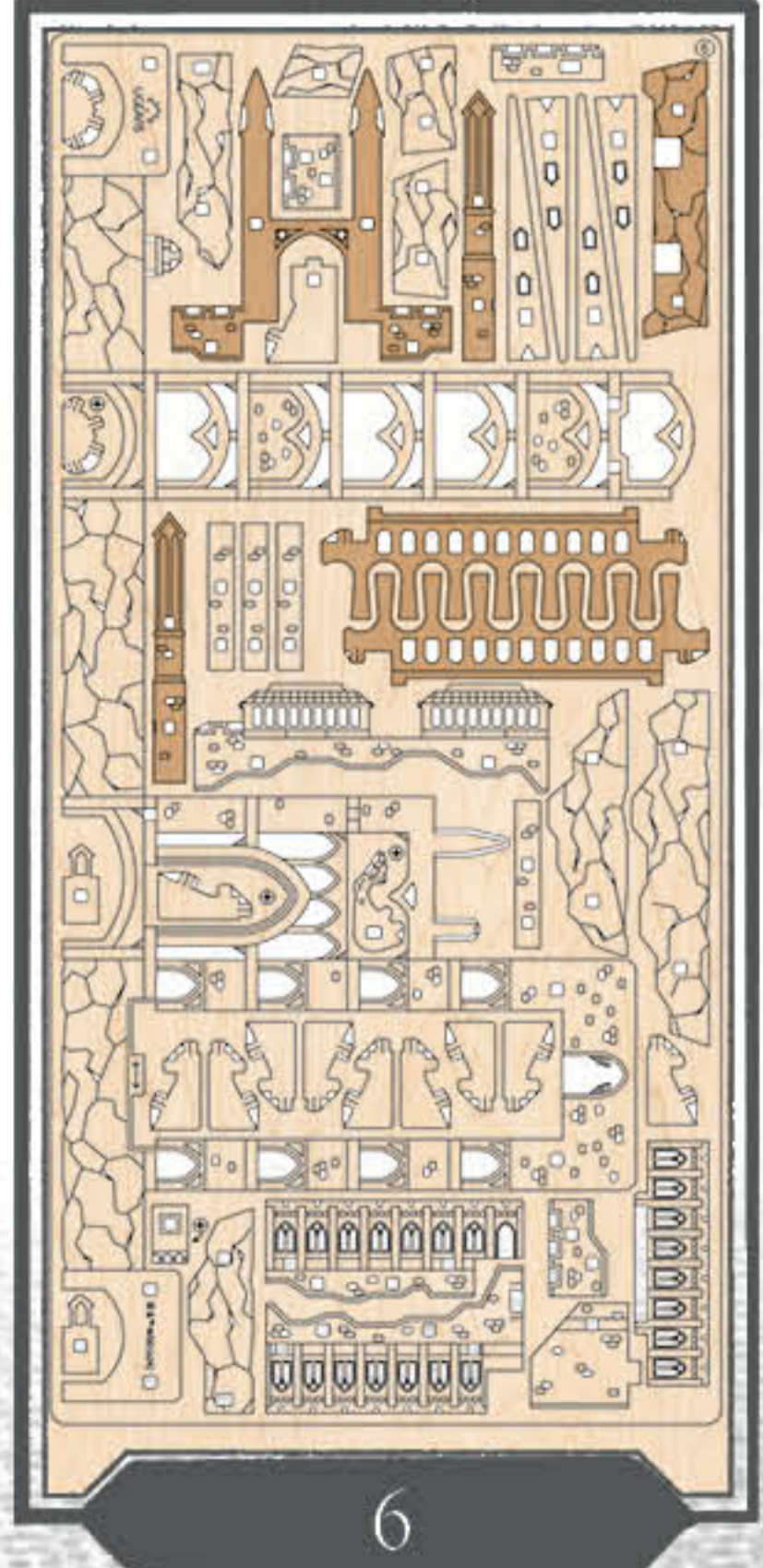

10

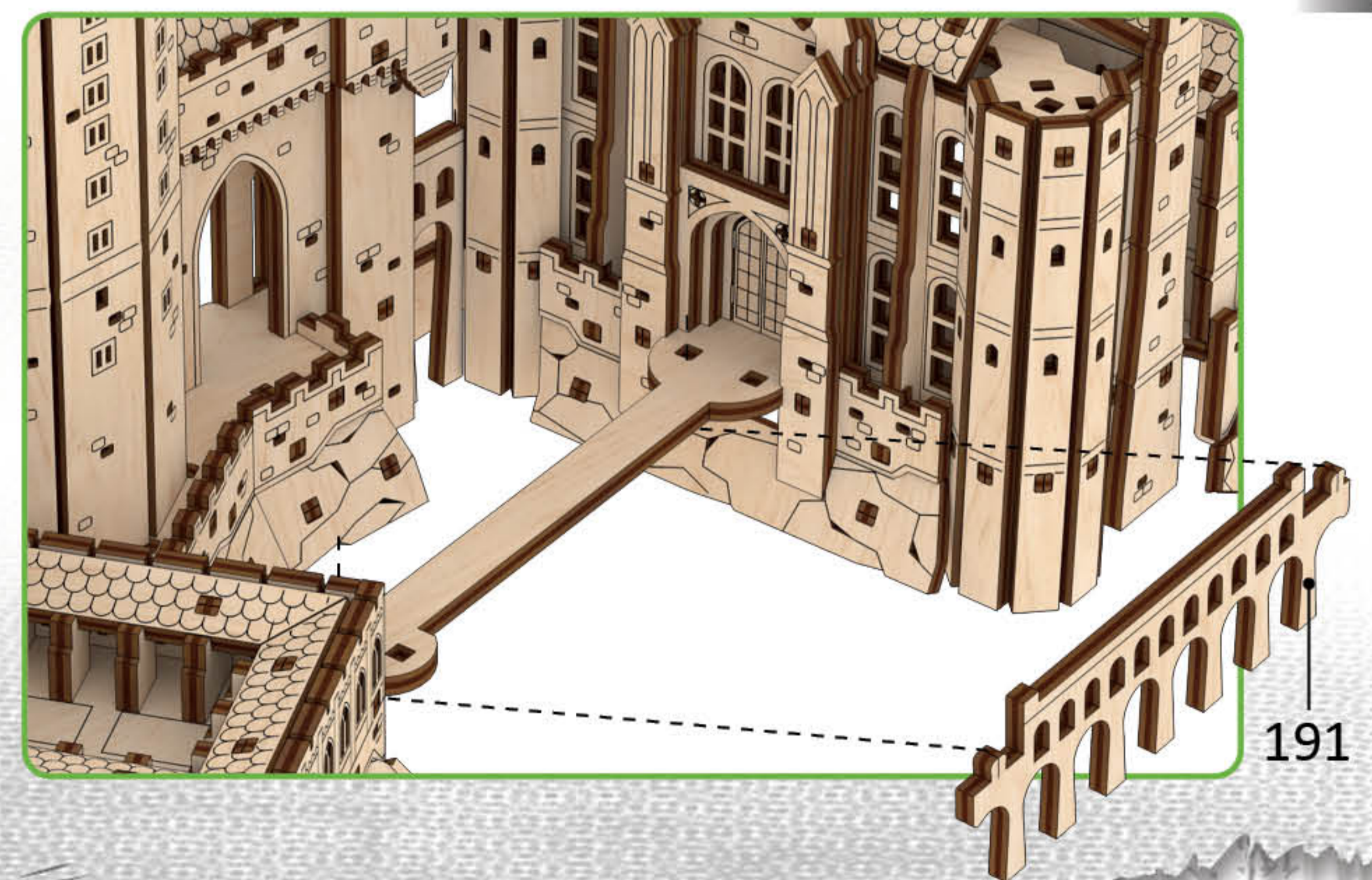

11

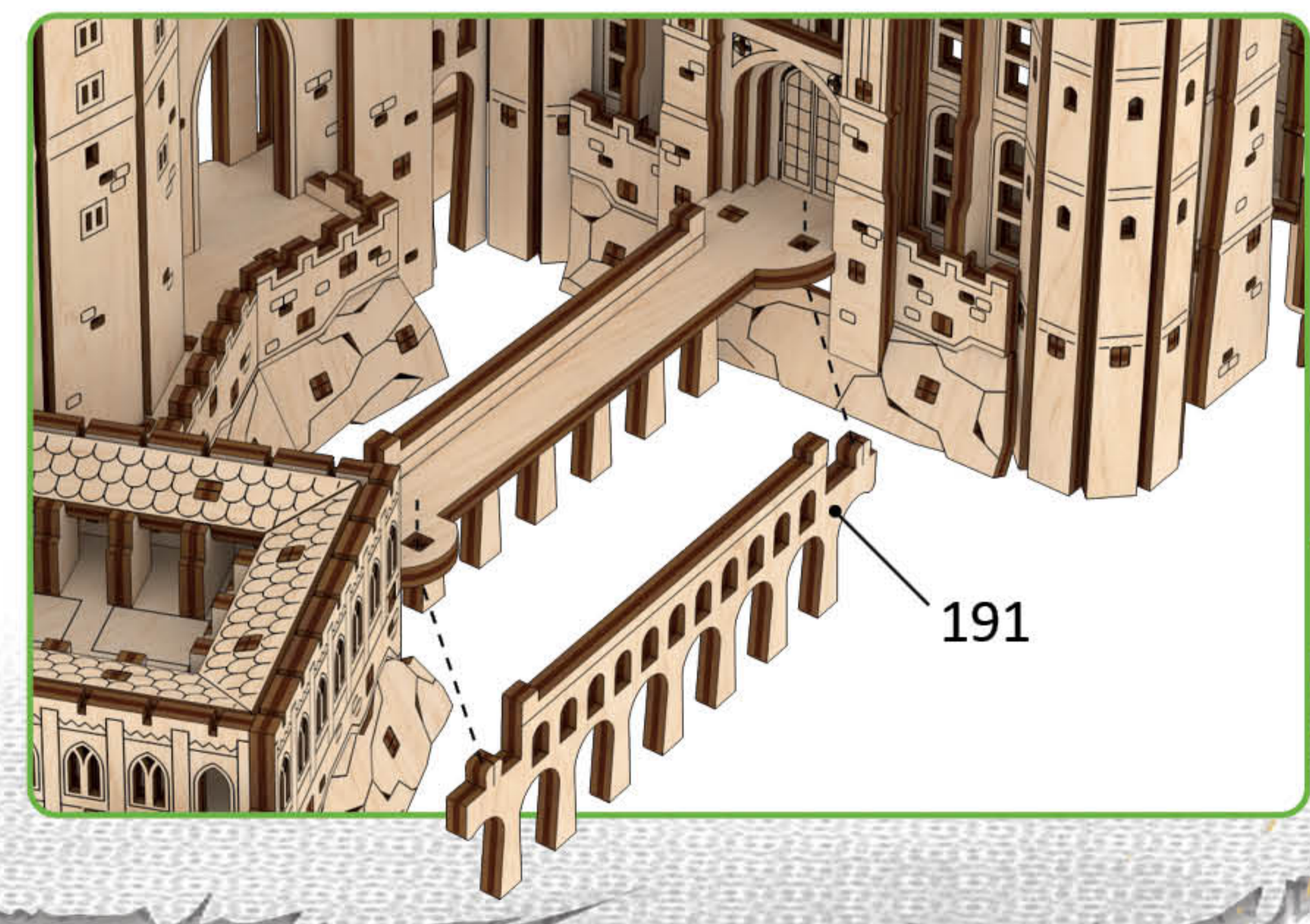

K

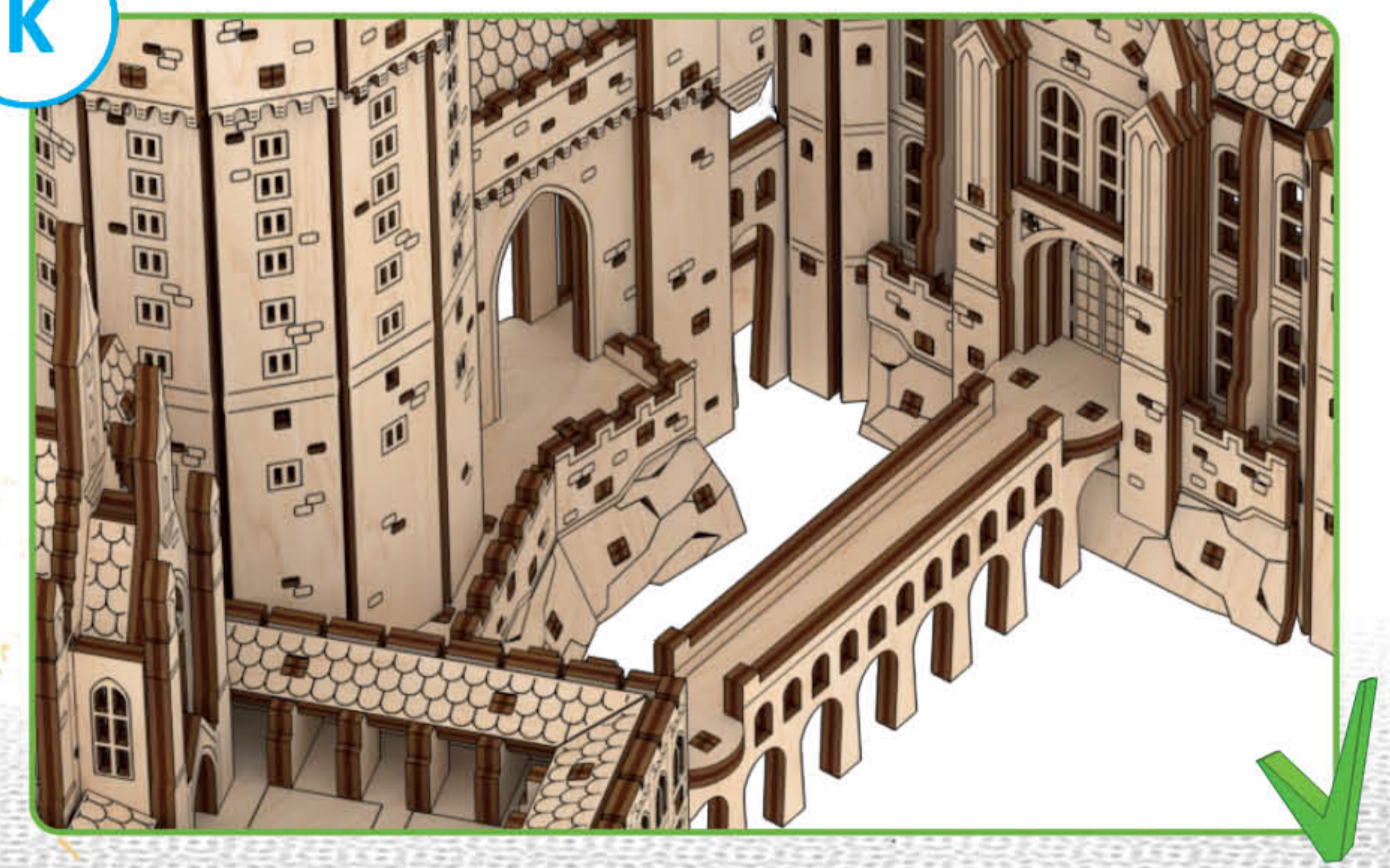

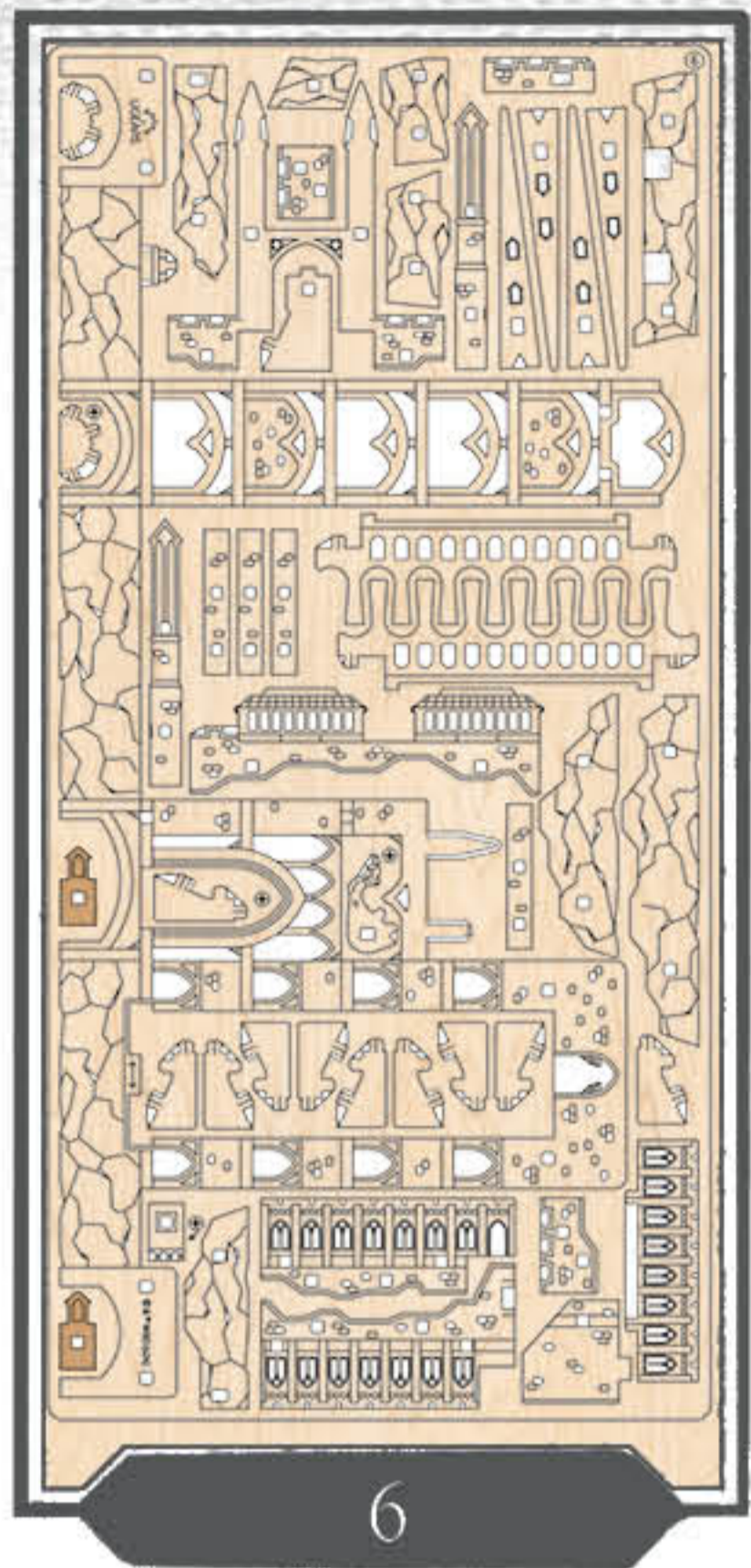

1

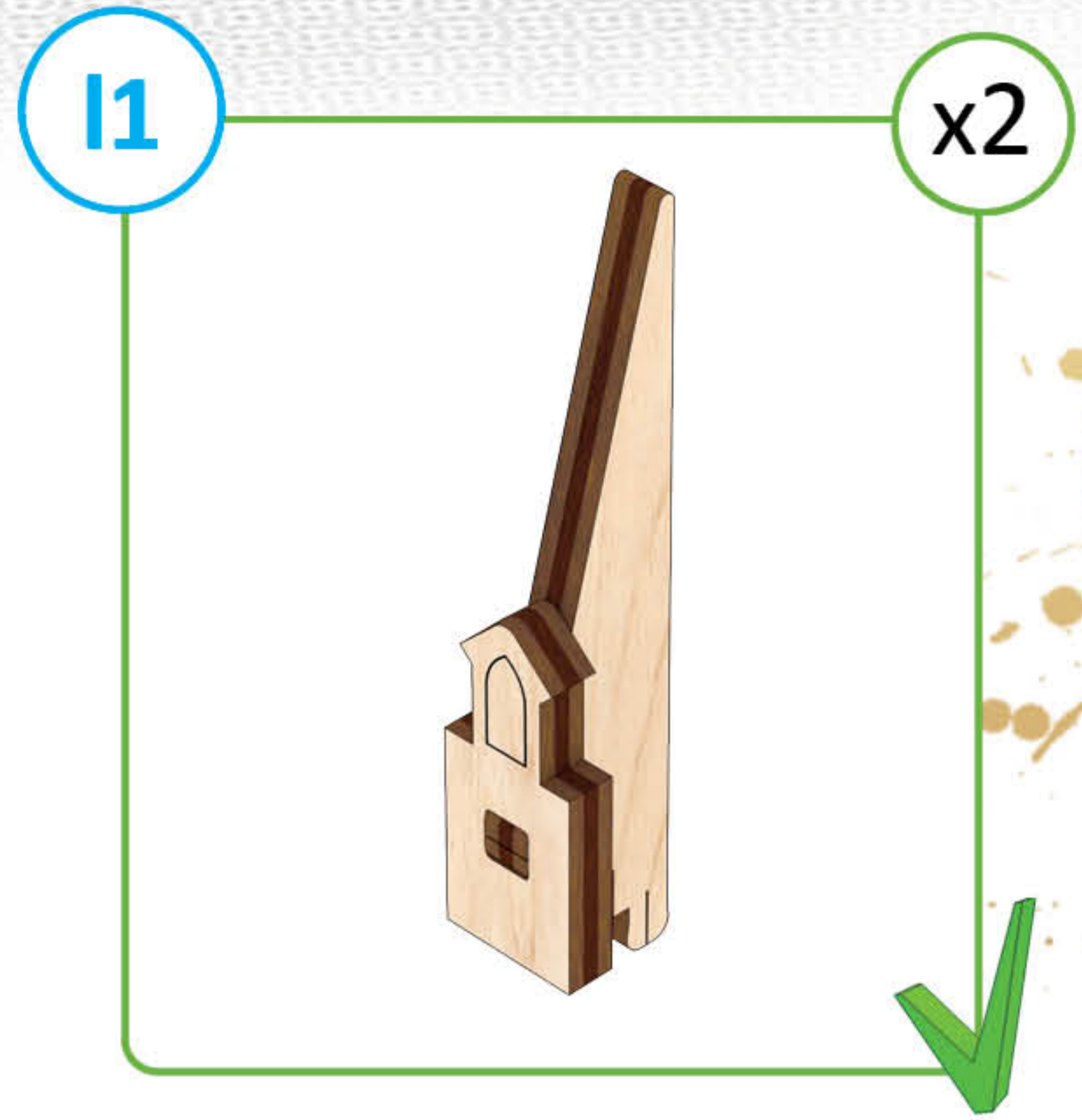
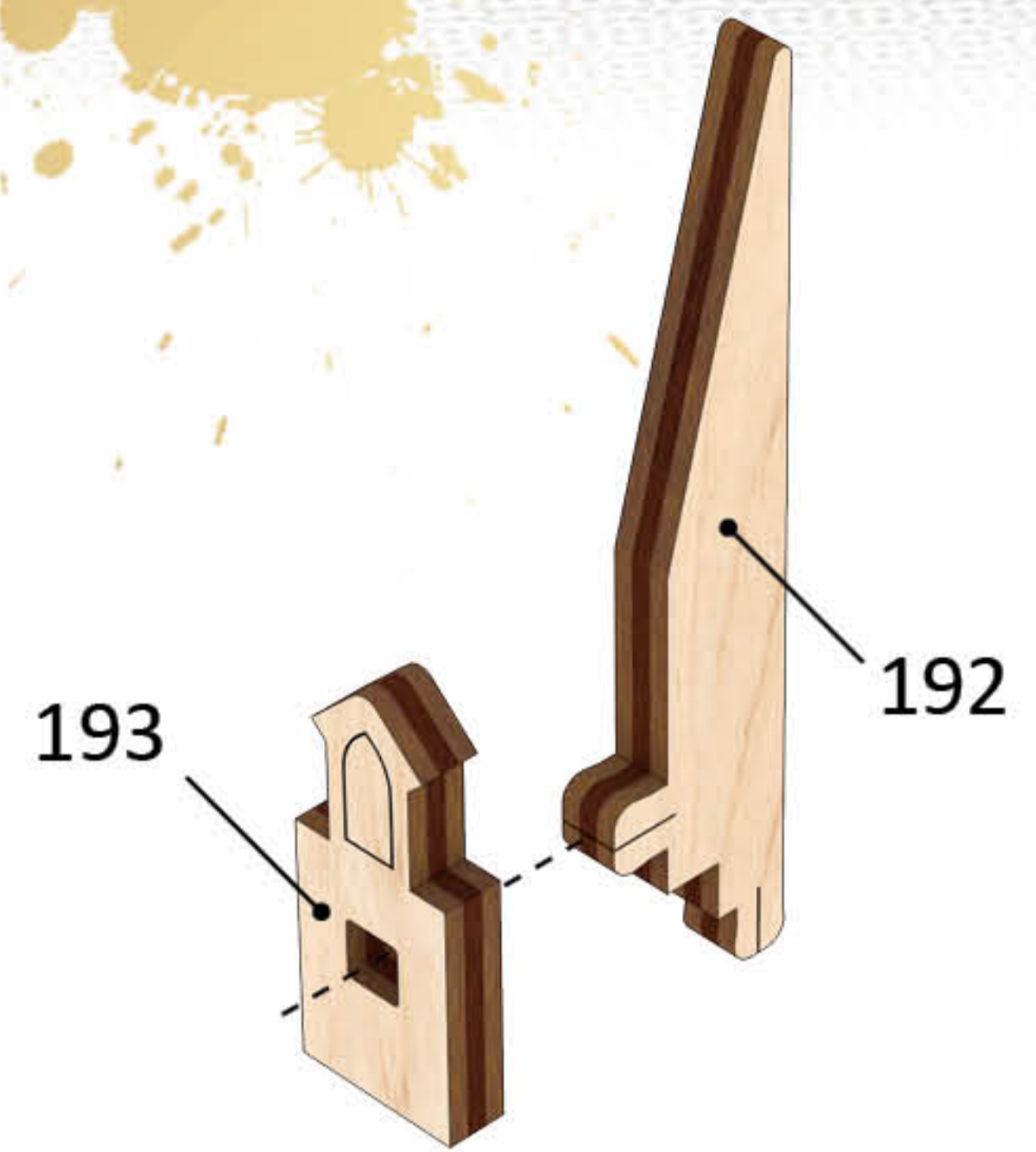

1

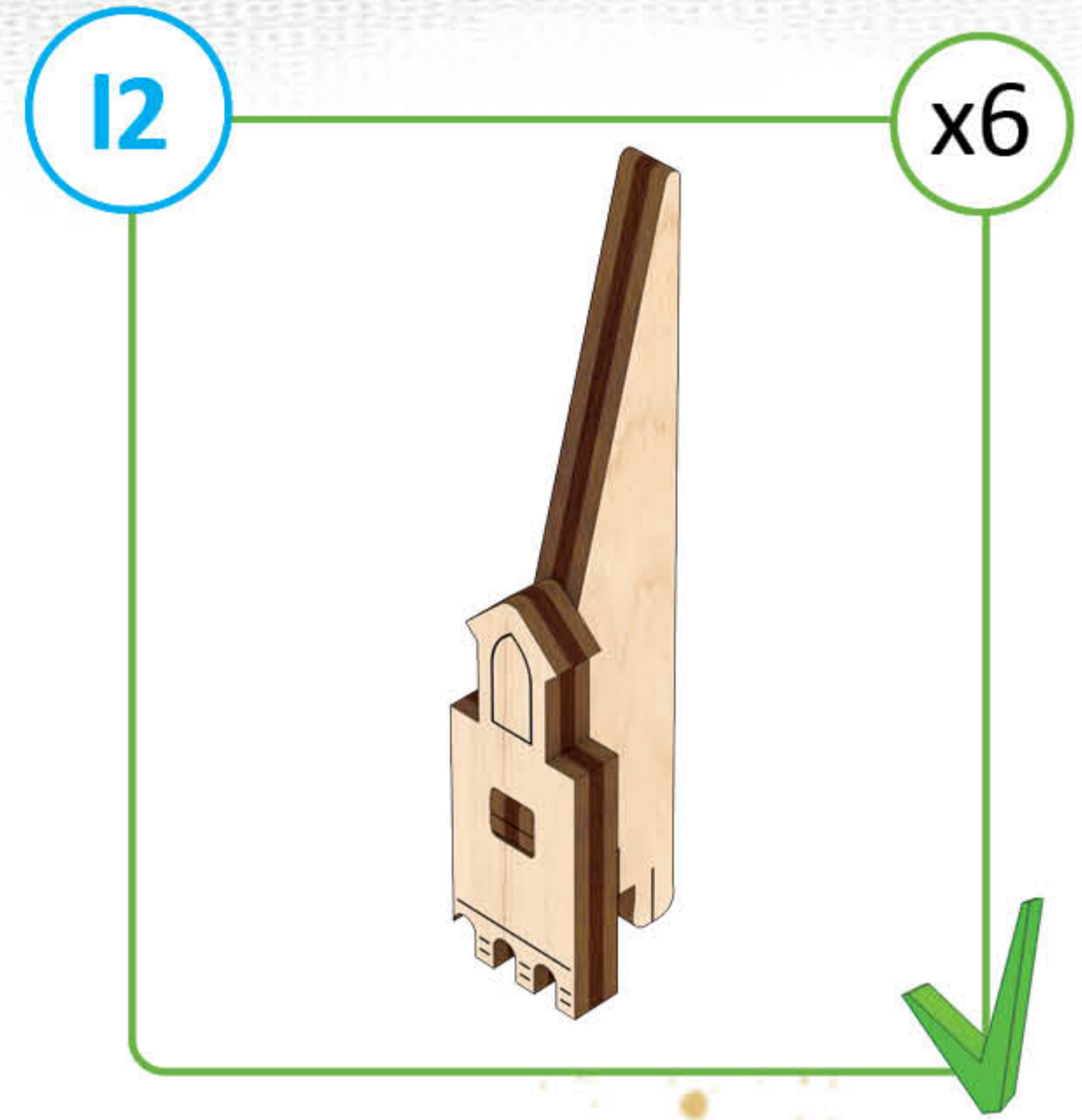
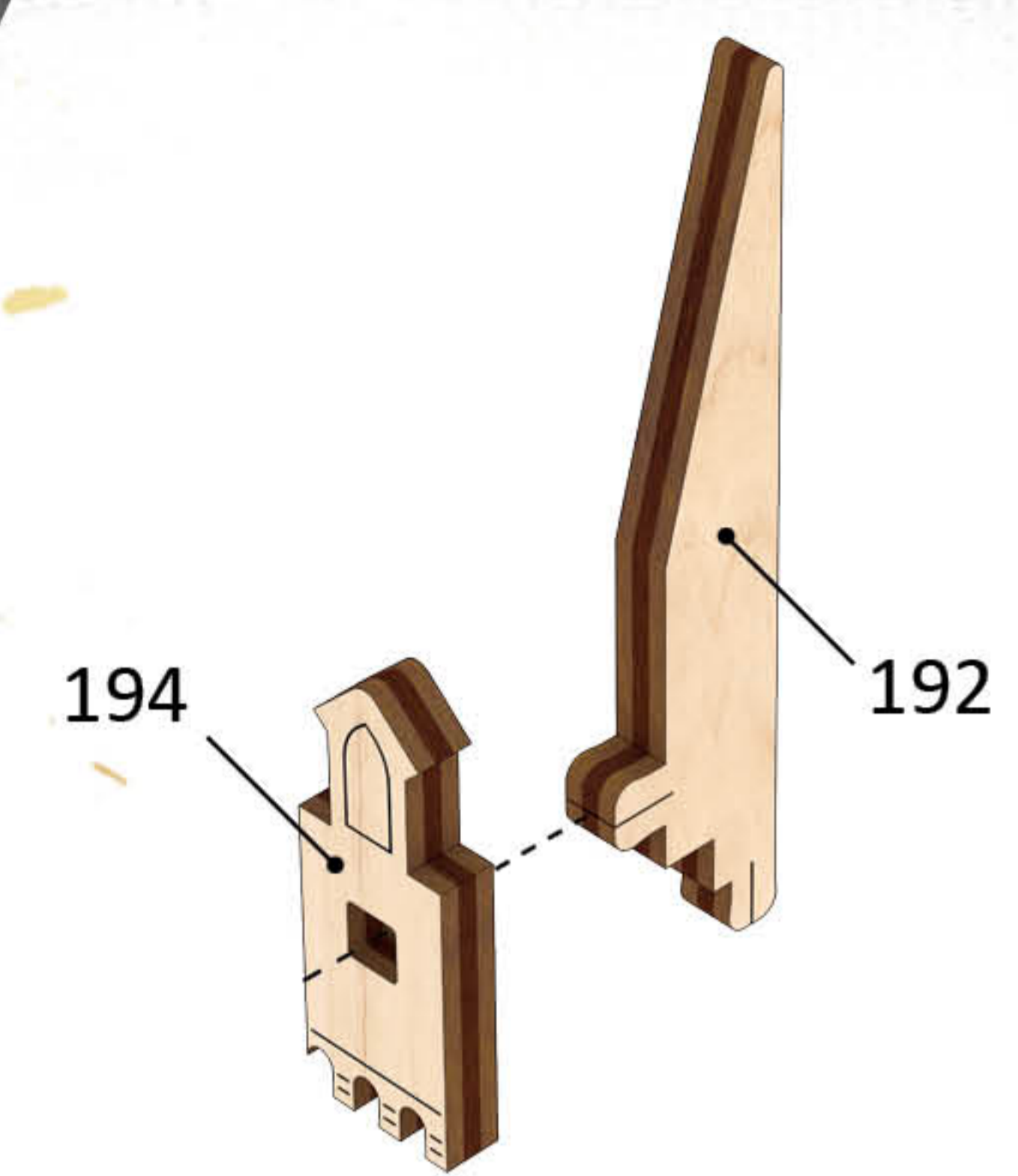

1

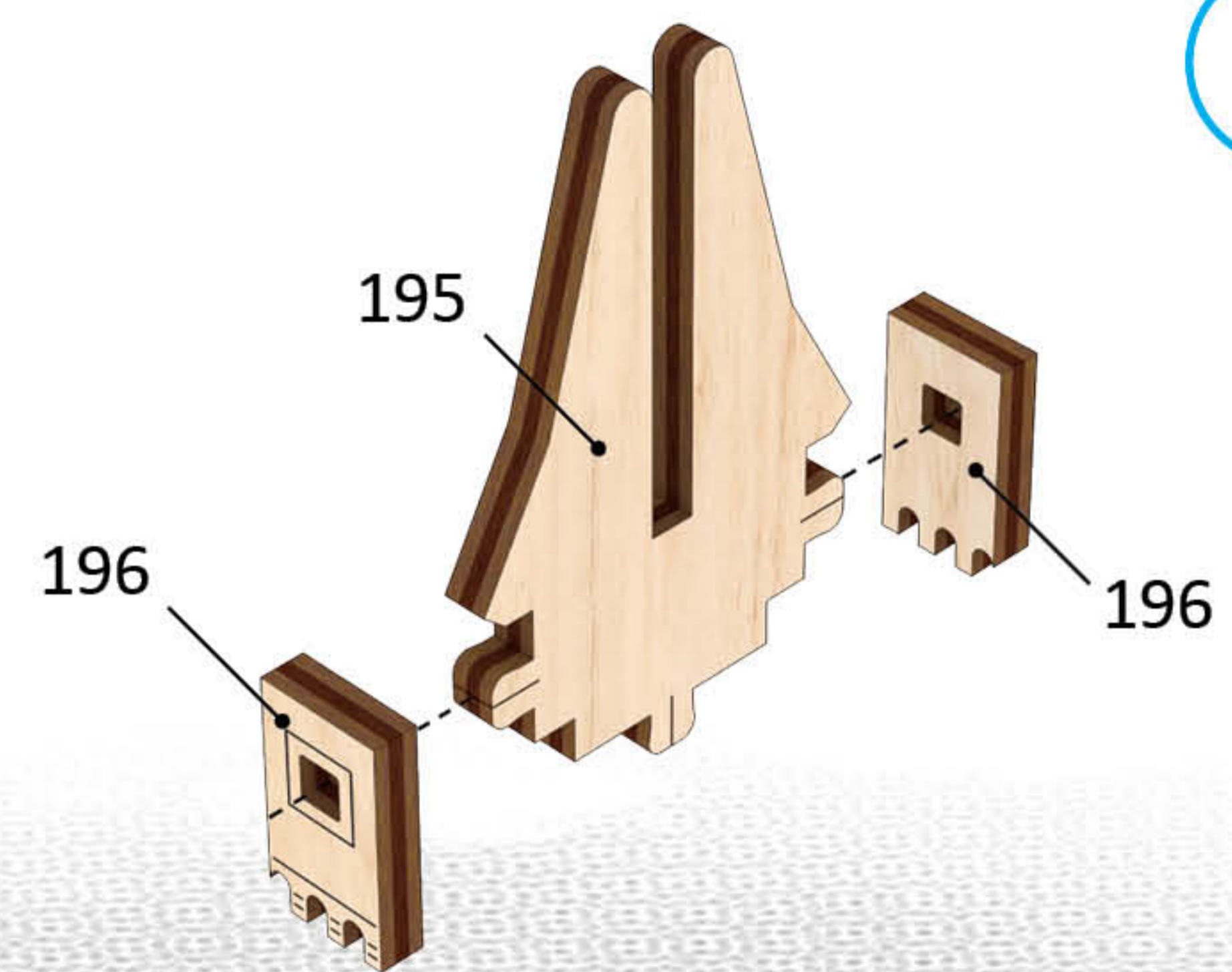

1

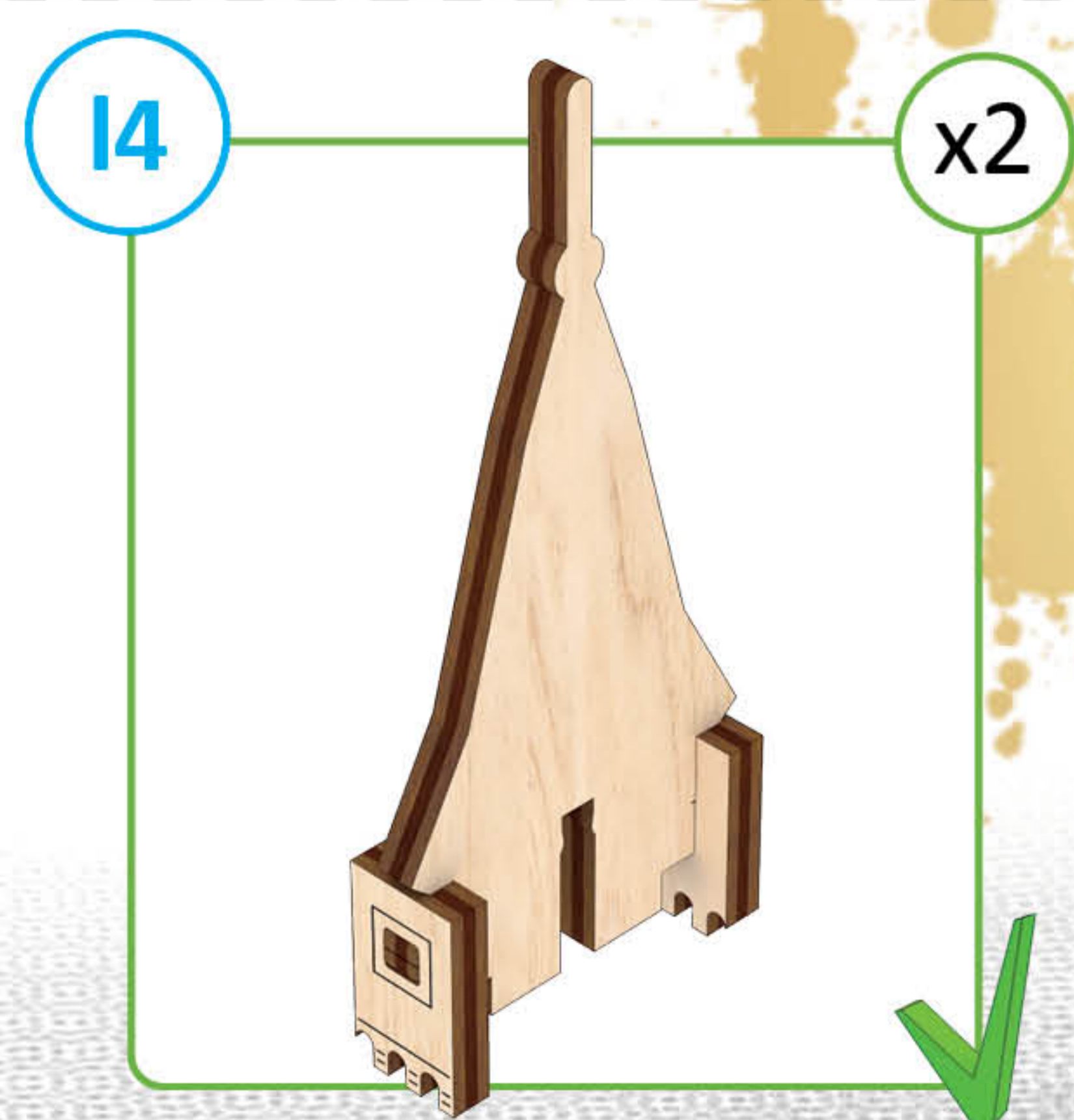
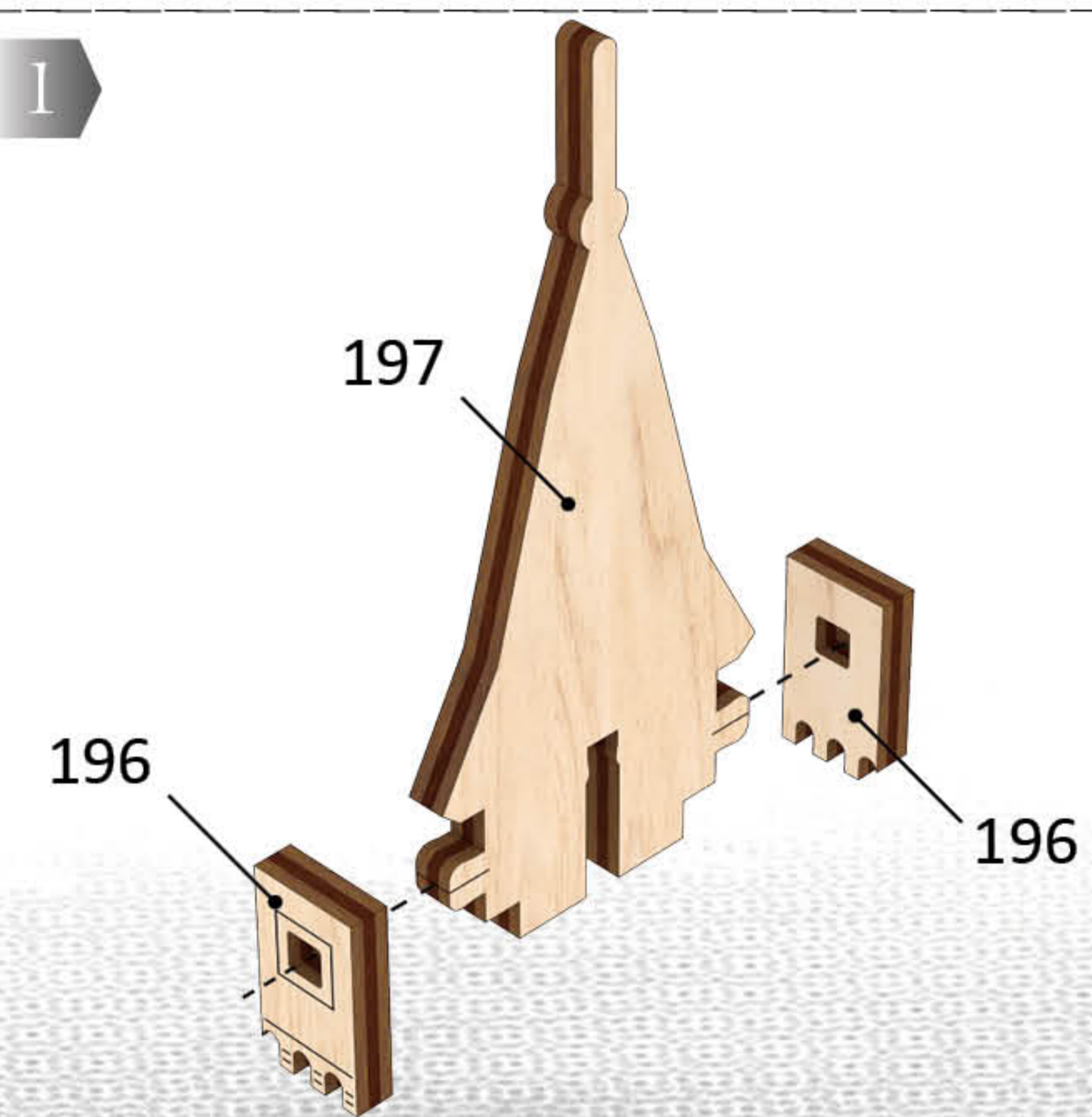

1

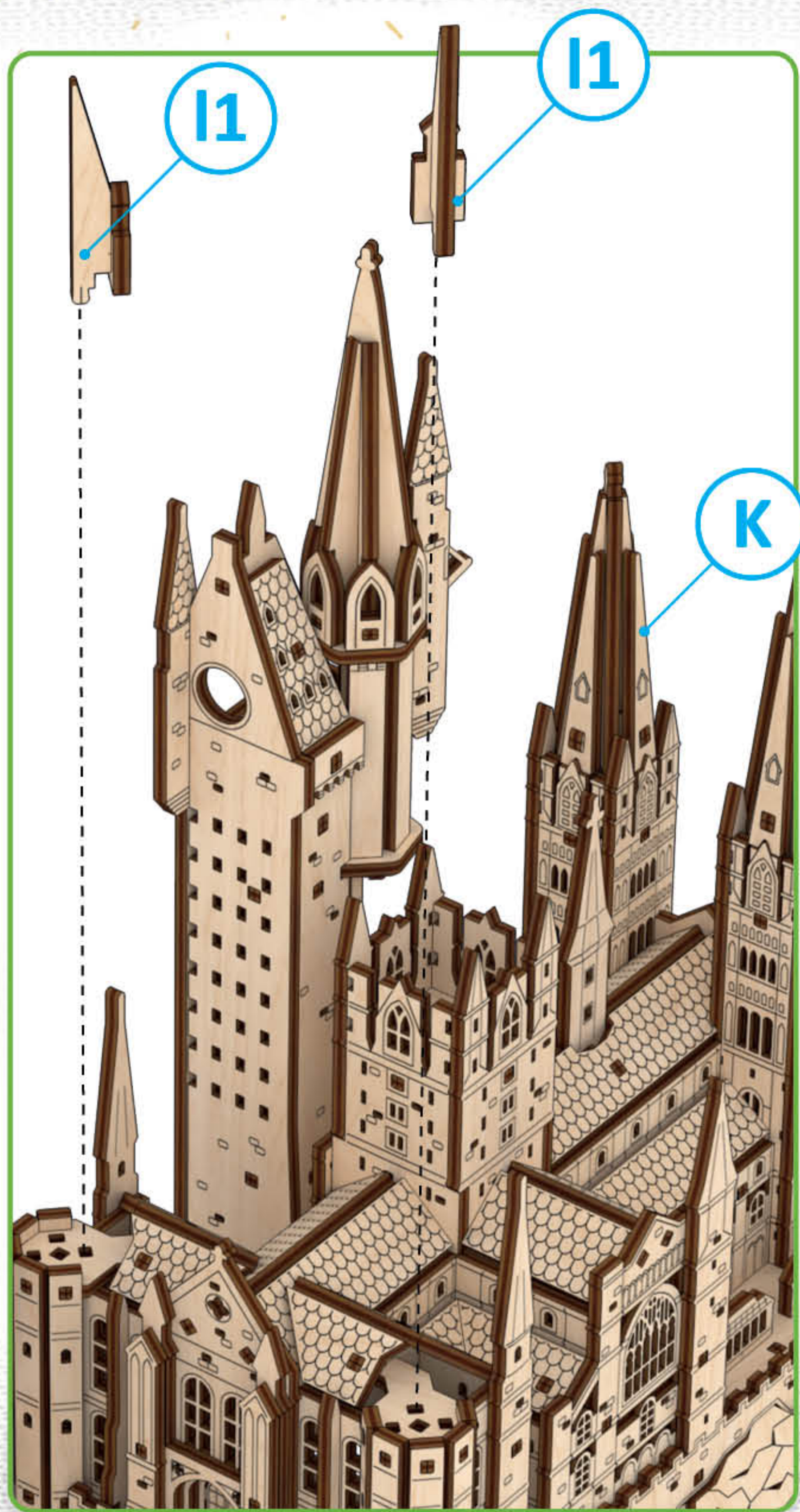

2

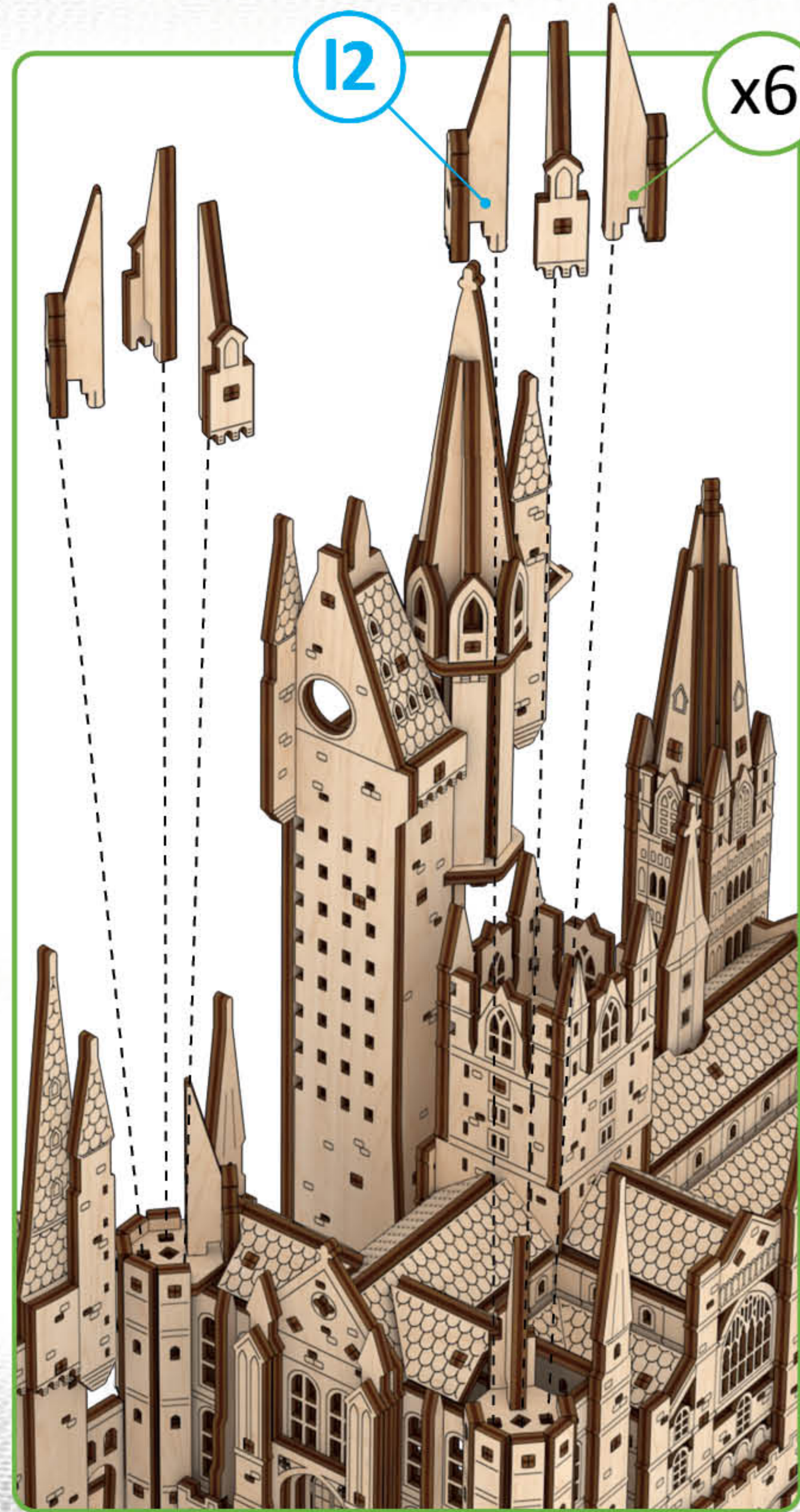

3

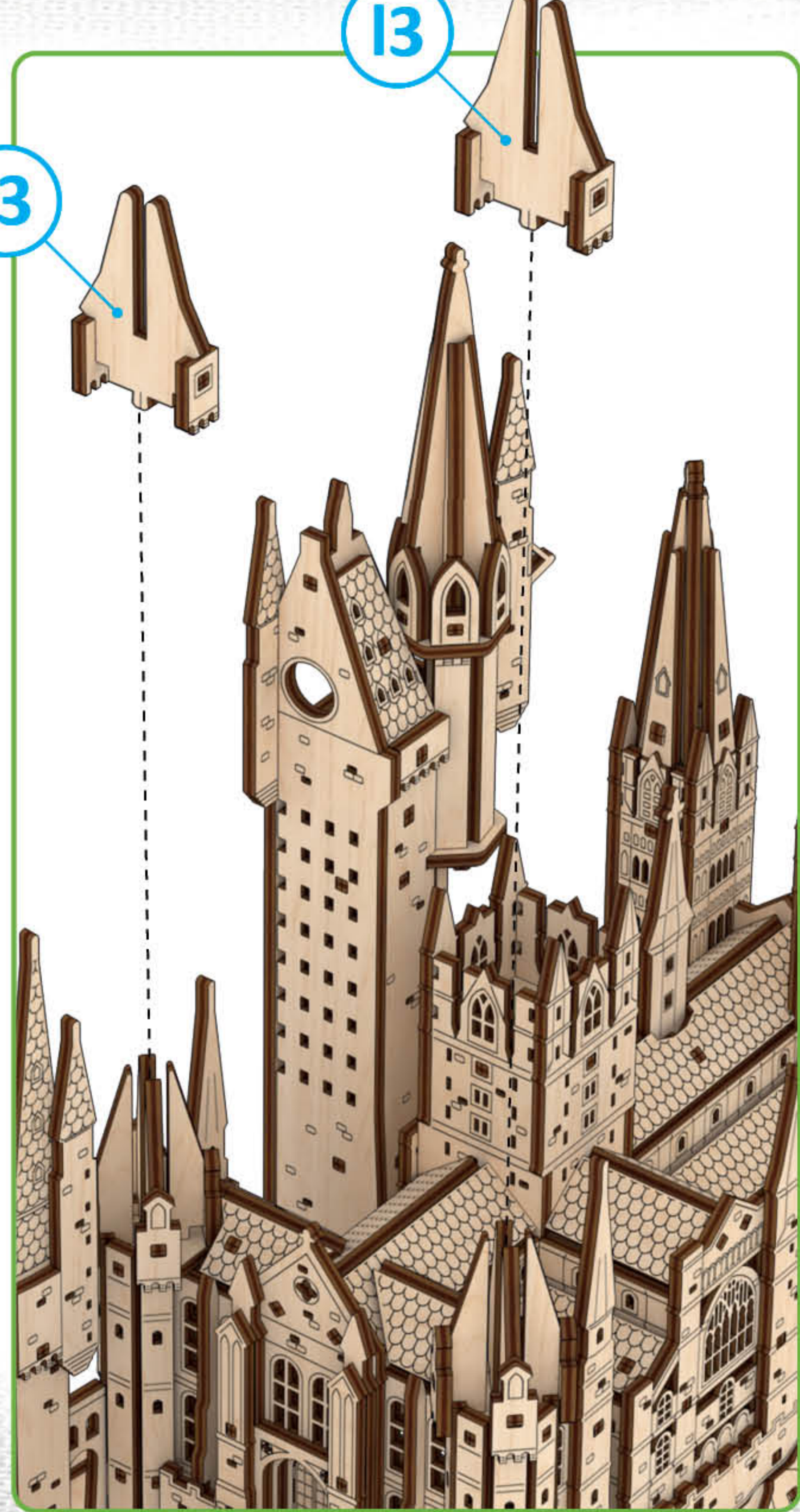

4

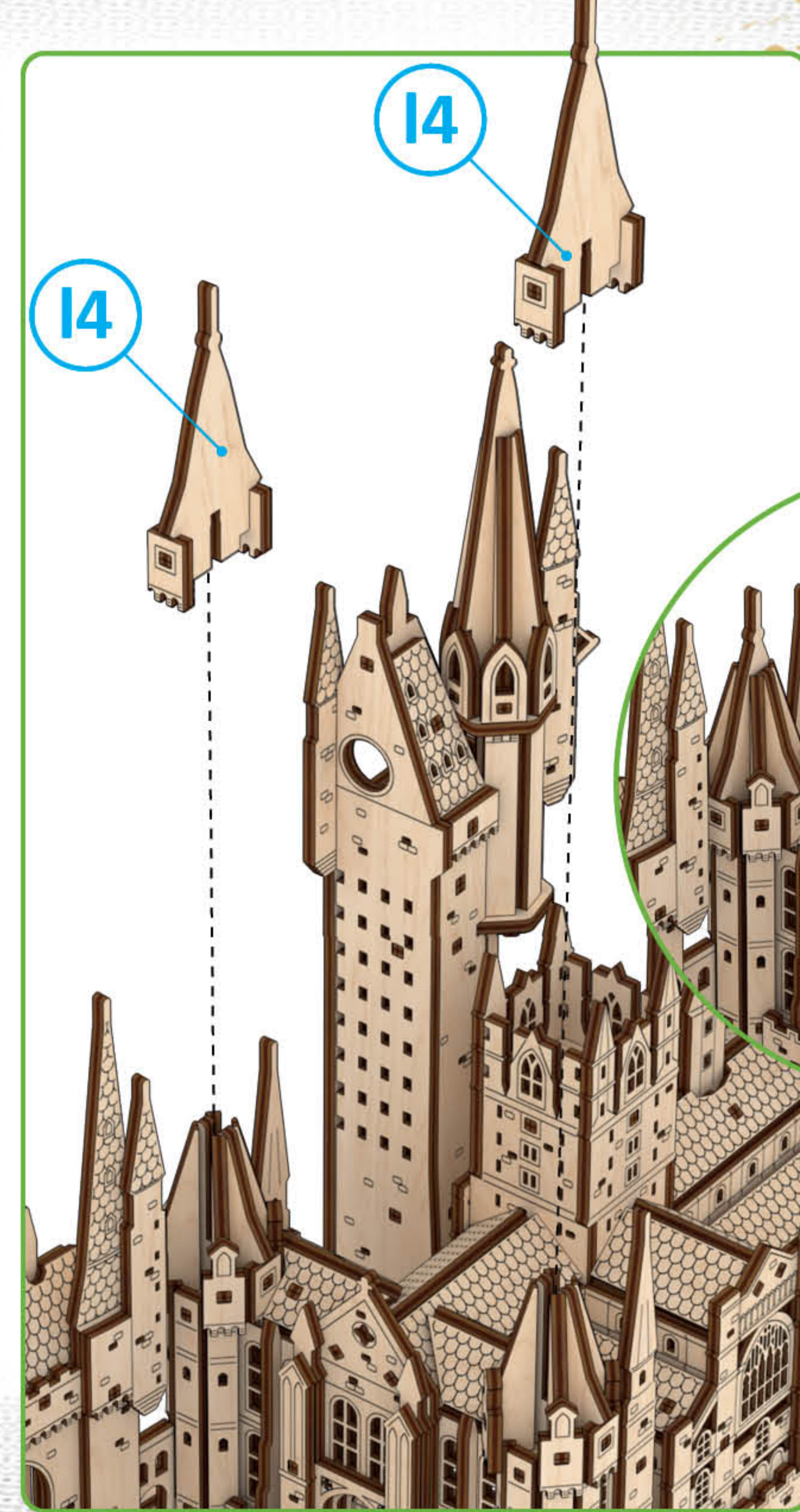

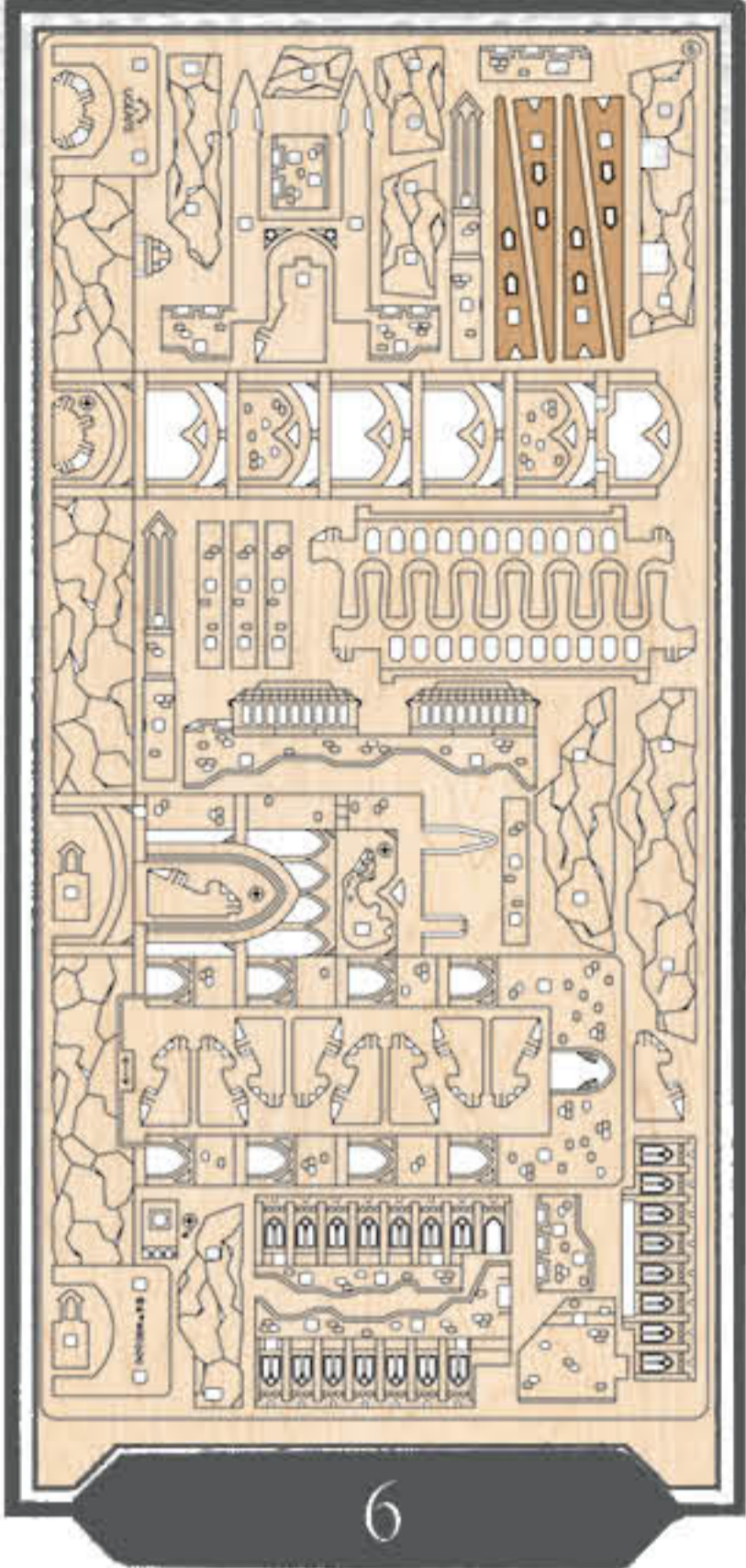

5

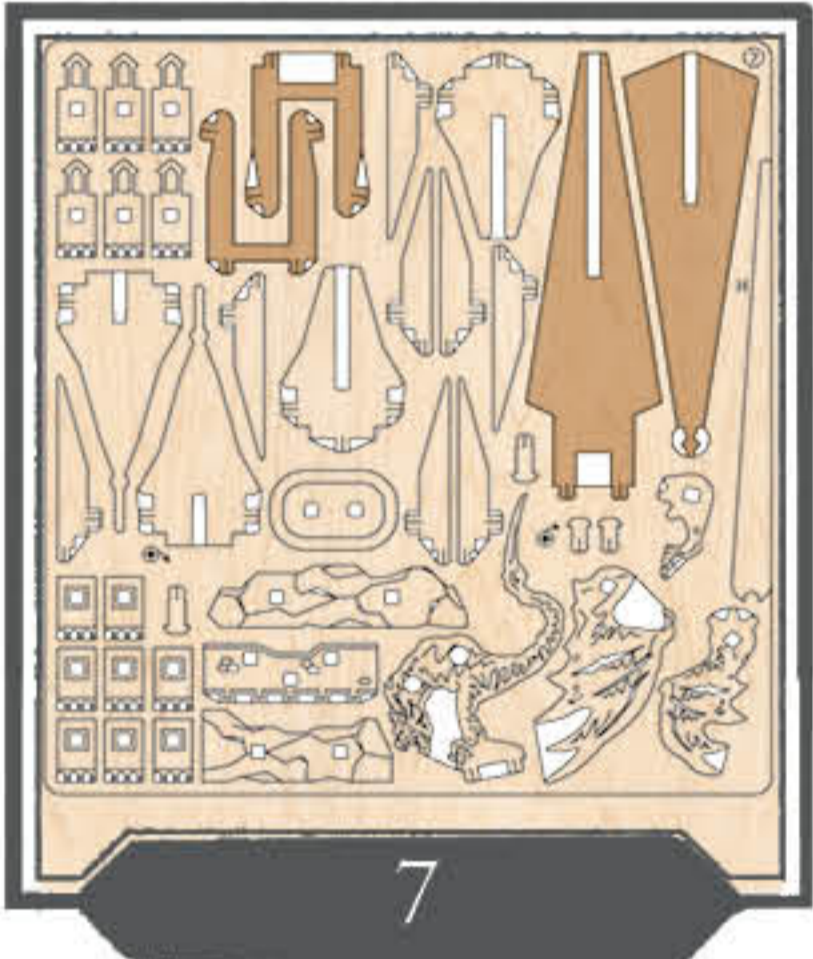
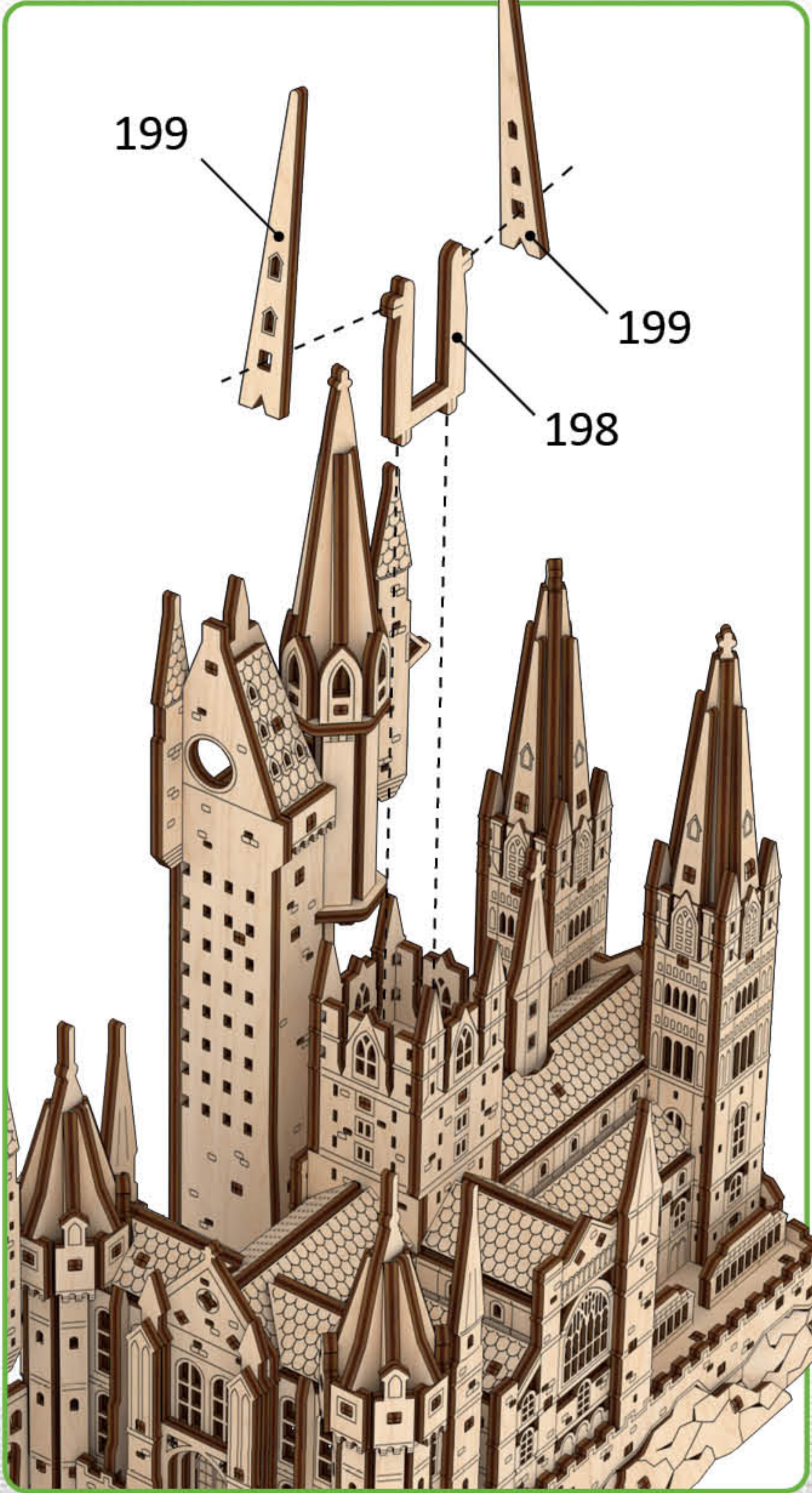

6

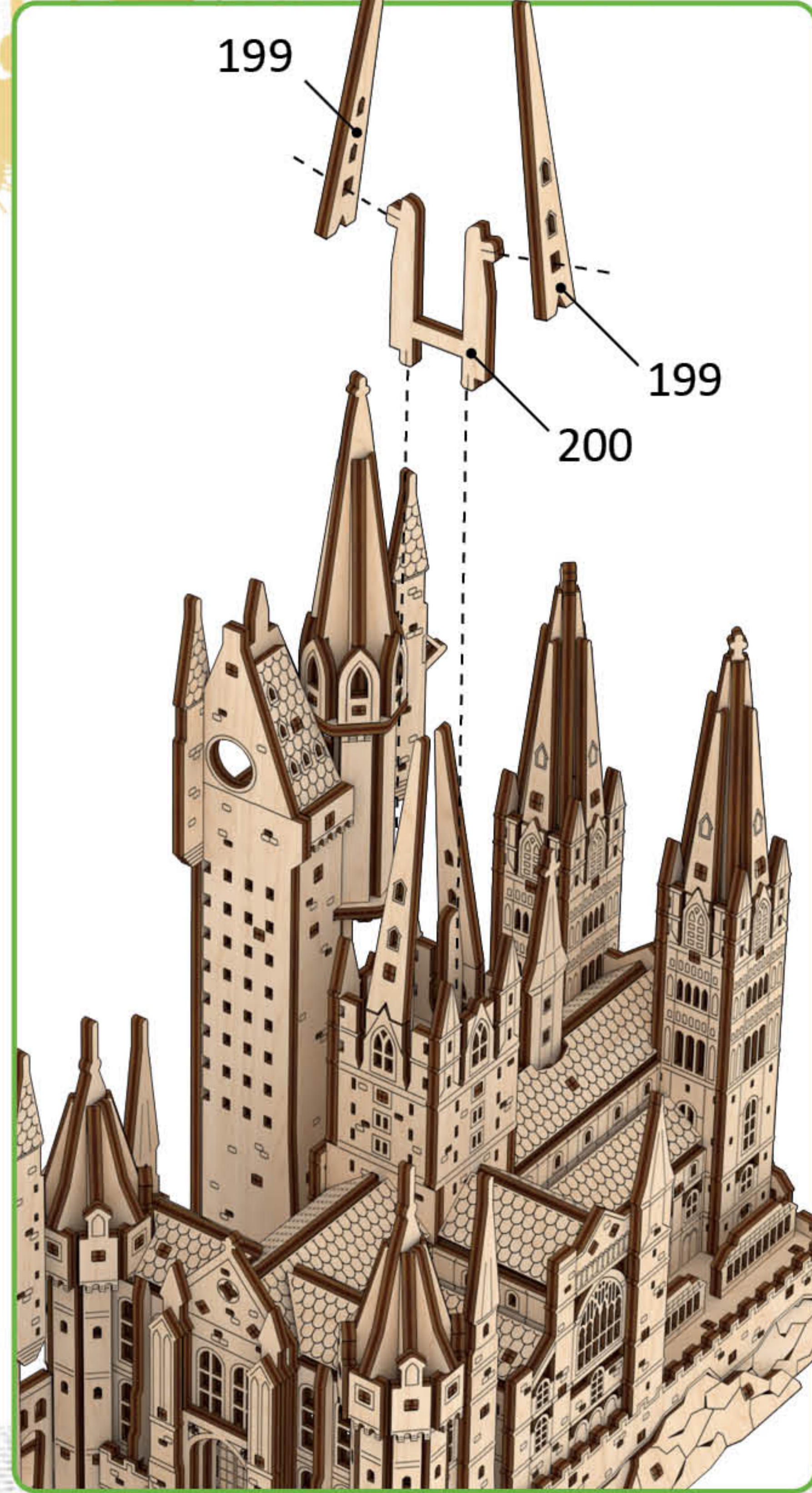

7

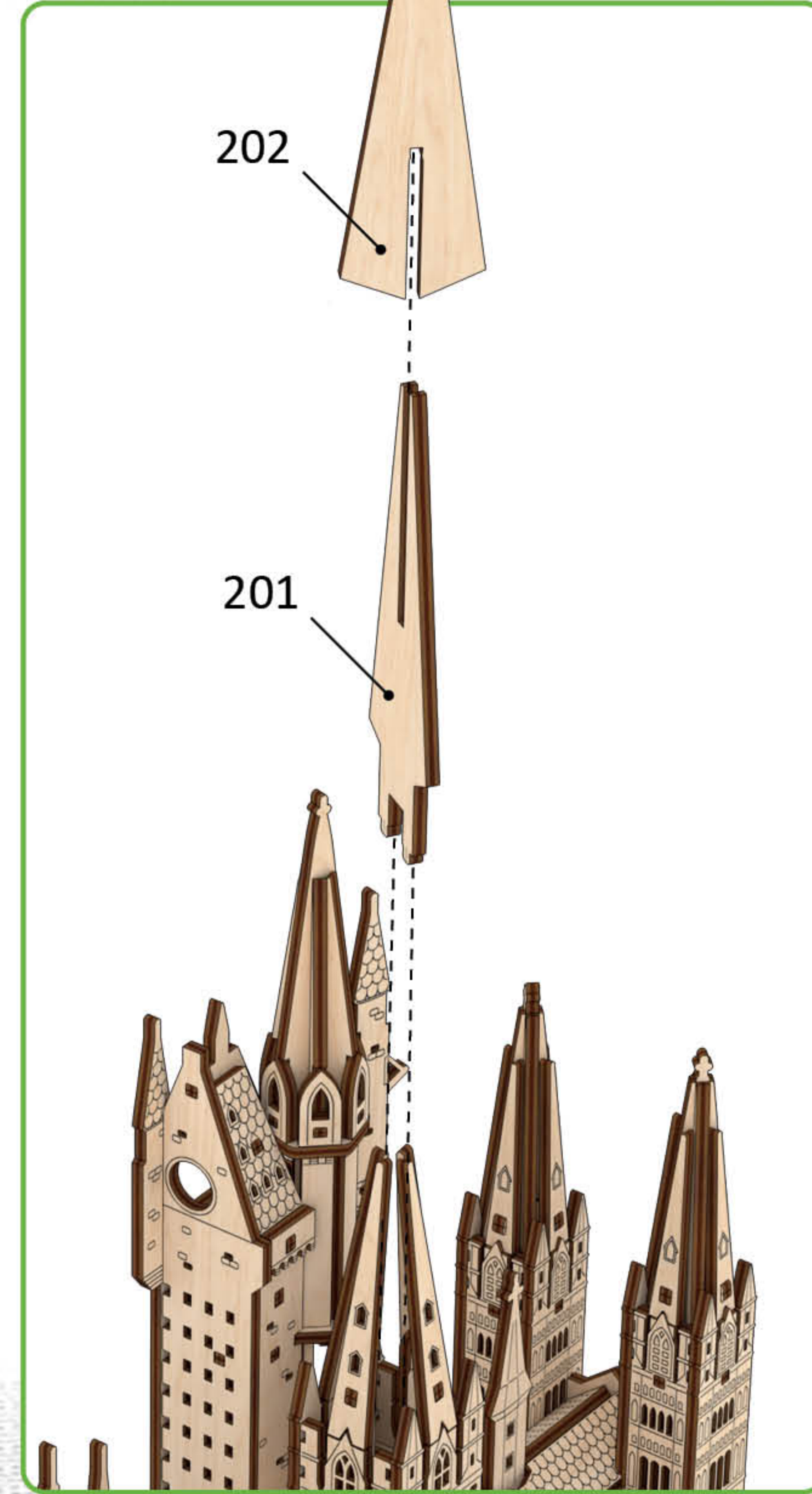

L

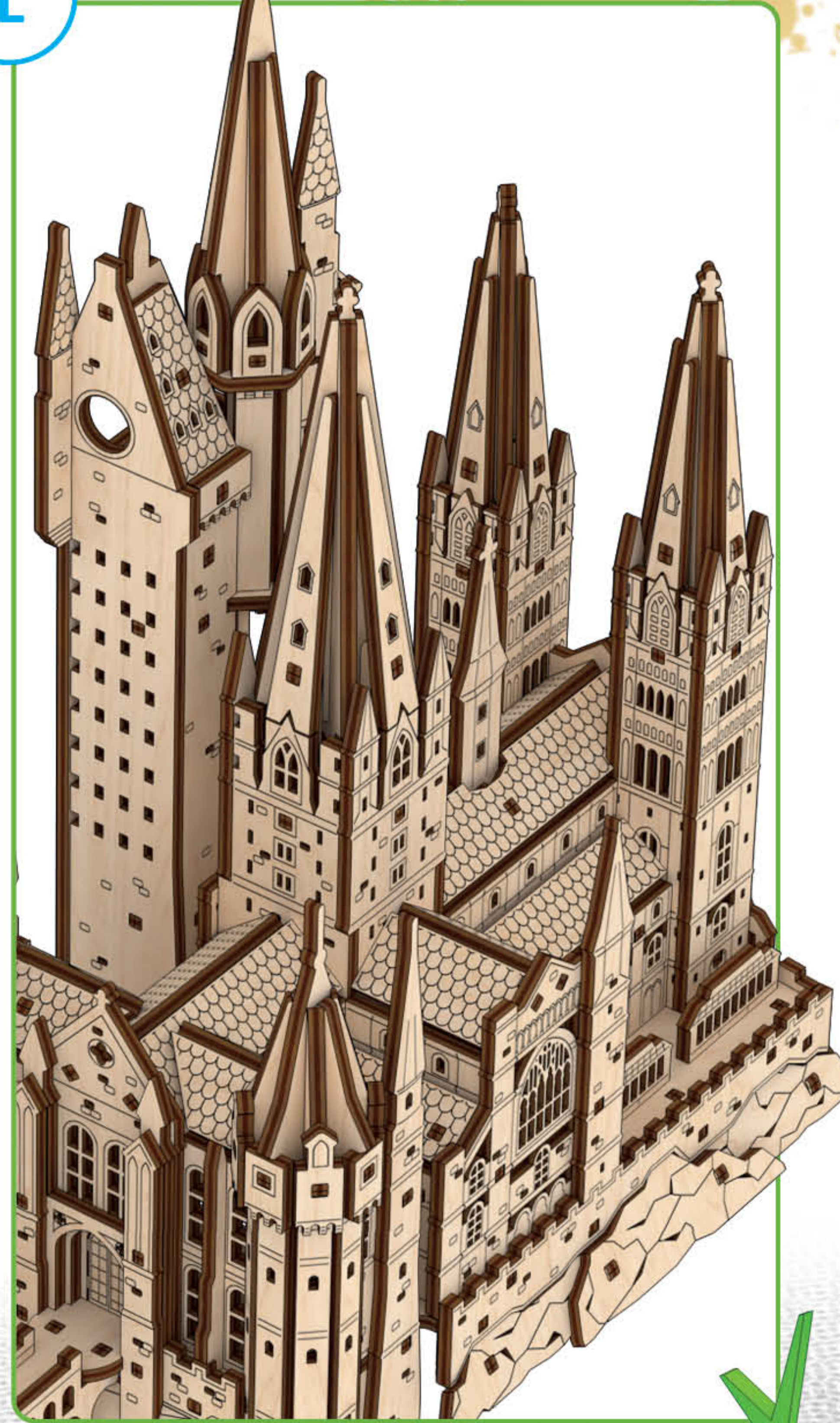

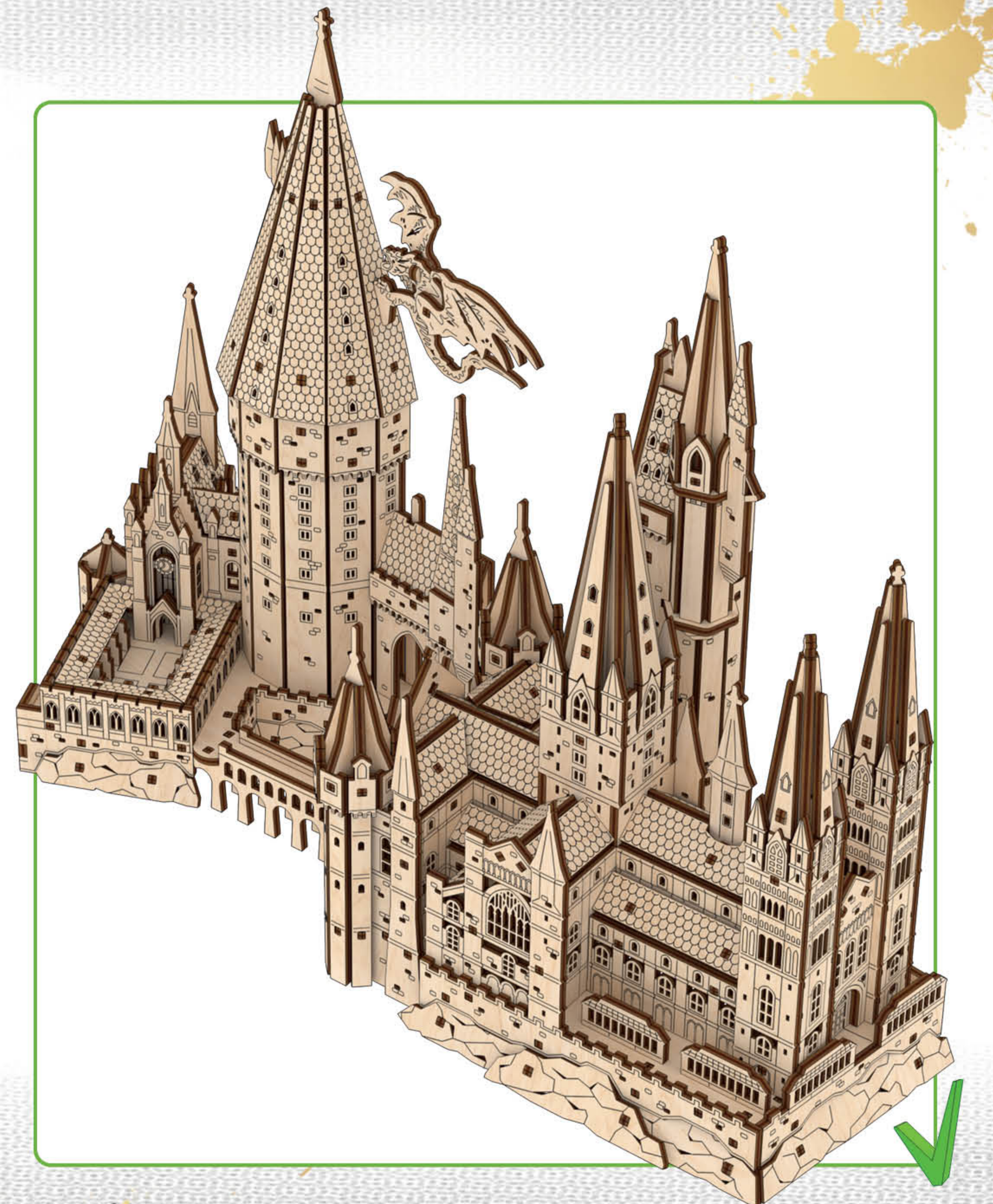
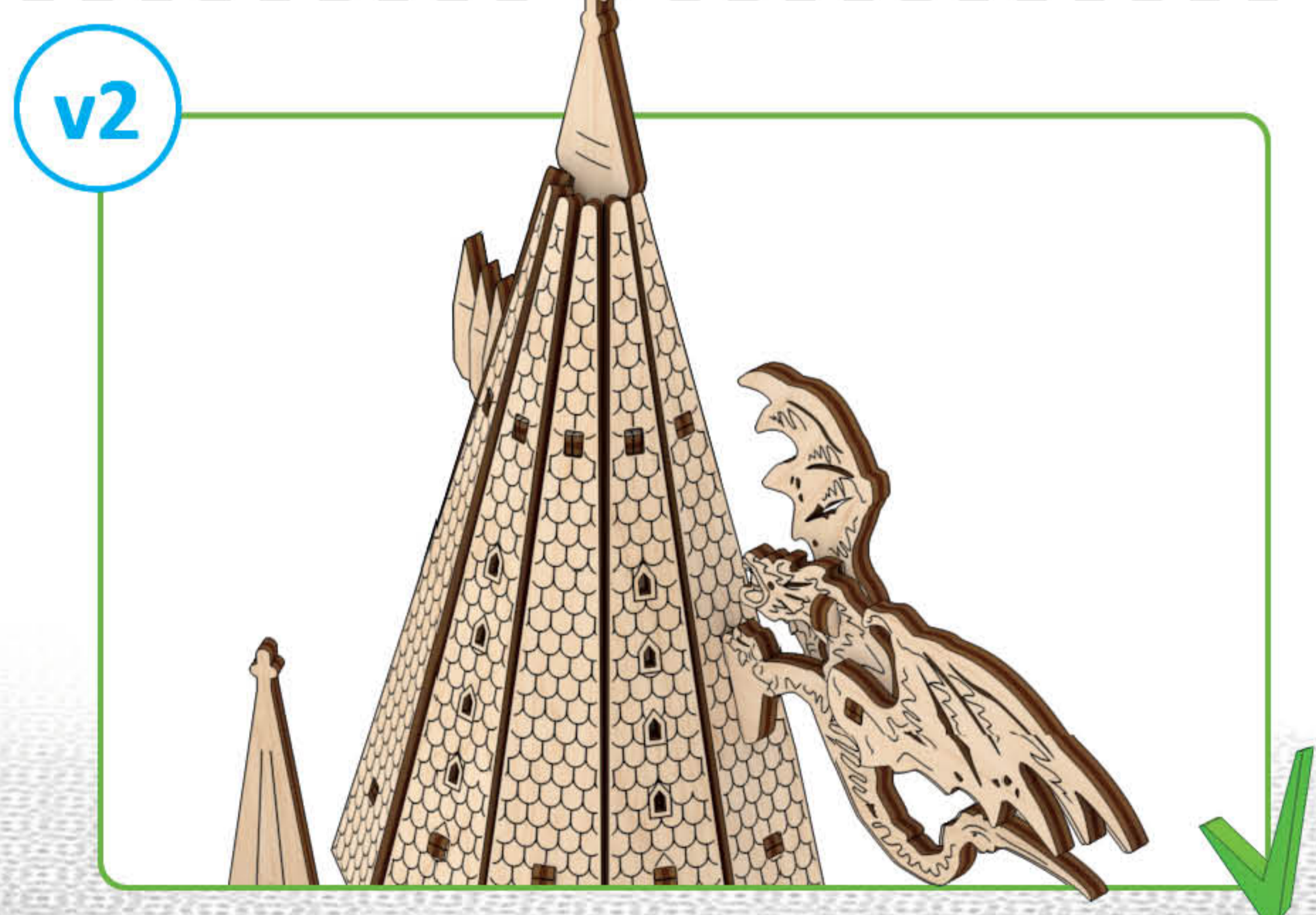
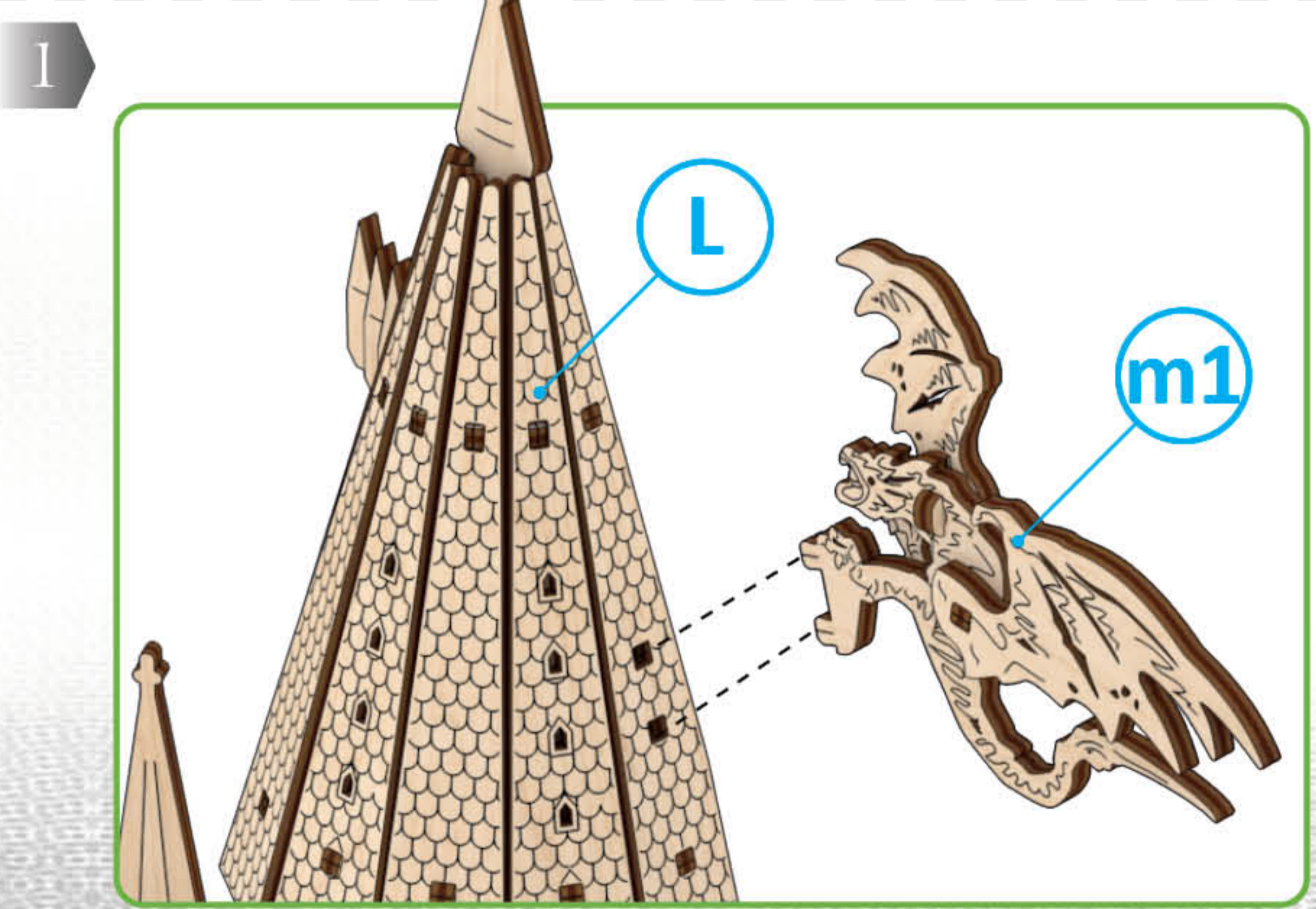
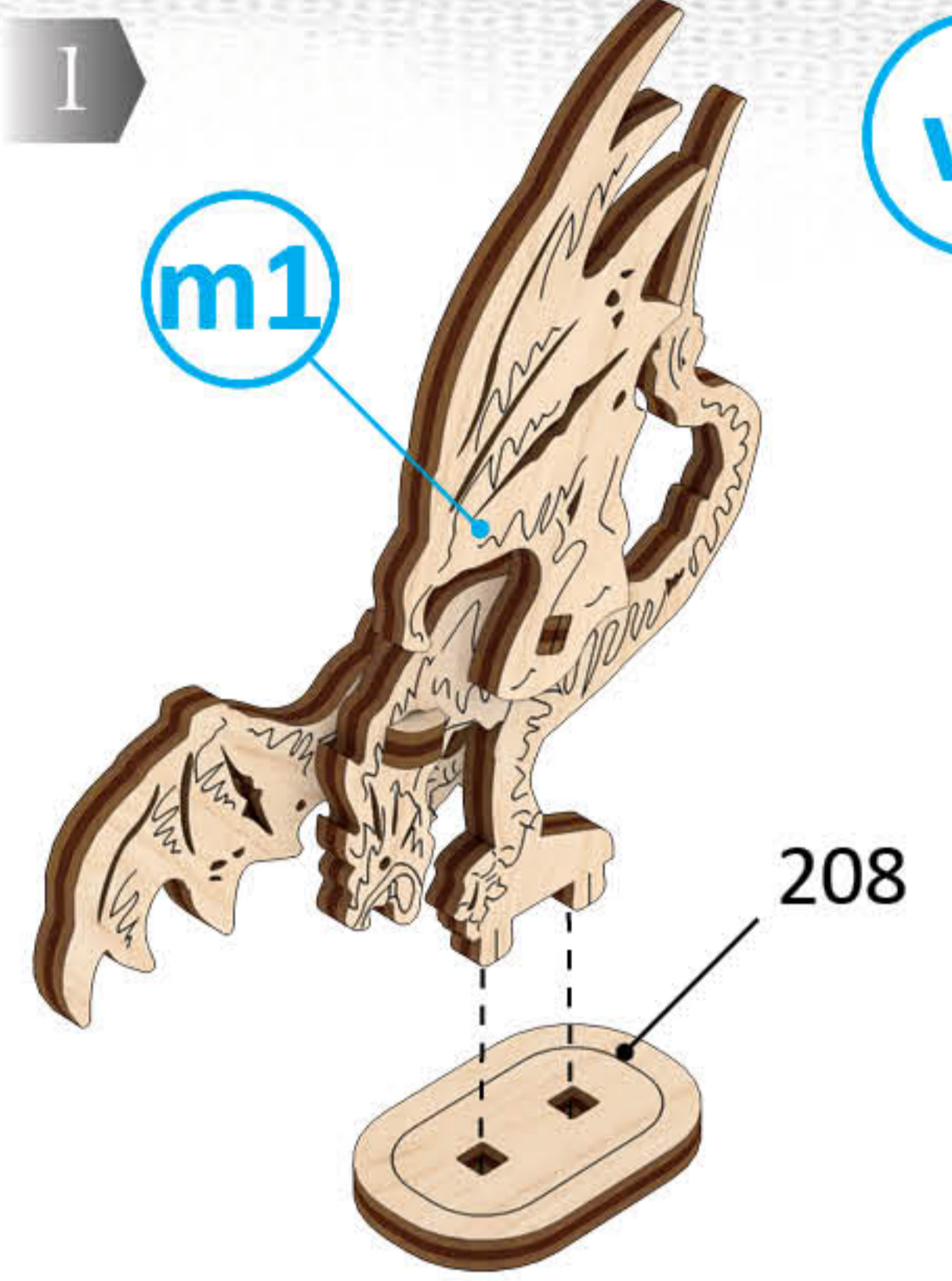
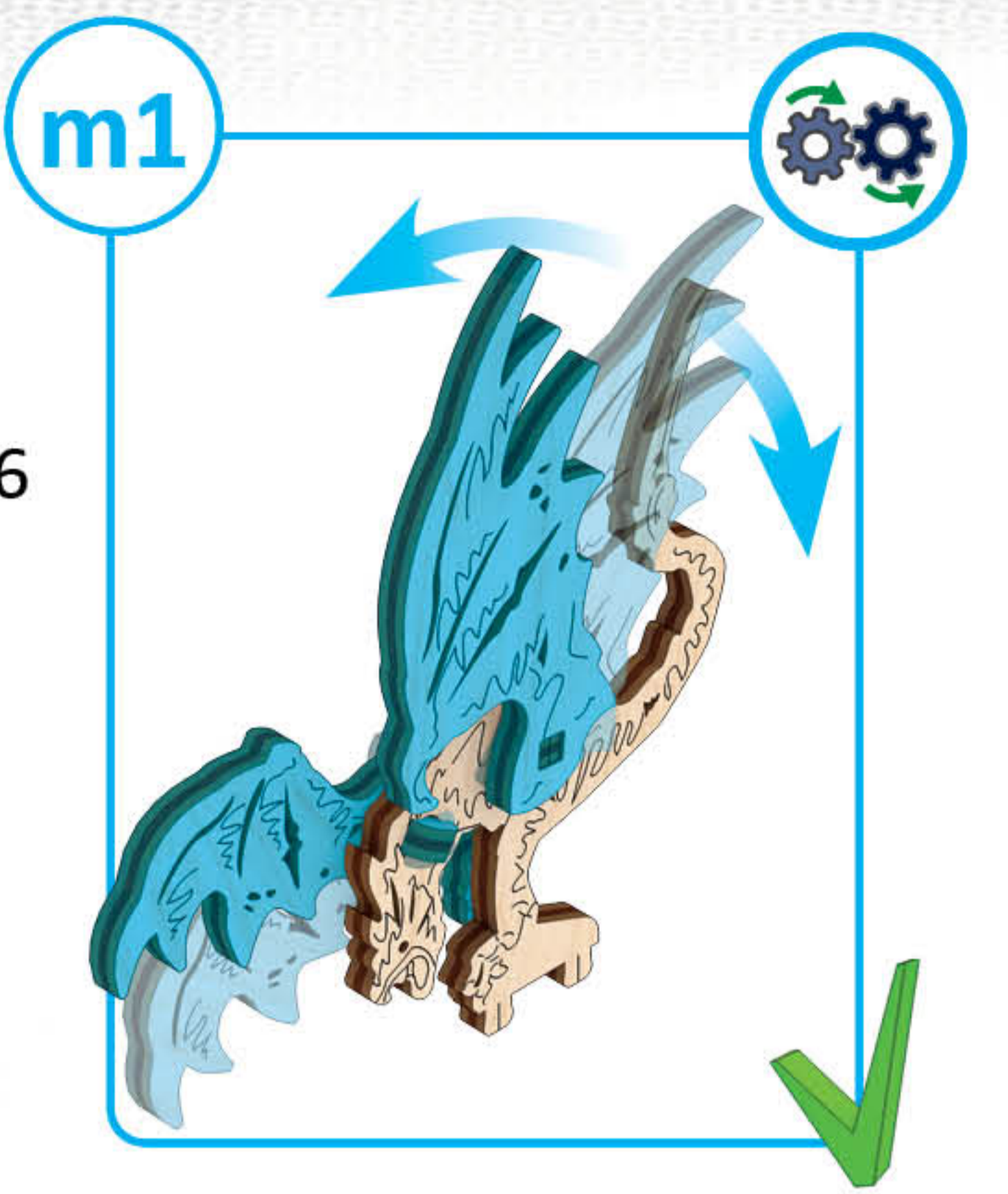
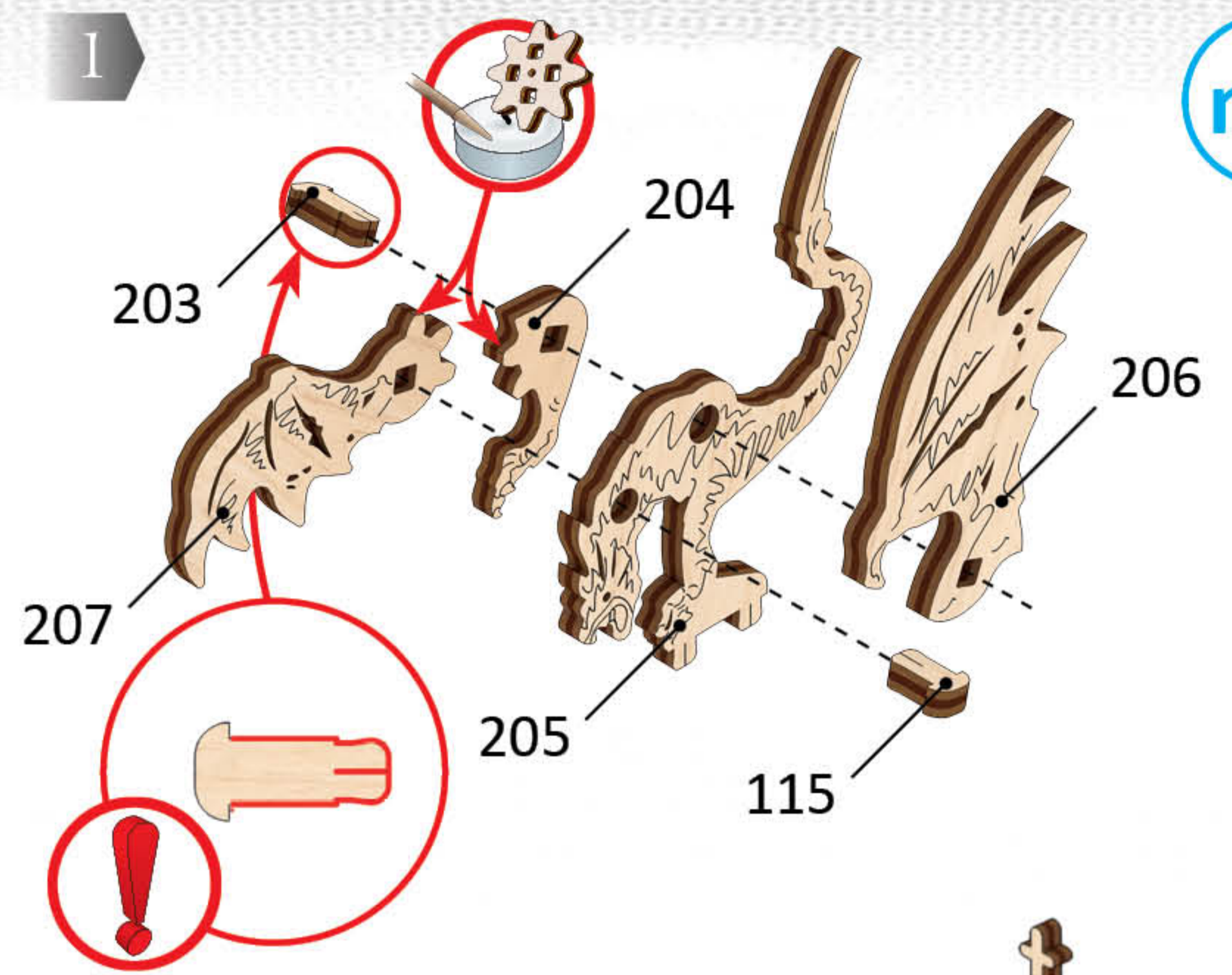

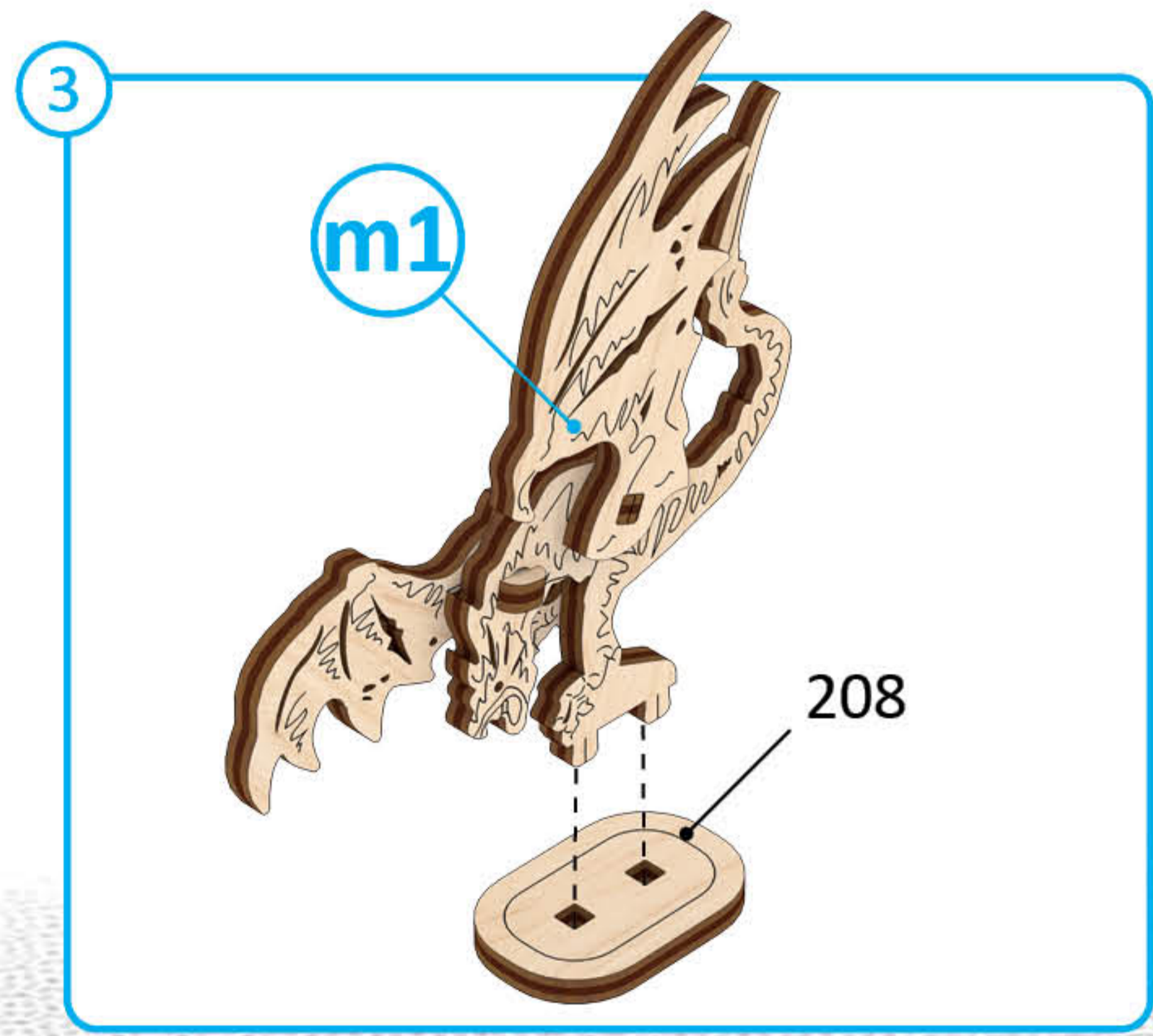
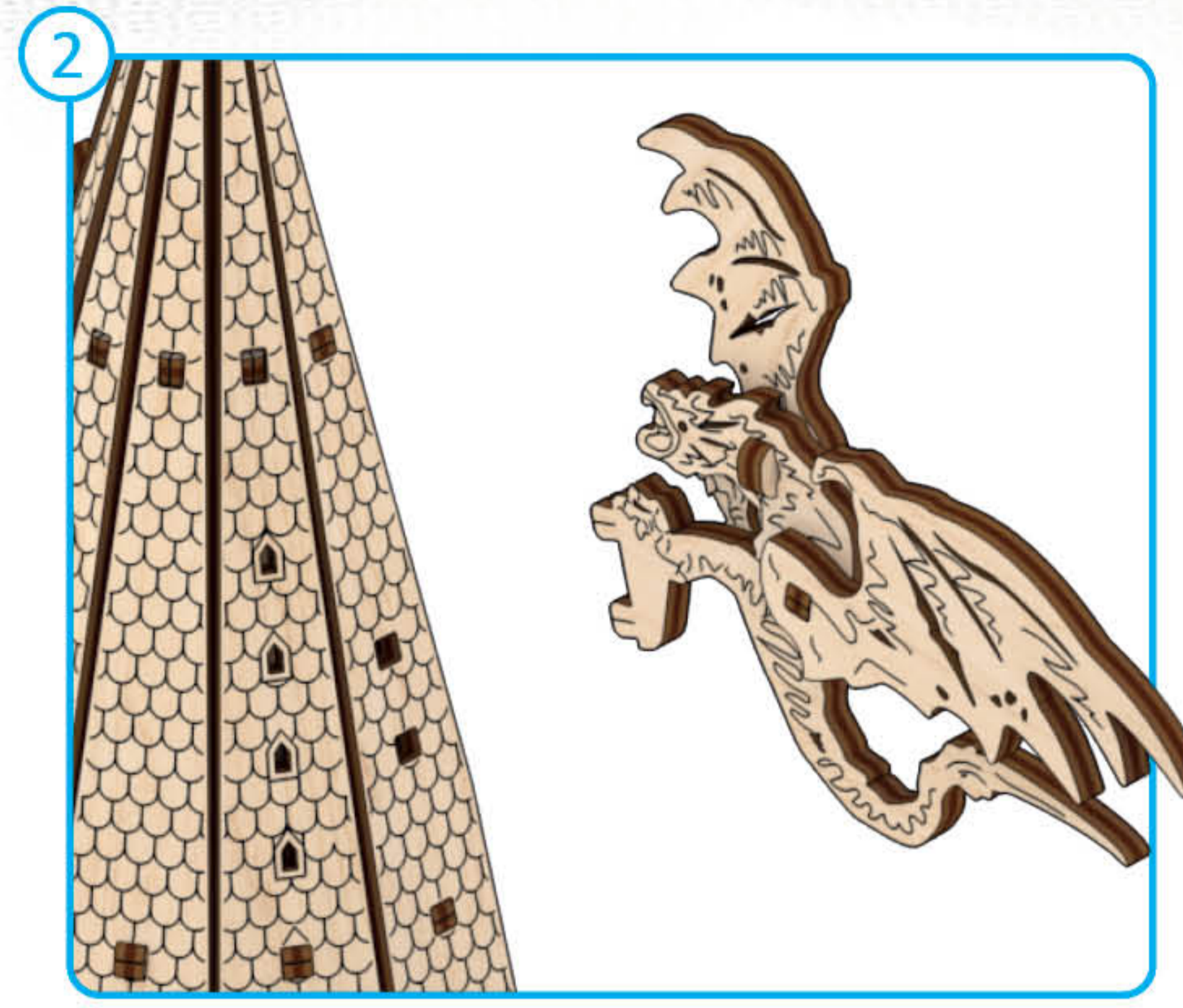
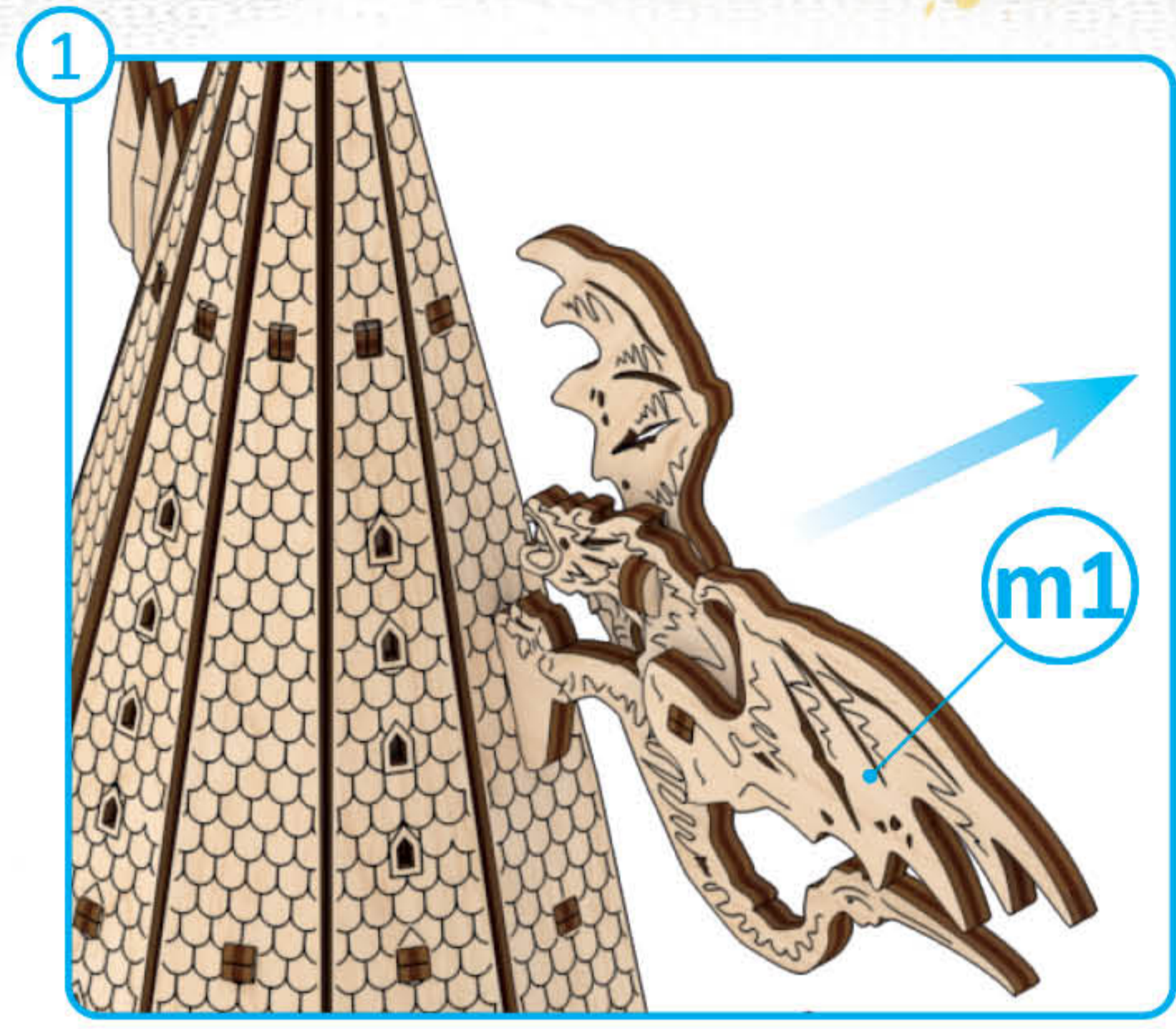
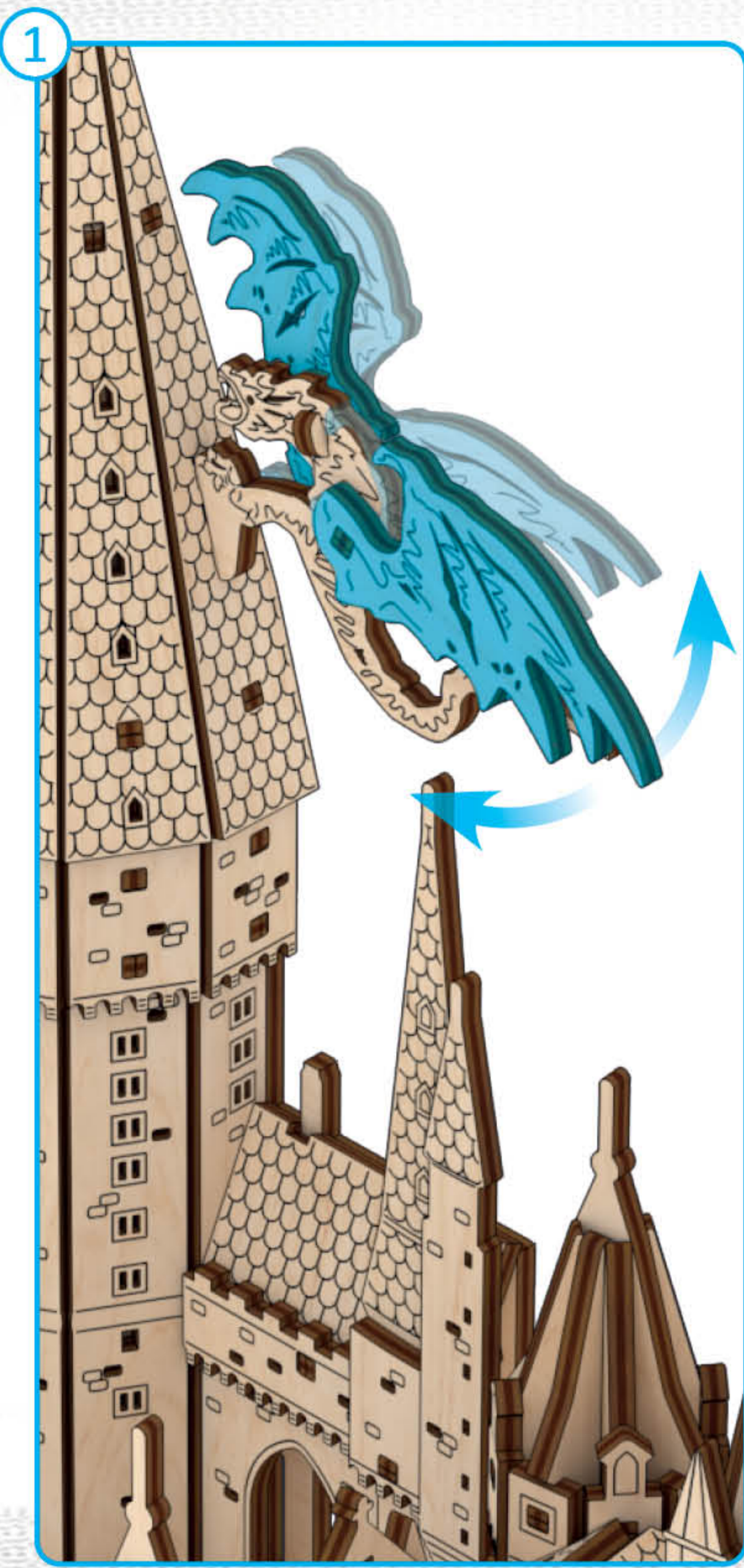
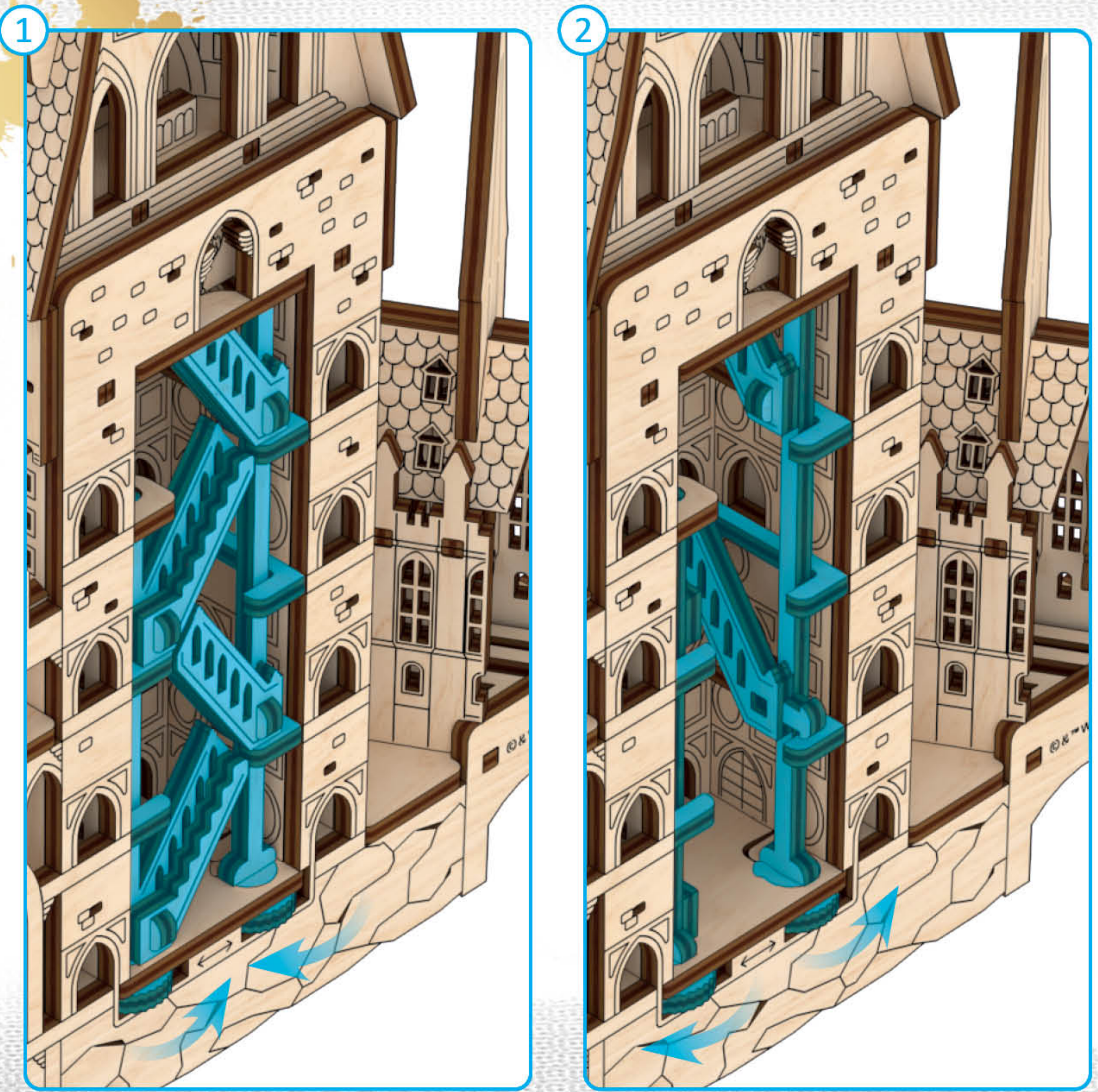

YOU MAY ALSO LIKE

Platform 9 3/4™

230

PARTS

3

HOURS

ASSEMBLY
TIME

MEDIUM

LEVEL



Quidditch™ Pinball

402

PARTS

9

HOURS

ASSEMBLY
TIME

ADVANCED

LEVEL



Golden Snitch™

120

PARTS

3

HOURS

ASSEMBLY
TIME

MEDIUM

LEVEL





ENG Thanks for following along on this journey with us. **UKR** Дякуємо, що ви пройшли цей шлях з нами. **FRA** Merci denous avoir accompagnés tout au long de ces étapes.
DEU Vielen Dank, dass Sie diesen Weg mit uns gegangen sind. **SPA** Gracias por haber recorrido el camino con nosotros. **ITA** Grazie per aver fatto uesto percorso con noi.
JPN UGEARSをご利用いただきありがとうございます **CHI** 感谢您参与有趣的模型拼装过程。 **POR** Obrigado seguir nesta jornada conosco.
POL Dziękujemy, że razem z nami pokonałeś tę drogę! **KOR** UGEARS 와 함께해 주셔서 감사합니다.

ENG Customer support **UKR** Служба підтримки
FRA Service client **DEU** Kundendienst
SPA Servicio al cliente **ITA** Servizio di supporto
JPN お客様窓口 **CHI** 客户支持
POR Atendimento ao cliente **POL** Wsparcie klienta
KOR 고객지원

customerservice@ugearsmodels.com

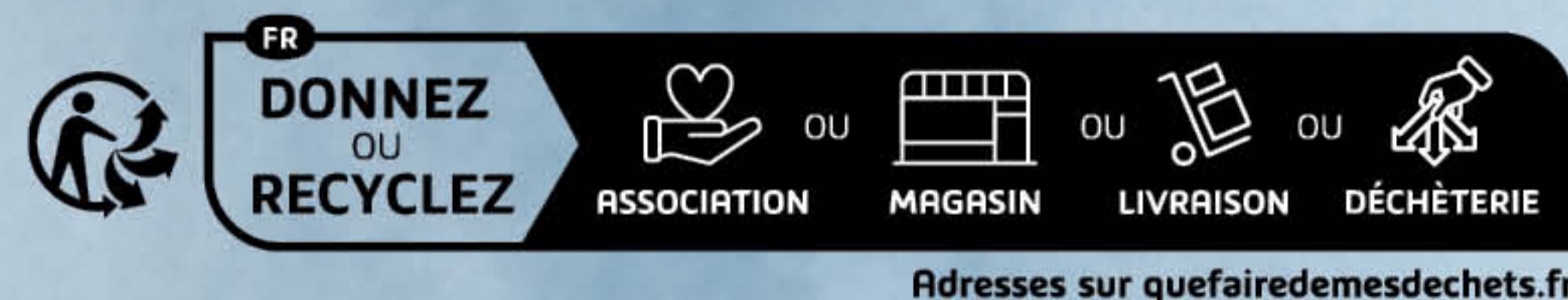

WIZARDING WORLD characters, names and related indicia are © & ™ Warner Bros. Entertainment Inc. WB SHIELD: © & ™ WBEI. Publishing Rights © JKR. (s24)

